

# 博士論文

## INTEGRATED ASSESSMENT OF ELECTRICITY DYNAMIC PRICING IN BUILDINGS

### 建物におけるダイナミックプライシング導入の 総合評価に関する研究

北九州市立大学国際環境工学研究科

2017年9月

張 瑤

Yao ZHANG



## **Preface**

This thesis research was performed at the Department of Architecture at The University of Kitakyushu. This thesis presents an interdisciplinary study which combines insights from the field of energy, policy, technology, and economic studies. The focus is set on the exploratory analysis of Kitakyushu consumers' response to electricity dynamic pricing and the integrated assessment of application of electricity dynamic pricing for different buildings. This study was supported and funded by MEXT, Japan (Kiban C, No. 2456072) during 2014 to 2017.



## **ACKNOWLEDGEMENTS**

This work could not have been completed without the support, guidance, and help of many people and institutions, for providing data and insights, for which I am very grateful.

I would like to extend my sincere gratitude to my supervisor, Professor Weijun Gao, for his support in many ways over the years and also for giving me the opportunity to study at the University of Kitakyushu. He has walked me through all the stages of the writing of this thesis. Without his constant encouragement and guidance, this thesis could not have reached its present form. Also, I would like to thank Prof. Ushifusa Yoshiaki for providing valuable data and information for research study in this thesis and the guidance about data processing.

I would also like to thank to all university colleagues, Dr. Xingzhi SHI, Dr Liyang Fan and Dr. Suapphong Kritsanawonghong – who gave me the guidance and research supports, Mr. Qun Ruan and Mr. Sawada Ryo for the collection of basic data, Dr. Jinming Jiang and Dr. Yanna Gao for numerous supports either research or daily life in Japan, and also the other fellow classmates (Jianan LIU, Danhua WU, Ming Xin, etc) who gave me their time in fulfilling my life along these years in Japan and helping me work out my problems during the difficult course of the thesis, I would also like to express my gratitude.

Also I would like to express my deepest thanks to my beloved husband and my lovely daughter, for their support, encouragement and kind company. My thanks also go to my parents for their loving considerations and great confidence in me that made me possible to finish this study.

Special thanks to MEXT, Japan (Kiban C, No. 24560724) for their great support on my study in Japan.



# **Integrated assessment of electricity dynamic pricing in buildings**

## **ABSTRACT**

The growing problems of traditional energy shortage and environmental pollution have become the biggest challenge facing the sustainable development of human society. According to the report and data from World Resources Institute, the worldwide greenhouse gas emissions (GHG) by sectors from 1990 to 2014 continues to increase even such kind of problems have already been called attention over the last two decades. What' more, it also tells that the GHG which caused by energy has accounts for majority of total GHG emissions. In the International Energy Outlook 2016 (IEO2016) Reference case, world energy-related CO<sub>2</sub> emissions increase from 32.3 billion metric tons in 2012 to 35.6 billion metric tons in 2020 and to 43.2 billion metric tons in 2040. The awareness of the environmental impact and the carbon footprint of all energy sectors keep increasing. In conjunction with this phenomenon, decarbonization has been put forward by many researchers and unions. Two elements are highlighted as important for decarbonization what are improved energy efficiency and increased shares of renewable energy. Utilize energy more efficiently at all stages of the energy chain from its production to its final consumption is meaningful for the reduction of GHG, and thereby to mitigate the climate change. Based on these important environmental issues, climate change impacts and renewed concerns over nuclear risks have heightened the urgency for transition to a low-carbon future. In order to solve such kind of problems, energy efficient technologies, renewable energy technologies, new transportation technologies and other low-carbon technologies will be rapidly developed, and have a large-scale application, which will brings the new challenge to the development and safe operation of electricity transmission and distribution network. Under this background, smart grid emerged at a historic moment and has been widely recognized in the world. Meanwhile, dynamic pricing as one of the most important parts of smart grids has also plays an essential role during the process of the innovation of energy systems.

This thesis reviewed the present situation of the development status and challenges of smart grids and dynamic pricing, meanwhile, investigated the introduction effect of dynamic pricing from an exploratory analysis of about 200 households and 50 offices that took part in dynamic pricing experiment in Kitakyushu, Japan. Following, this research analyzed the effects of electricity dynamic pricing on the cost performance of buildings in present scenario and demand response scenario. Then, according to the result, it gives an integrated analysis and evaluation of electricity dynamic pricing in buildings with different energy saving technologies.

Chapter 1, **PREVIOUS STUDY AND PURPOSE OF THE STUDY**, investigated current energy and environmental situations, as well as the electricity market and main electricity pricing system in different countries. In addition, the previous studies about this research are reviewed.

Chapter 2, **SURVEY ON THE DEVELOPMENT STATUS AND CHALLENGES OF SMART GRIDS AND DYNAMIC PRICING IN MAIN DRIVER COUNTRIES**, compares the development backgrounds and infrastructure status of various countries based on five aspects and presents an overview of the smart grid and the electricity dynamic pricing development situations in the main driver countries, discusses the research results produced by smart grid and electricity dynamic

pricing projects in different countries, summarizes their achievements and challenges, and provides a roadmap for national policy makers and power companies through which they can better orientates the development of smart grid and electricity dynamic pricing. This chapter also noting that America and Europe have the most similar development mode for SGs and DP and have already entered into a mature period, Japanese model of SG and DP development is a government-led, community-oriented, business-driven approach, China has the most unique SG and DP development structure compared with America, Europe, and Japan. A common problem that these countries face is a lack of clear related standards.

Chapter 3, **EXPLORATORY ANALYSIS OF KITAKYUSHU RESIDENTS RESPONSE TO DYNAMIC ELECTRICITY PRICING**, introduces the characteristic of Japanese dynamic pricing (DP) model of residents, meanwhile, summarizes the results from an exploratory analysis of about 200 households that took part in DP experiment in Kitakyushu, Japan. Using hourly load data collected from smart meter, tries to find statistically load reduction for participants during the DP time block. In addition, this chapter also discusses dynamic electricity pricing effect influenced by various factors, such as temperature, floor area of households, price level and residential consciousness.

Chapter 4, **EXPLORATORY ANALYSIS OF KITAKYUSHU OFFICES RESPONSE TO DYNAMIC ELECTRICITY PRICING**, selects some kinds of office buildings as a representative to introduce the characteristic of Japanese dynamic pricing (DP) model of office side. Meanwhile, it investigates the energy consumption of target office building, draw the conclusion that, the electricity usage of 2012 and 2013 is lower than that of 2010 and 2011 which due to the energy saving actions after the Great East Japan Earthquake as for all kinds of offices. Furthermore, this chapter estimates the effect of dynamic pricing system on the energy saving of office, concludes the load reduction for participants during the DP time block is occurred. It also discussed the dynamic electricity pricing effect related to temperature and the consciousness of employees. In addition, due to the loss of control group and experiment samples, standard baseline was also used to analyze the effect of DP in this chapter. The results show the well peak load reduction effect of DP through the comparison of the load curve of actual electricity use and baseline.

Chapter 5, **EVALUATION METHODS FOR ELECTRICITY DYNAMIC PRICING SYSTEM AND ENERGY SAVING TECHNOLOGIES**, proposes the evaluation system for the utilization of electricity dynamic pricing and energy saving technology in order to support its well introduction and deployment, introduces the main assessment criteria to estimate the overall performance of introducing energy saving technologies into the different alternative energy system of various buildings.

Chapter 6, **ANALYSIS OF THE EFFECTS OF ELECTRICITY DYNAMIC PRICING ON THE COST PERFORMANCE OF BUILDINGS IN PRESENT SCENARIO AND DEMAND RESPONSE SCENARIO**, investigates the effects of dynamic pricing system on the cost performance of different buildings in two scenarios, present scenario and demand response scenario. In the present scenario, this chapter gets the conclusion that, as for common consumers, dynamic pricing can't bring economic benefit to them if they have no obvious demand response. In the



demand response scenario, it can be drawn that even simple electricity saving actions, it also can realize amount of cost reduction for consumers who using dynamic pricing.

Chapter 7, **ANALYSIS AND EVALUATION OF ELECTRICITY DYNAMIC PRICING IN BUILDINGS WITH DIFFERENT ENERGY SAVING TECHNOLOGIES**, supposes the cases that introducing different energy saving technologies into customer side. Through the energy calculation model, draw the conclusion that it has the feasibility to introduce energy saving technologies into customer side to reduce extra fee caused by using DP. As for introduction of electricity saving technologies (PV or SB) into each building, select PV is better than SB in residential house, however, in hospital, office and hotel, different import objectives will result in different choice of facilities. As for introduction of energy saving technologies (distributed energy system) into the area, the energy system equipped with both DP and energy saving technologies will realize 15.3% percentage of annual cost saving. In the energy saving performance optimal case and environmental performance optimal case of distributed energy system, fuel cells and solar power generation which have high initial investment and high overall efficiency are adopted in order to improve energy saving effect and environmental friendliness. In the economy performance case, the gas engine with low initial investment was selected as the only power generation facility. The insufficient electricity demand is supplied by utility grid.

Chapter8, **CONCLUSIONS**, the whole summary of each chapter has been presented



## 張 瑤 博士論文の構成

### Integrated assessment of electricity dynamic pricing in buildings

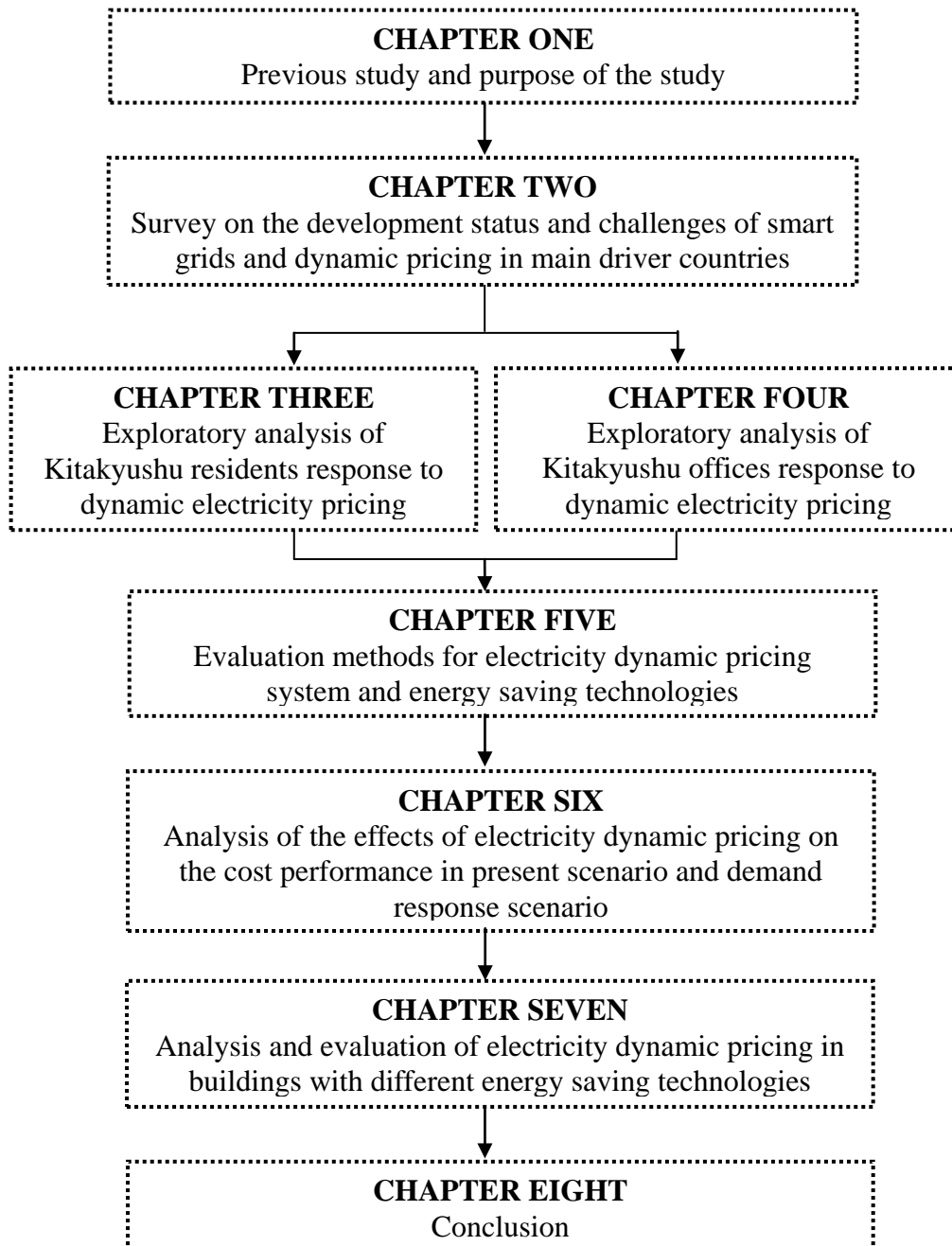



## TABLE OF CONTENTS

### ACKNOWLEDGEMENTS

### ABSTRACT

### STRUCTURE OF THIS PAPER

#### CHAPTER ONE: PREVIOUS STUDY AND PURPOSE OF THE STUDY

1.1 Introduction.....	1-1
1.2 Research Background and Significant.....	1-4
1.2.1 The relationship between environment and electricity.....	1-4
1.2.2 The introduction of electricity market.....	1-6
1.2.3 The introduction of electricity price in different country.....	1-8
1.3 Review of Previous Studies.....	1-17
1.3.1 Study on dynamic pricing system.....	1-17
1.3.2 Study on the implementation of dynamic pricing in building.....	1-18
1.4 Purpose of this study.....	1-19

#### CHAPTER TWO: SURVEY ON THE DEVELOPMENT STATUS AND CHALLENGES OF SMART GRIDS AND DYNAMIC PRICING IN MAIN DRIVER COUNTRIES

2.1 Introduction.....	2-1
2.2 Survey on the Development Status and Challenges of Smart Grids.....	2-3
2.2.1 Basic information of Smart Grids.....	2-3
2.2.2 Development background and infrastructure of Smart Grids.....	2-7
2.2.3 Development status and achievements of Smart Grids.....	2-9
2.3 Survey on the Development Status and Challenges of Dynamic Pricing.....	2-21
2.3.1 Basic information of dynamic price.....	2-22
2.3.2 Main method of demand response and electricity dynamic pricing....	2-24
2.3.3 Development status and achievements of dynamic price.....	2-30
2.4 Barriers and Challenges of Smart Grids and Dynamic Pricing.....	2-33
2.5 Summary.....	2-36

#### CHAPTER THREE: EXPLORATORY ANALYSIS OF KITAKYUSHU RESIDENTS RESPONSE TO DYNAMIC ELECTRICITY PRICING

3.1 Introduction.....	3-1
3.2 Database of Residents in Kitakyushu Smart Community Project.....	3-2
3.2.1 Basic information of the project.....	3-4
3.2.2 Information of resident group in the project.....	3-7
3.2.3 Electricity pricing system of residents in the project.....	3-14
3.3 Energy Consumption of the Target Residential House.....	3-18
3.3.1 The yearly electricity consumption.....	3-18
3.3.2 The monthly electricity consumption.....	3-23
3.3.3 The hourly electricity consumption.....	3-27

3.4	Evaluation of Residents Response to Dynamic Electricity Pricing.....	3-30
3.4.1	Dynamic electricity pricing effect influenced by temperature.....	3-30
3.4.2	Dynamic electricity pricing effect influenced by floor area.....	3-32
3.4.3	Dynamic electricity pricing effect influenced by price level.....	3-33
3.4.4	Dynamic electricity pricing effect influenced by consciousness.....	3-34
3.5	Summary.....	3-37

## **CHAPTER FOUR: EXPLORATORY ANALYSIS OF KITAKYUSHU OFFICES RESPONSE TO DYNAMIC ELECTRICITY PRICING**

4.1	Introduction.....	4-1
4.2	Database of Offices in Kitakyushu Smart Community Project.....	4-2
4.2.1	Basic information of the project.....	4-2
4.2.2	Information of office group in the project.....	4-3
4.2.3	Electricity pricing system of offices in the project.....	4-4
4.3	Energy Consumption of the Target Offices.....	4-7
4.3.1	Energy Consumption in Complex Commercial Building.....	4-7
4.3.2	Energy Consumption in Office.....	4-11
4.3.3	Energy Consumption in Retail store.....	4-14
4.3.4	Energy Consumption in Manufacturing Industry.....	4-17
4.3.5	Energy Consumption in Medical & Social Welfare.....	4-20
4.3.6	Energy Consumption in Education Support Facility.....	4-23
4.4	Evaluation of Offices Response to Dynamic Electricity Pricing.....	4-25
4.4.1	Dynamic electricity pricing effect related to temperature.....	4-25
4.4.2	Dynamic electricity pricing effect related to standard baseline.....	4-28
4.4.3	Dynamic electricity pricing effect related to people's consciousness.....	4-32
4.5	Summary.....	4-34

## **CHAPTER FIVE: EVALUATION METHODS FOR ELECTRICITY DYNAMIC PRICING SYSTEM AND ENERGY SAVING TECHNOLOGIES**

5.1	Introduction.....	5-1
5.2	Overview of the evaluation method.....	5-2
5.2.1	Overview of the evaluation method for dynamic pricing system.....	5-2
5.2.2	Overview of the evaluation method for energy saving technologies..	5-5
5.3	Methodology for evaluation.....	5-8
5.3.1	Description of the energy system.....	5-8
5.3.2	Methodology for evaluating electricity dynamic pricing system.....	5-10
5.3.3	Methodology for evaluating energy saving technologies.....	5-10
5.4	Assessment criteria.....	5-13
5.4.1	Assessment for economy performance.....	5-13
5.4.2	Assessment for energy performance.....	5-15
5.4.3	Assessment for environmental performance.....	5-16
5.5	Summary.....	5-17

## **CHAPTER SIX: ANALYSIS OF THE EFFECTS OF ELECTRICITY DYNAMIC PRICING ON THE COST PERFORMANCE OF BUILDINGS IN PRESENT SCENARIO AND DEMAND RESPONSE SCENARIO**

6.1	Introduction.....	6-1
6.2	Effects of DP on the Cost Performance of Buildings in Present Scenario...	6-2
6.2.1	The case of residential house.....	6-2
6.2.1.1	Electricity load of residential house.....	6-2
6.2.1.2	Electricity price of residential house.....	6-2
6.2.1.3	Cost performance of DP in residential house.....	6-4
6.2.2	The case of hospital.....	6-5
6.2.2.1	Electricity load of hospital.....	6-5
6.2.2.2	Electricity price of hospital.....	6-5
6.2.2.3	Cost performance of DP in hospital.....	6-7
6.2.3	The case of office.....	6-8
6.2.3.1	Electricity load of office.....	6-8
6.2.3.2	Electricity price of office.....	6-8
6.2.3.3	Cost performance of DP in office.....	6-8
6.2.4	The case of hotel.....	6-11
6.2.4.1	Electricity load of hotel.....	6-11
6.2.4.2	Electricity price of hotel.....	6-11
6.2.4.3	Cost performance of DP in hotel.....	6-11
6.3	Effects of DP on the Cost Performance of Buildings in DR Scenario.....	6-13
6.3.1	The case of residential house.....	6-14
6.3.1.1	Introduction of energy saving actions in residential house.....	6-15
6.3.1.2	Electricity cost reduction effect of different actions.....	6-20
6.3.2	The case of hospital.....	6-21
6.3.2.1	Introduction of energy saving actions in hospital.....	6-21
6.3.2.2	Electricity cost reduction effect of different actions.....	6-24
6.3.3	The case of office.....	6-25
6.3.3.1	Introduction of energy saving actions in office.....	6-25
6.3.3.2	Electricity cost reduction effect of different actions.....	6-29
6.3.4	The case of hotel.....	6-30
6.3.4.1	Introduction of energy saving actions in hotel.....	6-30
6.3.4.2	Electricity cost reduction effect of different actions.....	6-31
6.4	Summary.....	6-34

## **CHAPTER SEVEN: ANALYSIS AND EVALUATION OF ELECTRICITY DYNAMIC PRICING IN BUILDINGS WITH DIFFERENT ENERGY SAVING TECHNOLOGIES**

7.1	Introduction.....	7-1
7.2	Introduction of energy saving technologies.....	7-2
7.2.1	Introduction of storage battery.....	7-2
7.2.2	Introduction of photovoltaic.....	7-4

7.2.3 Introduction of distributed energy system.....	7-5
7.3 Case study 1- Analysis and evaluation of DP in residential house.....	7-6
7.3.1 Case setting.....	7-6
7.3.2 Analysis results and discussion.....	7-6
7.4 Case study 2- Analysis and evaluation of DP in Hospital.....	7-12
7.4.1 Case setting.....	7-12
7.4.2 Analysis results and discussion.....	7-12
7.5 Case study 3- Analysis and evaluation of DP in office.....	7-17
7.5.1 Case setting.....	7-17
7.5.2 Analysis results and discussion.....	7-17
7.6 Case study 4- Analysis and evaluation of DP in hotel.....	7-20
7.6.1 Case setting.....	7-20
7.6.2 Analysis results and discussion.....	7-20
7.7 Case study 5- Analysis and evaluation of DP in community.....	7-23
7.7.1 Case setting.....	7-23
7.7.2 Analysis results and discussion.....	7-25
7.8 Summary.....	7-30

## **CHAPTER EIGHT: CONCLUSIONS**



## **CHAPTER ONE: PREVIOUS STUDY AND PURPOSE OF THE STUDY**

### 1.1 Introduction

### 1.2 Research Background and Significant

1.2.1 The relationship between environment and electricity

1.2.2 The introduction of electricity market

1.2.3 The introduction of electricity price in different country

### 1.3 Review of Previous Studies

1.3.1 Study on dynamic pricing system

1.3.2 Study on the implementation of dynamic pricing in building

### 1.4 Purpose of this study



### 1.1 Introduction

The growing problems of traditional energy shortage and environmental pollution have become the biggest challenge facing the sustainable development of human society. Figure 1-1 displays the worldwide greenhouse gas emissions (GHG) by sectors from 1990 to 2010. It can suggest that the emissions continues to increase even such kind of problems have already been called attention over the last two decades. What's more, it also shows us that the GHG which caused by energy has accounts for majority of total GHG emissions. Figure 1-2 shows the electricity price in select country. It is obvious that the electricity cost continues an increasing trend in recent years. Figure 1-3 is the electricity production from renewable sources which excluding hydroelectric and including geothermal, solar, tides, wind, biomass, and bio-fuels. It illustrates that the electricity production from renewable sources have increased by around 10 times in 2013 compared to 2005 and it still not reached a record-breaking level. Based on these important environmental issues, climate change impacts, rising energy costs, and renewed concerns over nuclear risks have heightened the urgency for transition to a low-carbon future.

In order to solve such kind of problems, energy efficient technologies, renewable energy technologies, new transportation technologies and other low-carbon technologies will be rapidly developed, and have a large-scale application. Besides, a variety of such kind of technologies focused on renewable energy generation and end-user sides which result in the dramatically change in generating side and consumer side of traditional power grid. Moreover, bring the new challenge to the development and safe operation of electricity transmission and distribution network. Under this background, smart grid emerged at a historic moment and has been widely recognized in the world. Meanwhile, dynamic pricing as one of the most important parts of smart grids has also plays an essential role during the process of the innovation of energy systems.

Generally speaking, dynamic pricing system can give consumers powerful incentives to consume less when the system was highly stressed and wholesale prices were very high [7]. It is a kind of pricing structure that has the potential to flatten demand profiles and thus help power suppliers to reduce expenditure on capacity addition and efficiently plan electricity generation and distribution. It is also a demand response method which needs the participation of both consumers and the power supply enterprises. It is more economic than the time-invariant pricing. End-users have incentives to respond to short-term price variations by reducing peak consumption or by shifting peak consumption to off-peak periods. What's more, dynamic price can help optimal electricity market in four important and interrelated ways. First, Dynamic price can be used to manage system reliability by decreasing purchases through periods of low supply or high congestion. Second, dynamic price can lower wholesale market prices by decreasing the need for output from high cost peaking generators. Third, dynamic price is expected to mitigate market power by providing a counteracting force to the withholding of capacity. Finally, dynamic price can be used to maintain system resource adequacy.

This research reviewed the present situation of the development status and challenges of smart grids and dynamic pricing, meanwhile, investigated the introduction effect of dynamic pricing from an exploratory analysis of about 200 households and 50 offices that took part in dynamic pricing experiment in Kitakyushu, Japan. Following, this research analyzed the effects of electricity dynamic pricing on the cost performance of buildings in present scenario and demand response scenario. Then, according to the result, it gives an integrated analysis and evaluation of electricity dynamic pricing in buildings with different energy saving technologies

CHAPTER ONE: PREVIOUS STUDY AND PURPOSE OF THE STUDY

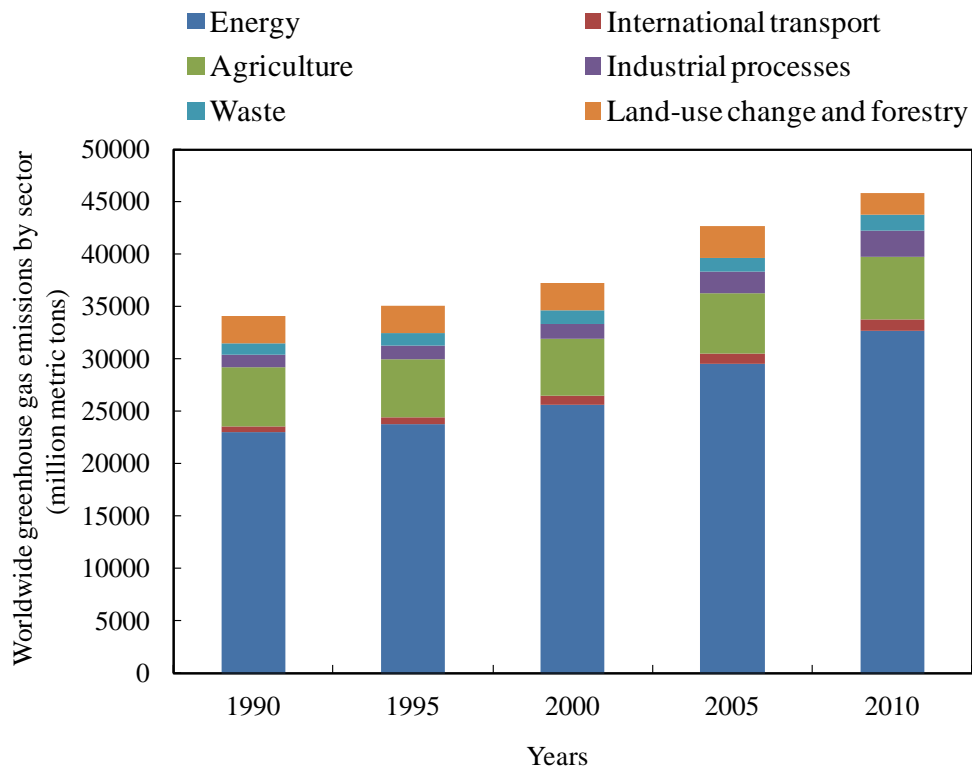

Figure 1-1 Worldwide greenhouse gas emissions by sector

(Source: World Resources Institute, 2014; Food and Agriculture Organization, 2014.)

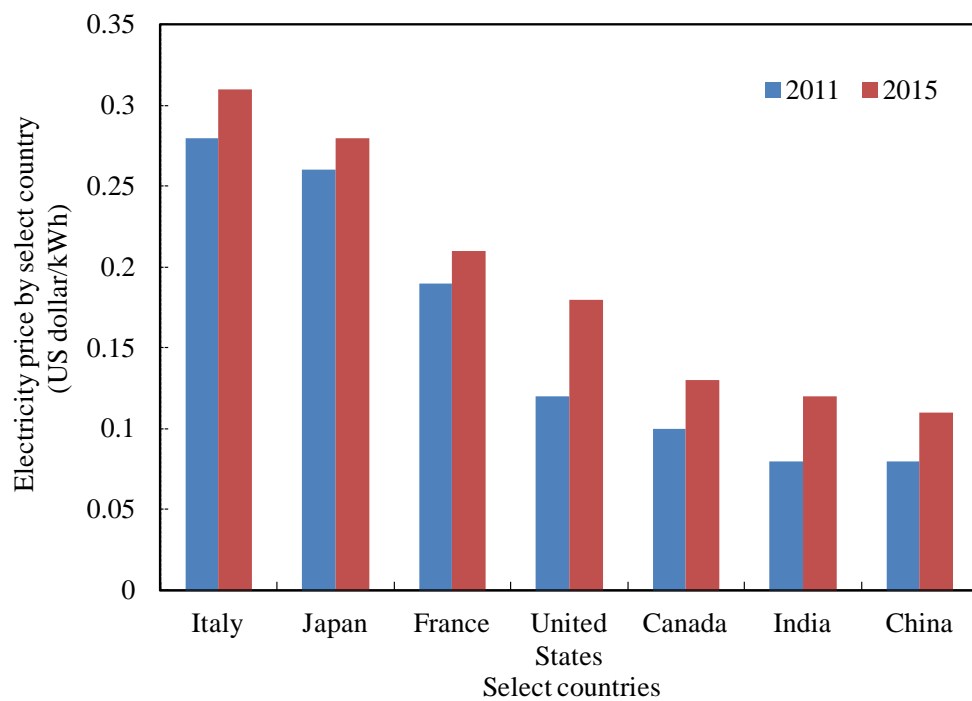

Figure 1-2 Electricity price by select country

(Source: The Statistics Portal, 2016.)

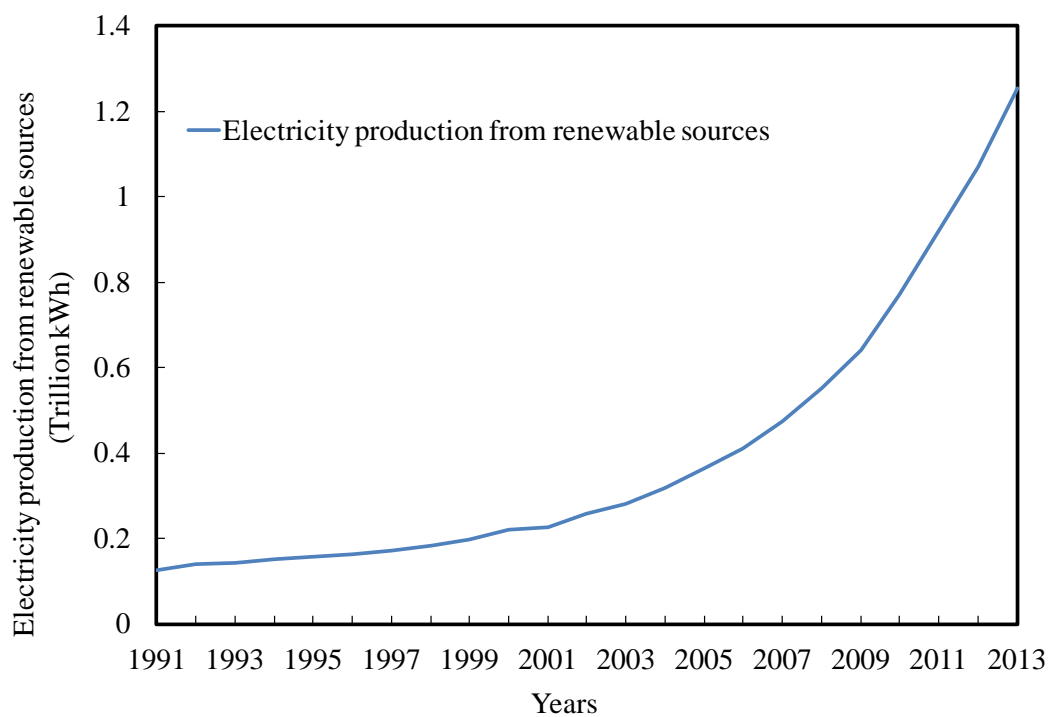

Figure 1-3 Electricity production from renewable sources, excluding hydroelectric  
(Source: World Bank 2014.)

## 1.2 Research Background and Significant

### 1.2.1 The relationship between environment and electricity

There has been a growing concern about global climate change mainly arising from energy-related carbon dioxide (CO<sub>2</sub>) emissions. To effectively reduce CO<sub>2</sub> emissions while keep economic growth, different countries have begun to search for new development paths.

As the main driver of social-economic activities, energy issues play the main role in the achievement of a low carbon society. Figure 1-4 shows the world primary energy consumption and CO<sub>2</sub> emissions from 1990 to 2014. As is anticipated, the energy consumption of world from 1990 to 2014 continues to grow. Among the total primary energy consumption, oil took a share of about 33%, followed by coal (27%), natural gas (21%), biomass and waste (10%), nuclear (6%), hydroelectric resources (2%) and other renewable energy (1%) (See Figure 1-5)

According to Figure 1-4, we can also know that the rapid development of socio-economy have resulted in not only enormous energy consumption, but also extensive emissions of CO<sub>2</sub>, both of them have put great press on the global environmental issues. If it is not solved in a good and efficient manner, not only will human society be beyond the goal of sustainable development, but it will also make a serious impact on the living environment and quality of human society.

As Figure 1-6 shown, the electricity and heat production accounted for the largest proportion of CO<sub>2</sub> emissions in 2014, reached at 42%. In addition, of the total energy consumed in America, about 39% is used to generate electricity. Therefore, electricity consumption is an important portion of a consumer's environmental footprint. The need for electricity consumption to be clean and safe has never been more obvious.

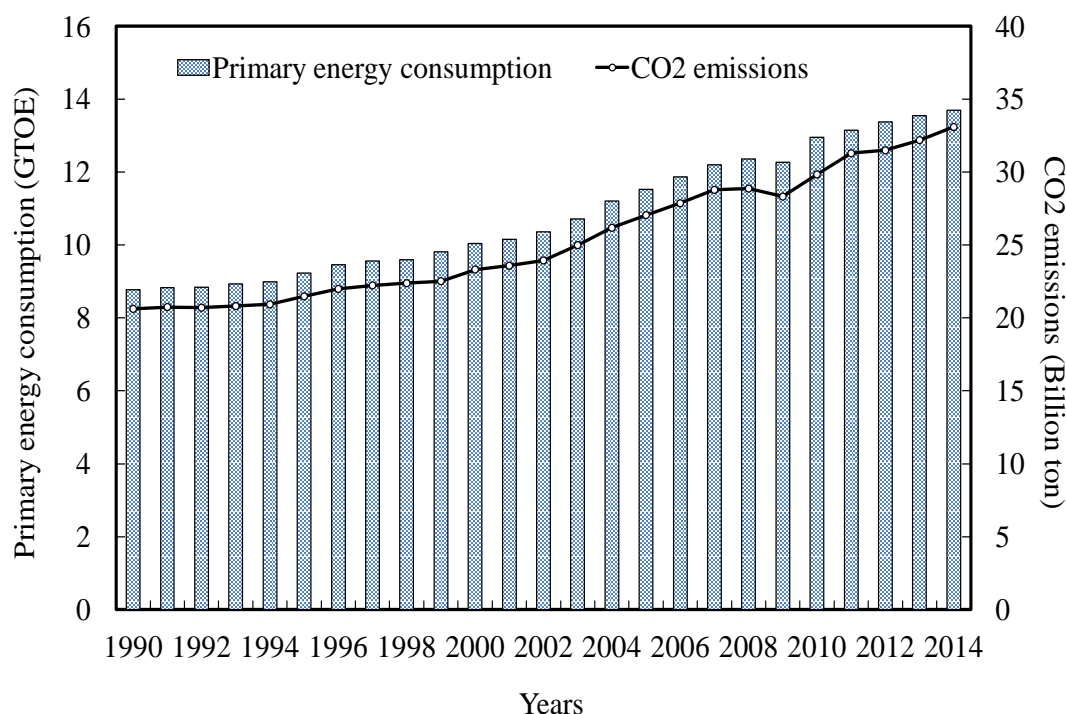

Figure 1-4 World primary energy consumption and CO2 emissions

(Source: World Energy Outlook 2015)

CHAPTER ONE: PREVIOUS STUDY AND PURPOSE OF THE STUDY

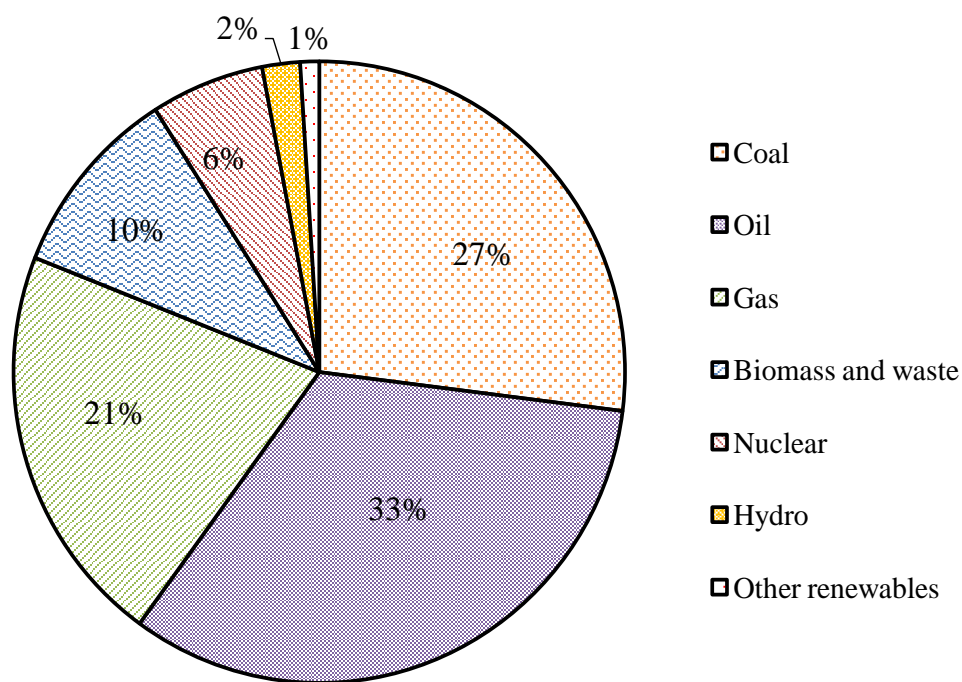

Figure 1-5 Share in primary energy supply in 2014

(Source: World Energy Outlook 2015)

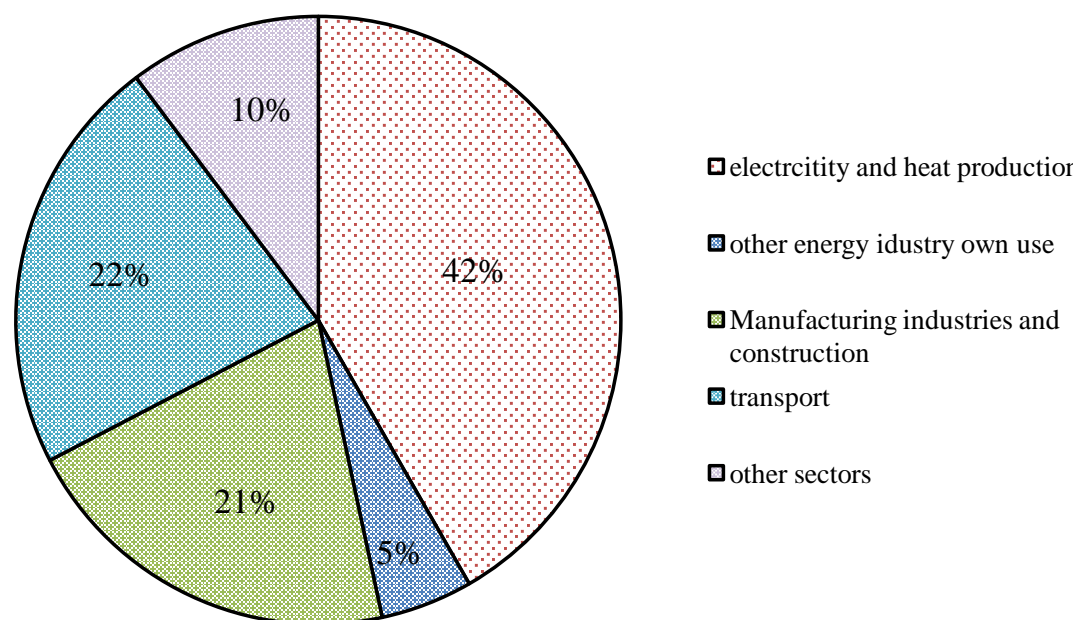

Figure 1-6 CO<sub>2</sub> emissions by sector in 2014

(Source: World Energy Outlook 2015)

### 1.2.2 The introduction of electricity market

In economic terms, electricity is a commodity capable of being bought, sold, and traded. An electricity market is a system that enabling purchases, through bids to buy; sales, through offers to sell; and short-term trades. Generally, it contains two important parts, wholesale electricity market and retail electricity market. A wholesale electricity market exists when competing generators offer their electricity output to retailers. The retailers then re-price the electricity and take it to market, and a retail electricity market exists when end-use customers can choose their supplier from competing electricity retailers.

One electricity market mainly contains four parts (Supply-side Resources, Load Serving Entities, End user customer and independent system operator (ISO) / regional transmission organization (RTO)). Supply-side resources provide the raw commodity for the whole market, that is, power energy, power energy which be issued by supply-side resources were sold through a variety of methods in the wholesale market. Supply-side resources provide power to market while it also remains some power ability to take as a spare part. Load Serving Entities buy the available power from the Supply-side on the wholesale market and sell the electricity to end users in retail market. It plays the role of middlemen in the whole electricity market and connects wholesale market and retail market. The end user is the consumers of entire market, in the retail market, load serving entities provide end users of electricity and transmission services.

The detailed components of the electricity supply chain are depicted in Figure 1-7. It is obvious that there are mainly three aspects in this energy supply chain, the energy commodity, the network services and the retail services. As for the part of energy commodity, power plants use different kinds of fossil fuels (coal, natural gas, and petroleum) and renewable sources (hydro and wind) to generate electricity. As for the part of network services, it concludes transmission and distribution lines. In this process, through transporting electricity over long distances and converting high voltage electricity to low voltage electricity, then, electricity can be transported to its final

### Power supply chain

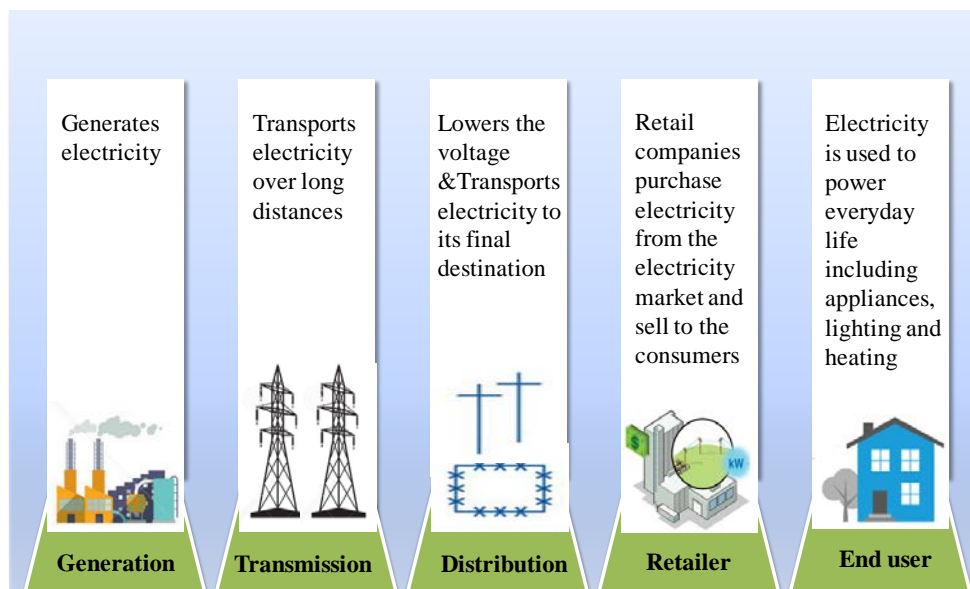

Figure 1-7 Components of the electricity supply chain



CHAPTER ONE: PREVIOUS STUDY AND PURPOSE OF THE STUDY

destination. As for the part of retail services, electricity retail companies purchase electricity from the electricity market and sell it to electricity consumers so that they can support their everyday life including appliances, lighting and heating, etc.

Electricity market which lifts prohibition has been divided into two parts, and these two parts linked by electricity suppliers, the market price signals from the generation side of the system has been delivered to the electricity side directly, the operation of the market will follow the price flow and power flow. As Figure 1-8 shown, First, on the generation side, ISO / RTO will organize a wholesale power market, according to some market-clearing rules, power suppliers and Load serving entities will bids the bilateral auction in that power market. Generally, there is a day-ahead and hour-ahead trading pattern. Through the auction, power suppliers and electricity suppliers obtain their power generating contracts and power purchase contracts separately. In the internal grid, ISO/RTO dispatch generation according to those two contracts, making the transaction successful completed. Meanwhile, in the retail market, based on pre-determined tariff scheme, as well as the whole electricity demand of end-uses, electricity suppliers deliver the electricity bought from wholesale to end users. In power transmission and distribution process, load serving entities take the responsibility. When electricity demand exceeds supply, LSE needs to purchase alternate services from supply side.

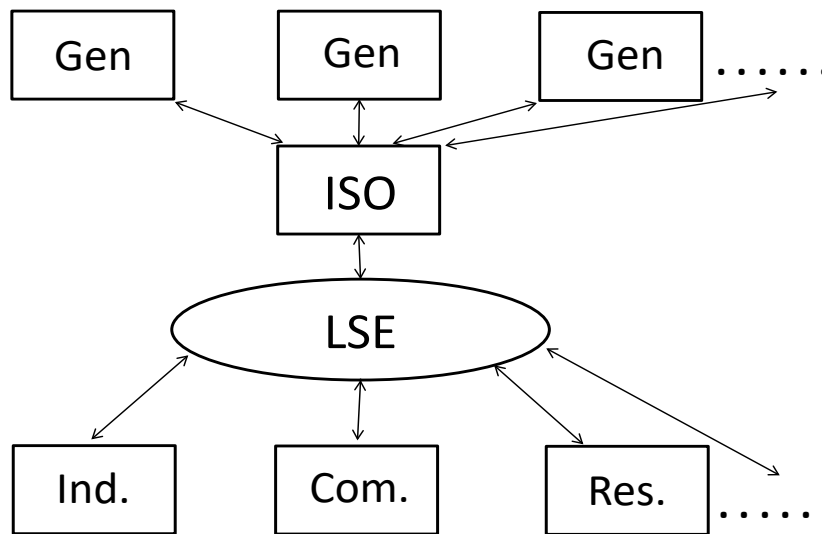

Figure 1-8 Schematic diagram of electricity market participants

### 1.2.3 The introduction of electricity price in different country

As the fulcrum of the electricity market, electricity price plays a very important role in this market in promoting market competition, improving the efficiency of power system operation and achieving optimal resource allocation. It is the most effective economic regulation lever in electricity market.

Electricity pricing (sometimes referred to as electricity tariff or the price of electricity) varies widely from country to country and it can even vary within a single region or distribution network of the same country. The price of power generation depends largely on the type and market price of the fuel used, government subsidies, government and industry regulation, and even local weather patterns.

The electricity price is the most important part of the reform of electric power industry, and magnifying the lever effect of the electricity price is propitious to the regulation of the inconsistency between electric providing and supplying, optimize the energy resource configuration and facilitating the foundational function of the electric industry in the economy domain of country.

Figure 1-9 is the average national electricity prices in US cents/kWh. We can see that Australia, Brazil and Philippines have expensive electricity price, on the contrary, India, Thailand and China have the cheapest electricity price.

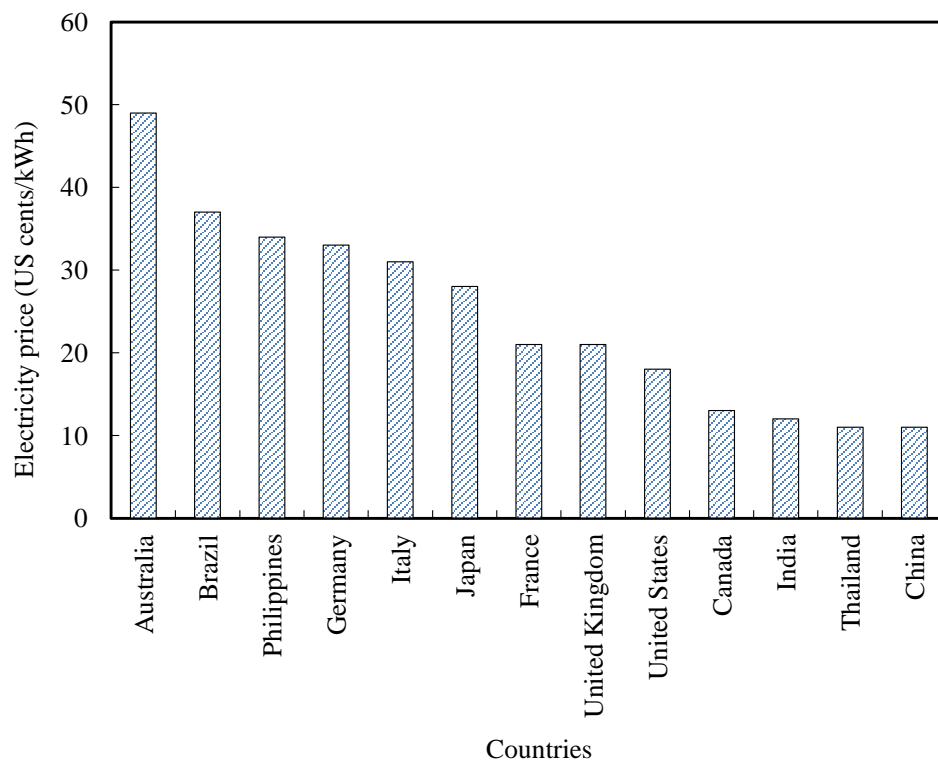

Figure 1-9 Average national electricity prices

(Source: Source: The Statistics Portal, 2016.)

## CHAPTER ONE: PREVIOUS STUDY AND PURPOSE OF THE STUDY

United States as one of the most developed country, its electricity market is complex and full of competition. As table.1-1 shows, electricity restructuring in the United States has its roots in the combination of the 1970s energy crises and the high costs involved in efforts to decouple the U.S. electric system from the world petroleum market [13]. From 1992, United States starts its modern restructuring process according to the first Energy Policy Act which allows non-utility generators and marketers take part in the competition of electricity market. Since 1996, in order to further stimulate the competition of electricity market and guide it to a healthy development direction, government issued Order 888 which aimed at encourage competition by removing barriers to access to the utility-owned electricity grid. Due to the characteristic difference, United States begin restructuring efforts by each individual states since 1998.

Based on the limitation of common conditions, there are also a variety of electricity price systems. The United States has the largest number and the widest range of electricity price projects. Table.1-2 shows the profiles of electricity in different states. We can know that different palace have different electricity retail price, it related to many items, such as weather, geography, etc.

Since TOU price began to appear in the 1960s, its popularity and implementation have varied in accordance with the degree of attention and encouragement of the government and regulatory organizations. The Federal Energy Office funded more than 16 TOU price demonstration projects from 1975 to 1981.

According to the FERC’s survey in 2006, there were 187 power supply companies providing TOU electricity price, among which 148 companies provided it to residential users. However, usually various power supply companies just offered it as an option, so the actual participating users were much less. According to statistics, in 2005, there are about 1.57 million residential users participated in the TOU price project, about 1.4% of the 120 million U.S. residential users. From the practical experience in the United States, the design of TOU electricity price projects is

Table 1-1 Main process of electricity restructuring in United States

Year	Issues
1970	Energy crises and high cost from the petroleum market
1992	Allow non-utility generators and marketers take part in the competition
1996	Stimulate competition by encourage utility-owned electricity grid
1998	Begin restructuring efforts by each individual states

Table 1-2 State Electricity Profiles

(Source: U.S. Energy Information Adiministration)

Name	Average retail price (cents/kWh)	Net summer capacity (MW)	Net generation (MWh)	Total retail sales (MWh)
California	13.01	67,328	204,125,596	258,525,414
Hawaii	25.12	2,536	10,836,036	10,016,509
Nebraska	7.52	7,857	36,630,006	29,849,460
New York	16.41	39,357	136,961,654	144,623,573
North Dakota	7.11	6,188	34,739,542	12,956,263
Oregon	7.56	14,261	55,126,999	46,025,945

## CHAPTER ONE: PREVIOUS STUDY AND PURPOSE OF THE STUDY

critical to their effectiveness. While designing, the following questions should be considered carefully: For the selection of period, it is only divided into peak and non-peak, or peak, ordinary and valley? Are weekends and holidays treated equally? Are seasonal price and TOU price combined together? Price margins between peak load and non-peak load have to reach a certain value to give signs to users and help them reduce electricity expenditure while power supply companies don't have income losses. At the same time, it is very important to take into account the users' needs, and allow them to easily compare and choose electricity prices.

The first American real-time price (RTP) project was a pilot project in the 1980s in California. Its purpose was to test the users' response and their acceptance of real-time price. Real-time price project is closely related to the progress of smart grid. Figure 1-10 shows the number of smart

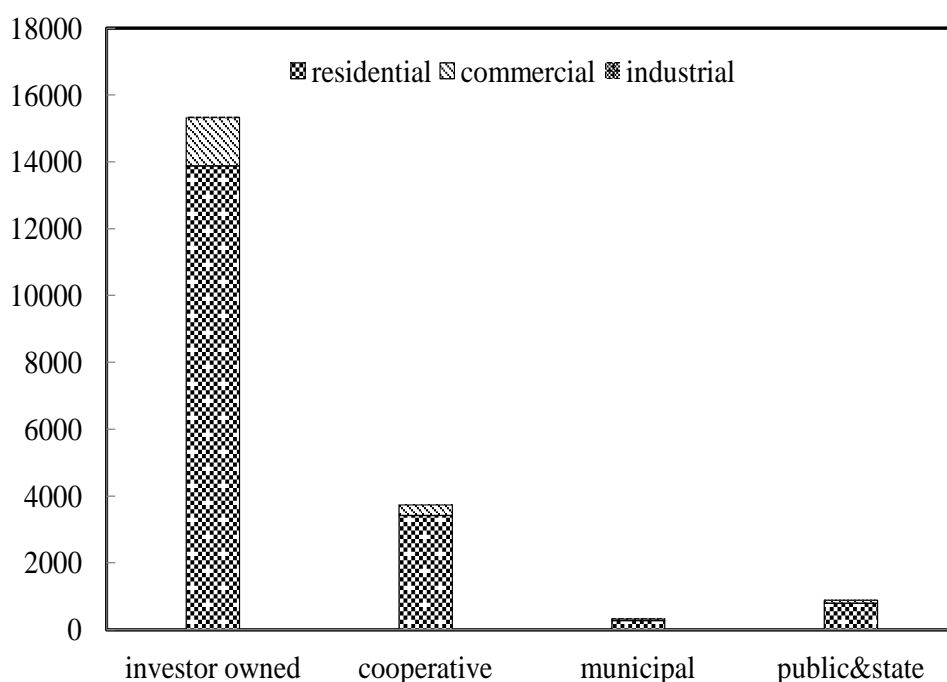

Figure 1-10 Number of AMI Installations by Customer Type (Thousand)

(Source: U.S. Energy Information Administration)

metering infrastructure in America. We can see that about 76% were installed by Investor Owned utilities and about 90% were residential customer installations. It makes the implement of RTP easier.

Major components of U.S. average electricity price illustrated in Figure 1-11. It can be seen that generation part represents a significant share of the total electricity price, it accounted for 65%, followed by distribution (25%) and transmission (9%). Fig 1-12 displayed the average electricity prices vary by type of customer. It is obvious that residential and commercial consumers hold the higher price than industrial consumers and transportation side. It is due to that residential and commercial consumers cost more to distribute electricity, such as voltage request. On the contrary, Industrial consumers use more electricity and can receive electricity without so many conditions, so it is more efficient and less expensive to supply electricity to these customers.

CHAPTER ONE: PREVIOUS STUDY AND PURPOSE OF THE STUDY

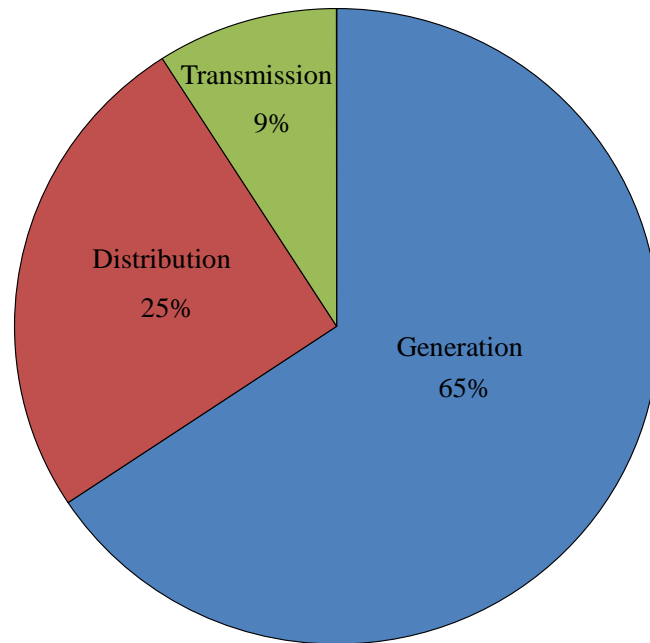

Figure 1-11 Major components of U.S. average electricity price, 2014  
(Source: U.S. Energy Information Administration, Annual Energy Outlook 2015)

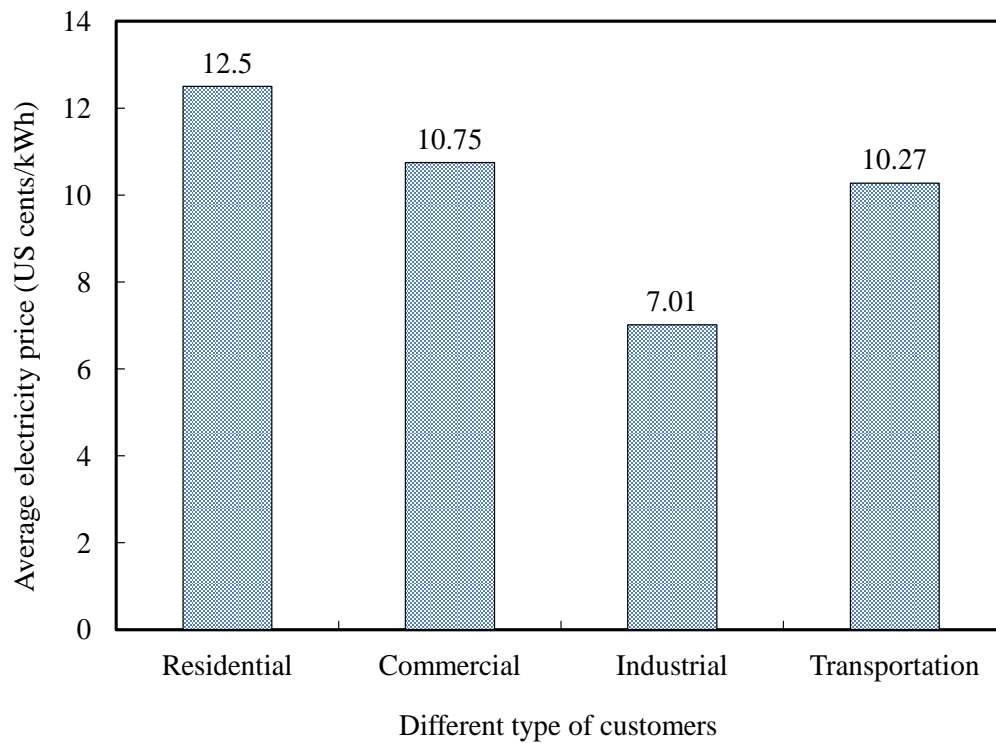

Figure 1-12 Average electricity prices vary by type of customer  
(Source: U.S. Energy Information Administration, Annual Energy Outlook 2015)

## CHAPTER ONE: PREVIOUS STUDY AND PURPOSE OF THE STUDY

Japan as one of the chief components of Organization for Economic Co-operation and Development (OECD) Asian countries, its electricity pricing system also worth us paying attention. As the world's second largest economic power, Japan has its own special electricity system.

Figure 1-13 is the Japan's electricity generation by fuel type. We can see that Japan's use of fossil-fuel generation—the combined amount of electricity generated from natural gas, oil, and coal—was up 21% in 2012, compared to the level in 2011 after the Tohoku earthquake and related tsunami that led to the destruction of Tokyo Electric Power Company's (TEPCO) Fukushima Daiichi nuclear power plant and subsequent outages at other plants. From 2002 to 2012, before that disaster, we can know that Japan almost counted on nuclear power for 30% of its electricity—the one of the highest proportions in the world.

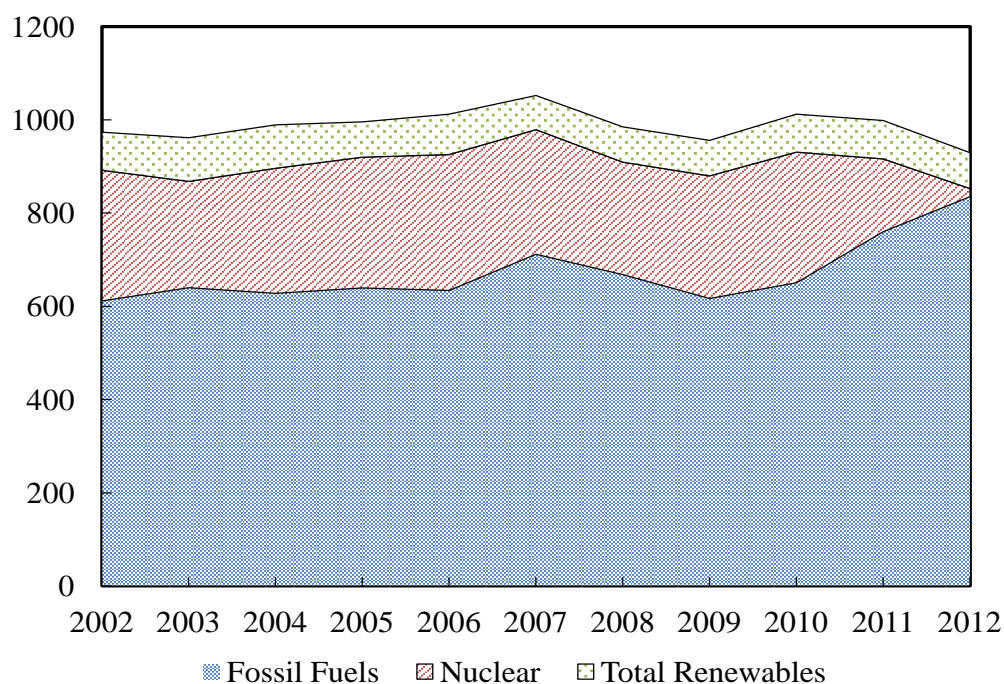

Figure 1-13 The Japan's electricity generation by fuel type (Billion Kilowatt-hours)

(Source: U.S. Energy Information Administration)

The electricity market of Japan is partially liberalized but still very low competition. There are mainly 10 electricity companies which dominate the market according to the location difference. The detailed information of those 10 electricity utilities was illustrated in Figure 1-14. After the end of World War II in 1945, Japanese government starts to restructure its electricity utility industry. Meanwhile, in order to democratize the economy, nine regional privately owned and managed Electricity Utilities were established in 1951. Since 1972, with the return of Okinawa to Japan, the number of Electricity Utilities in Japan reached to ten [14]. Table 1-3 shows the electricity company data which provided by Handbook of Electric Power Industry. It is obvious that Tokyo company and Kansai company hold almost the most heaviest proportion of the electricity supply business in Japan due to its population and economy situation.

CHAPTER ONE: PREVIOUS STUDY AND PURPOSE OF THE STUDY

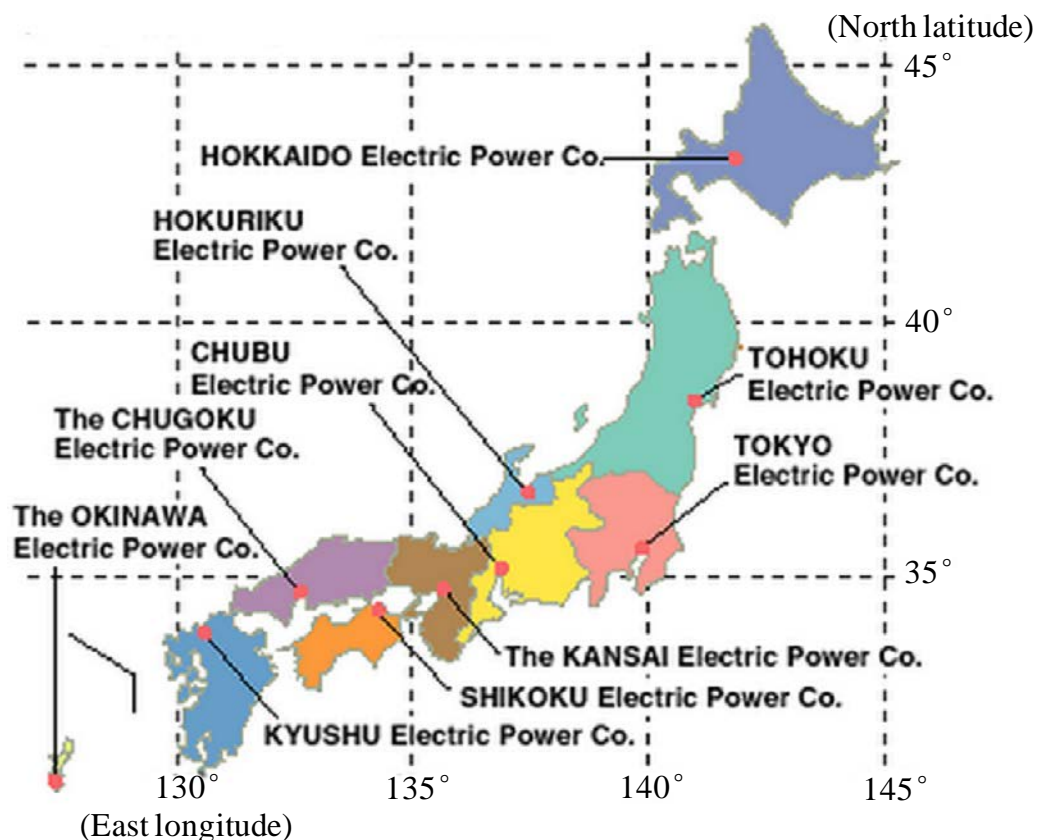

Figure 1-14 The ten electric power companies by main service area

(Source: Map of Japanese electricity grid)

Table 1-3 Detailed company data of 10 Japanese electricity utilities

(Source: Handbook of Electric Power Industry, Fiscal year ending March 31, 2015)

Company	Generating Capacity (MW)	Electricity Supplied (GWh)	Electricity Sales (GWh)	Number of Customers (Thousands)
Hokkaido	7,751	33,134	29,810	4,029
Tohoku	17,806	83,829	76,623	7,753
Tokyo	66,057	277,095	257,046	29,216
Chubu	34,058	134,515	124,075	10,647
Hokuriku	8,068	30,856	27,884	2,117
Kansai	37,442	145,854	134,490	13,637
Chugoku	11,995	63,111	57,868	5,271
Shikoku	6,967	28,974	26,392	2,862
Kyushu	20,135	87,783	81,279	8,712
Okinawa	2,136	8,460	7,531	891

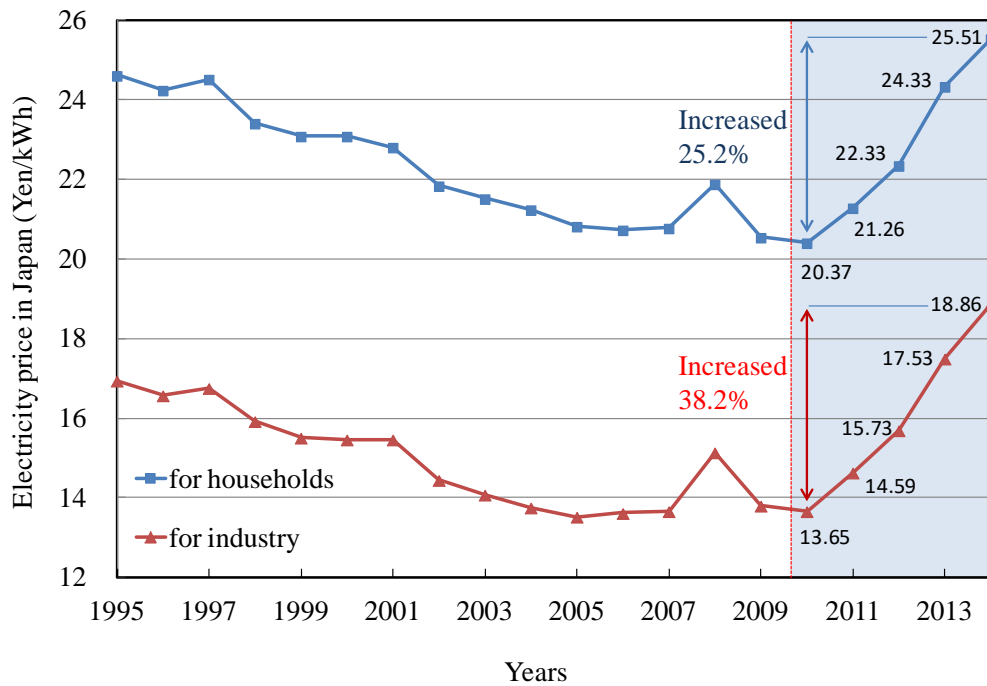

Figure 1-15 Electricity price in Japan

(Source: Japan’s Electricity Market Reform and Beyond, 2015.)

Figure 1-15 displayed the electricity price of households and industry in Japan from 1995 to 2014. It is clear that after the Great East Japan Earthquake that struck on March 11, 2011, end-use electricity prices are spiking now more than ever. Compared to 2010, electricity prices, in particular, have increased very sharply over recent years. In 2014, the annual average price of electricity in Japan reached a record-breaking level of 25.51 Yen/kWh for households, up from around 20.37 Yen/kWh in 2010. It is almost increased 25.2%. What’s more, even for industry consumers, the electricity price increased 38.2% as well. The reason of the electricity price increase trends may be concluded as follows.

Due to power shortage, a great number of power generation and supply equipments and lines should be increased to meet the seasonal peak consumption. But along with the seasonal changes, electricity load will reduces. Therefore, equipment utilization rate will drop significantly and the operation and maintenance costs will also increase. According to the cost-based principle, these costs must be reflected in the electricity price.

Figure 1-16 shows the general electricity tariff structure in Japan. There have many alternatives for consumers to choose. According to the characteristics of consumers’ electricity consumption, they can select the most suitable electricity price by themselves. In addition, the time-of use electricity price in Japan is the most complex one. For example, it has the seasonal price for high pressure and UHV users. The seasons were summer and other seasons. Electricity charges were based on different times in different seasons. And, in any season there was electricity peak and valley difference of day and night. So there was a peak-valley price mechanism of day and night.



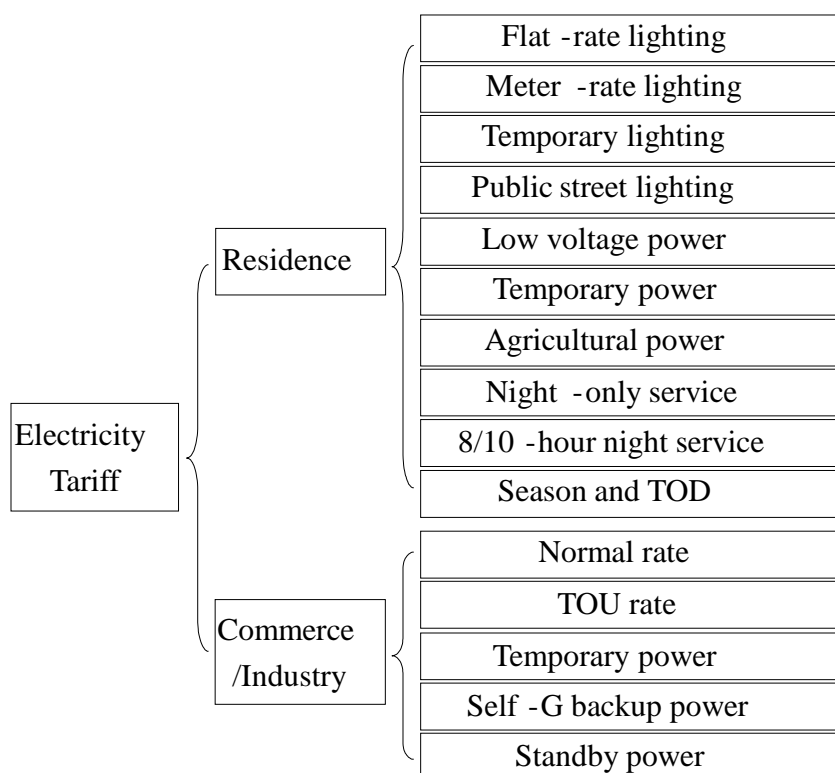

Figure 1-16 General electricity tariff structure in Japan

(Source: Kyushu electricity.)

At present, Japan is vigorously developing intelligent community cause. Dynamic pricing project based on smart grid is the research focus. Kitakyushu City Higashita area was the base of dynamic pricing research project. In 2012 a five-level electricity price system was introduced to ordinary families in this area. The price level changes in accordance with the power supply and demand. The applicable price level will be inferred to home through smart meters in the previous day and on the morning of the day. Every family can confirm the price through the pad terminal (indoor display) which is connected to the smart meters through wireless LAN. The detailed information of this project will be introduced in the following chapter. It is believed to play a positive role in the implementation of real-time price in Japan.

In addition to United States and Japan, China which represents emerging countries also plays an important role during the transformation of traditional world electricity market.

The development of China's electricity pricing can be roughly divided into three stages: power load management stage, TOU price adjustment stage and real-time price release stage.

In the early 1980s, China Electric Power Research Institute first proposed the concept of electricity load management, which was the prototype of the intelligent power consumption ideological. At that time, China was suffering serious domestic power shortage. When a user's electricity consumption surpassed the fixed amount, power load management system would use sound, light and other alarm means to alert the user to take the initiative to reduce the load. If the alarm was not valid, a remote control would be chosen to enforce the reduction of load. Therefore, electricity load management system changed the management philosophy of Chinese traditional electricity consumption, and emphasized the active participation of power users.

## CHAPTER ONE: PREVIOUS STUDY AND PURPOSE OF THE STUDY

After the national-wide power shortage in 2003, many provinces and cities have strengthened the demand side management, and have introduced the TOU price and wet-and-dry price system. The implementation of TOU pricing policy plays an important role in peak load shifting and demand shaping as well as in increasing the load rate, adjusting the power consumption structure, reducing the waste of water and other energy and improving water utilization efficiency. However, compared with the United States and other developed countries, there are many defects in China's price policy. First, the implementation range of TOU price is not wide enough. It is mainly for big industrial users as well as non-industrial users and commercial users whose electricity capacity is of 100kVA or above. With the development of society and the improvement of people's living standard, residential electricity consumption has gradually become one of the main factors of peak load. But because only a handful of provincial power grids have implemented residential TOU electricity price system, therefore TOU electricity price hasn't reflected its superiority. Second, China's TOU electricity price spread amplitude is small, and the peak extinction effect is completely not reached. China's TOU electricity price is based on two-part electricity price. Because the basic charge is the same and the TOU price and seasonal price are only implemented according to degrees, these two kinds of electricity charges can't widen the gap. Users have to pay a price for transferring the power consumption from peak time to valley time, so if the electricity charge margin can't supplement their losses, they will not make the transfer. As a result, TOU price will have no meaning at all. Third, China's TOU electricity price lacks flexibility. Once it is fixed, the price for each period will remain unchanged. So it cannot accurately reflect the changes of the load of each period during a day or the cost of power supply. At the same time, because the present TOU electricity price is based on a non-perfect two-part electricity price system, and a timeshare preference is only implemented according to degrees but not combined with the market, it doesn't fully reflect the leverage of dynamic electricity price.

For real-time price, due to the lack of technical support, appropriate intelligent meters and the imperfection of China's smart grid, residential electricity consumption information cannot be quickly and accurately collected. So this stage is still in preparatory stage

### 1.3 Review of Previous Studies

With the incessant development of the world economy and the improvement of people's living standards, the power grid's operating system has stepped into a new historical stage. In order to cater to the change, new electricity price system need to help grid utility to meet consumers' electricity demand, meanwhile, help saving the energy resources. Under this background, dynamic pricing appeared. In recent years, dynamic pricing and its related learning become a hot research topic that has received a considerable amount of attention. Meanwhile, the literature on dynamic pricing also has grown very fast, with contributions from different scientific communities: operations research and management science, marketing, computer science, and economics. This research briefly reviews the dynamic pricing from two important parts, dynamic pricing system and the implementation of dynamic pricing in buildings.

#### 1.3.1 Study on dynamic pricing system

Dynamic pricing system can be regarded as the combined application of three research fields: demand response side, dynamic pricing estimation, and Economic evaluation.

As for the demand side, three branches were considered by researchers. Jonas Katz develops simple pricing schemes, though economically less efficient, dynamic pricing could become important in an early phase to initialize the development of household demand response. This reveals variable price which can cause load shift incentives. P. Fari and Z. Vale concentrate on the discussion of demand response simulation. They present DemSi (a demand response simulator that allows studying demand response actions and schemes in distribution networks), combining with realistic network simulation based on PSCAD, obtains the expected load reduction. David P also worked a lot for the demand response simulation. He develops and assesses the performance of a short-term demand response (DR) model for utility load control with applications to resource planning and control design. Dynamic demand for various consumers and the investigation of pilot experiment are the other indispensable parts related to demand side research. Ming-Feng Hung estimates the dynamic demand for residential electricity in Taiwan, find a significant seasonal difference in the electricity demand. Koen Vanthournout presents the experimental demand response pilot results, based on day-ahead dynamic price. Dongsik Jang introduces Korean critical peak pricing pilot and concludes that the pilot experiment achieved a considerable peak load reduction. Karen Herter summarizes the results from an exploratory analysis of residential customer response to a critical peak pricing (CPP) experiment in California, gives us important reference to the following study of dynamic pricing system.

As for the dynamic pricing estimation side, there are also three essential parts, dynamic price optimization, dynamic price model and dynamic price policy and property. Ehsan Dehnavi makes a contribution to dynamic price optimization. Author presents a new procedure for the optimal pricing in TOU and investigates the effects of DEDTOU on the reliability improvement and cost reduction. Yong Wang develops a model and compares both CPP and TOU rates in order to gain more accurate knowledge regarding annual electric costs and GHG emissions. With those results, manufacturing enterprises will be able to make more informed decisions on which service to choose and how to use electricity while fulfilling their role for sustainability by enrolling. Nina L and Yong Wang display the research about dynamic price policy and property. Nina L consults residential electricity consumers in three Australian states on their perceptions and acceptance of various cost-reflective pricing scenarios and associated technologies to support such pricing (smart meters, in-home displays and direct load control devices). Yong Wang surveys 43 TOU

## CHAPTER ONE: PREVIOUS STUDY AND PURPOSE OF THE STUDY

programs offered by U.S. utilities targeting industrial customers, meanwhile, implications for customers, utilities, and regulatory agencies are discussed.

As for the economic evaluation side, there is still the huge amount of literature on this subject. Javier Campillo analyzes electricity usage for 400 residential customers in Sollentuna, Sweden and calculates the electricity costs of 400 users for two different pricing schemes. Drawn the conclusion that real time electricity (RTP) pricing offered lower costs for most users and RTP customers perceived lower costs even without adopting demand response strategies.

### **1.3.2 Study on the implement of dynamic pricing in buildings**

In addition to the study of dynamic pricing system, the implement of dynamic pricing in buildings is also an extremely hot research topic. A majority of researchers concentrate on technique discussion on the method how buildings could better respond to the dynamic pricing. As for this section, we essentially sketch important references from two parts: load reduction and load shifting techniques and load control techniques. Melek Yalcintas investigates potential cost conservation measures that focus on reducing energy at times of higher energy costs to maximize energy savings, conclude that alternative scheduling and thermal energy storage can reduce monthly electricity rates. Yuehong Lu develops optimal scheduling strategy for building energy systems. As far as we know, the energy systems often have strong non-linear characteristics and have discrete working ranges. The author used the mixed-integer nonlinear programming approach to solve the optimal scheduling problems of energy systems in building which integrated with energy generation and thermal energy storage. Haider Tarish Haider proposes a dynamic residential load scheduling system for optimal scheduling of household appliances on the basis of an adaptive consumption level pricing scheme. The proposed load scheduling system encourages customers to manage their energy consumption within the allowable consumption allowance of the proposed dynamic pricing scheme to achieve lower energy bills. Mesut Avcı proposes a practical cost and energy efficient model predictive control (MPC) strategy for HVAC load control under dynamic real-time electricity pricing.

### 1.4 Purpose of this study

The issues of energy consumption and environmental pollution have become more and more serious since the 21st century. In addition, large amount of shutdowns of nuclear power plants have raised concerns about electric power supply shortages in Japan. The innovation of electric power system is the most pressing priority. In terms of the electric power system, electricity pricing mechanism may be the most important option to secure the energy system. Under this background, electricity dynamic pricing appeared as a means of controlling electricity demand and alleviating the tight demand-supply balance. Electricity dynamic pricing increases electricity prices to punitive levels at peak hours on critical days announced beforehand. It is a kind of pricing method which could reflect marginal cost of generating electricity. The review of the existing studies can suggest the tendency of dynamic pricing development. These researches always focused on the performance of dynamic pricing and how to realize more effective pricing system. What's more, most literatures just explore the implement of dynamic pricing in buildings from load scheduling system and load control system.

In this study, according to the smart meter dataset of about 200 households and 50 offices that took part in demonstration project in Kitakyushu, Japan, the research intends to evaluate the effects of electricity dynamic pricing implementation according to its most stated objective: electricity load reduction of peak demand periods. In response to electricity dynamic pricing strategies, people may change their patterns of electricity usage. However, some kinds of consumers may do not want to change their living habits or they must use electricity in peak hours which has higher electricity price owing to the extremely high temperature and the working characteristics. Therefore, the integrated assessment of application of electricity dynamic pricing in buildings is necessary. This research not only analyze the effects of electricity dynamic pricing on the cost performance of buildings in present scenario and tiny demand response scenario, but also gives an integrated analysis and evaluation of electricity dynamic pricing in buildings with different energy saving technologies.

Figure 1-17 is the research flow.

#### ◇ Previous study

In chapter one, current energy and environmental situations, as well as the electricity market and main electricity pricing system in different countries are presented. Based on the background, the purpose of current research is proposed.

#### ◇ Theoretical survey

In chapter two, the development status and challenges of smart grids and dynamic pricing in main driver countries have been surveyed. It compares the development backgrounds and infrastructure status of various countries and presents an overview of the smart grid and dynamic pricing development situations in some main driver countries. Moreover, discusses the research results produced by smart grid and dynamic pricing projects in these countries, summarizes their achievements and challenges,

#### ◇ Investigation

Chapter three investigates the situation of Japanese dynamic pricing model in residential house, meanwhile, summarizes the results from an exploratory analysis of about 200 households that took part in dynamic price experiment in Kitakyushu, Japan. Using hourly load data collected from smart meter, tries to find statistically load reduction for participants during the DP time block. In

## CHAPTER ONE: PREVIOUS STUDY AND PURPOSE OF THE STUDY

addition, this chapter also discussed the effect of dynamic pricing which influenced by temperature and the awareness of consumers.

Chapter four investigates the situation of Japanese dynamic pricing model in office building. Moreover, it explores the energy consumption of each target building. Meanwhile, using hourly load data collected from smart meter and baseline calculating method, it estimates the effect of dynamic pricing system on the energy saving of office, concludes the load reduction for participants during the DP time block. In addition, this paper also discusses the situation of demand response of office customers according to the related questionnaire made by Kitakyushu city, presents that giving consideration to both energy saving and economic benefit is an essential way to heighten the effective utilization of DP in office building.

This section contributes to the implementation of dynamic pricing and provides a good experience and reference to other countries.

### ✧ Evaluation Method

In chapter five, the overview of evaluation method for electricity dynamic pricing and energy saving technology are introduced which provide a reference for government and power companies to successfully process the following development of electricity dynamic pricing. What's more, the evaluation systems for the utilization of electricity dynamic pricing and energy saving technology (take the distributed energy system as the representative) have been illustrated in detail. Meanwhile, the main assessment criteria (namely, cost saving ratio, primary energy saving ratio, as well as CO<sub>2</sub> emissions reduction ratio) have been introduced to estimate the overall performance of introducing energy saving technologies into the different buildings.

### ✧ Numerical analysis

In chapter six, the effects of dynamic pricing on the cost performance of buildings in present scenario and demand response scenario have been presented. In detail, four kinds of buildings which located in Yahata area have been selected as the target research buildings, including residential house, hospital, office and hotel. As for demand response scenario, according to the information of electricity load and electricity tariff, the evaluation process starts with setting specific electricity saving actions for four kinds of buildings which is then followed by the calculation of total year electricity cost.

In chapter seven, it introduced some related energy saving technologies including storage battery, photovoltaic and distributed energy system. Meanwhile, this chapter gives an analysis and evaluation of electricity dynamic pricing in different buildings which equipped with different energy saving technologies under the condition that if consumers do not well respond to DP as anticipated. The primary energy saving effect and environmental impact of each energy saving technology has also been discussed.

### ✧ Conclusion

In chapter eight, a conclusion of whole thesis is deduced.

**CHAPTER ONE: PREVIOUS STUDY AND PURPOSE OF THE STUDY**

<b>PREVIOUS STUDY</b>	<div style="border: 1px dashed black; padding: 5px;"> <p><b>CHAPTER ONE</b> Previous Study and Purpose of the Study</p> </div>		
<b>THEORETICAL SURVEY</b>	<div style="border: 1px dashed black; padding: 5px;"> <p><b>CHAPTER TWO</b> Survey on the Development Status and Challenges of Smart Grids and Dynamic Pricing in Main Driver Countries</p> </div>		
<b>INVESTIGATION</b>	<table border="1" style="width: 100%; border-collapse: collapse;"> <tr> <td align="center" style="width: 50%; padding: 5px;"> <div style="border: 1px dashed black; padding: 2px;"> <p><b>CHAPTER THREE</b> Exploratory Analysis of Kitakyushu Residents Response to Dynamic Electricity Pricing</p> </div> </td> <td align="center" style="width: 50%; padding: 5px;"> <div style="border: 1px dashed black; padding: 2px;"> <p><b>CHAPTER FOUR</b> Exploratory Analysis of Kitakyushu Offices Response to Dynamic Electricity Pricing</p> </div> </td> </tr> </table>	<div style="border: 1px dashed black; padding: 2px;"> <p><b>CHAPTER THREE</b> Exploratory Analysis of Kitakyushu Residents Response to Dynamic Electricity Pricing</p> </div>	<div style="border: 1px dashed black; padding: 2px;"> <p><b>CHAPTER FOUR</b> Exploratory Analysis of Kitakyushu Offices Response to Dynamic Electricity Pricing</p> </div>
<div style="border: 1px dashed black; padding: 2px;"> <p><b>CHAPTER THREE</b> Exploratory Analysis of Kitakyushu Residents Response to Dynamic Electricity Pricing</p> </div>	<div style="border: 1px dashed black; padding: 2px;"> <p><b>CHAPTER FOUR</b> Exploratory Analysis of Kitakyushu Offices Response to Dynamic Electricity Pricing</p> </div>		
<b>EVALUATION METHOD</b>	<div style="border: 1px dashed black; padding: 5px;"> <p><b>CHAPTER FIVE</b> Evaluation Methods for Electricity Dynamic Pricing System and Energy Saving Technologies</p> </div>		
<b>NUMERICAL ANALYSIS</b>	<table border="1" style="width: 100%; border-collapse: collapse;"> <tr> <td align="center" style="padding: 5px;"> <div style="border: 1px dashed black; padding: 2px;"> <p><b>CHAPTER SIX</b> Analysis of the Effects of Electricity Dynamic Pricing on the Cost Performance of Buildings in Present Scenario and Demand Response Scenario</p> </div> </td> </tr> <tr> <td align="center" style="padding: 5px;"> <div style="border: 1px dashed black; padding: 2px;"> <p><b>CHAPTER SEVEN</b> Analysis and Evaluation of Electricity Dynamic Pricing in Buildings with Different Energy Saving Technologies</p> </div> </td> </tr> </table>	<div style="border: 1px dashed black; padding: 2px;"> <p><b>CHAPTER SIX</b> Analysis of the Effects of Electricity Dynamic Pricing on the Cost Performance of Buildings in Present Scenario and Demand Response Scenario</p> </div>	<div style="border: 1px dashed black; padding: 2px;"> <p><b>CHAPTER SEVEN</b> Analysis and Evaluation of Electricity Dynamic Pricing in Buildings with Different Energy Saving Technologies</p> </div>
<div style="border: 1px dashed black; padding: 2px;"> <p><b>CHAPTER SIX</b> Analysis of the Effects of Electricity Dynamic Pricing on the Cost Performance of Buildings in Present Scenario and Demand Response Scenario</p> </div>			
<div style="border: 1px dashed black; padding: 2px;"> <p><b>CHAPTER SEVEN</b> Analysis and Evaluation of Electricity Dynamic Pricing in Buildings with Different Energy Saving Technologies</p> </div>			
<b>CONCLUSION</b>	<div style="border: 1px dashed black; padding: 5px;"> <p><b>CHAPTER EIGHT</b> Conclusions and Prospect</p> </div>		

Figure 1-17 Research Flow

## CHAPTER ONE: PREVIOUS STUDY AND PURPOSE OF THE STUDY

### REFERENCE

- [1] Zeng Ming, Xue Song, Ma Mingjuan, Zhu Xiaoli. New energy bases and sustainable development in China: A review. *Renewable and Sustainable Energy Reviews* 2013; Volume 20, April 2013, Pages 169–185
- [2] Sunday Olayinka Oyedepo. On energy for sustainable development in Nigeria. *Renewable and Sustainable Energy Reviews*. Volume 16, Issue 5, June 2012, Pages 2583–2598
- [3] Donald Huisingh, Zhihua Zhang, John C. Moore, Qi Qiao, Qi Li. Recent advances in carbon emissions reduction: policies, technologies, monitoring, assessment and modeling. *Journal of Cleaner Production*. Volume 103, 15 September 2015, Pages 1–12
- [4] Hu Xuehao. Smart grid: a development trend of future power grid. *Power System Technology*, 2009, 33(14): 1-5
- [5] Ettore Bompard, Tao Huang, Yingjun Wu, Mihai Cremenescu. Classification and trend analysis of threats origins to the security of power systems. *International Journal of Electrical Power & Energy Systems*. Volume 50, September 2013, Pages 50–64
- [6] Minghong Peng, Lian Liu, Chuanwen Jiang. A review on the economic dispatch and risk management of the large-scale plug-in electric vehicles (PHEVs)-penetrated power systems. Volume 16, Issue 3, April 2012, Pages 1508–1515
- [7] Paul L. Joskow, Dynamic pricing of electricity
- [8] Goutam Dutta, Krishnendranath Mitra. *Dynamic Pricing of Electricity: A Survey of Related Research*. August 2015.
- [9] Kueck JD, Kirby BJ, Eto J, Staunton RH, Marnay C, Martinez CA, et al. Load as a reliability resource in restructured electricity markets, LBNL-47983. Berkeley, CA: Lawrence Berkeley National Laboratory; 2001.
- [10] Hirst E. The financial and physical insurance benefits of pricerresponsive demand. *Electr J* 2002;15(4):66–73.
- [11] Borenstein S. The trouble with electricity markets: understanding California’s restructuring disaster. *J Econ Perspect* 2002;16(1): 191–211.
- [12] Hirst E, Hadley S. Maintaining generation adequacy in a restructuring US electricity industry, ORNL/CON-472. Oak Ridge, TN: Oak Ridge National Laboratory; 1999.
- [13] Seth Blumsack, Lester B. Lave, Jay Apt. *Electricity Prices and Costs Under Regulation and Restructuring*. Industry Studies, Annual Conference, 2008.
- [14] *Electricity Review Japan*, The Federation of Electric Power Companies of Japan, 2016.
- [15] A.V. den Boer. *Dynamic pricing and learning: Historical Origins, Current Research, and New Directions*. University of Twente, October 23, 2013.
- [16] Jonas Katz, , Frits Møller Andersen, Poul Erik Morthorst. Load-shift incentives for household demand response: Evaluation of hourly dynamic pricing and rebate schemes in a wind-based electricity system. *Energy*, 2 August 2016.
- [17] P. Faria, Z. Vale. Demand response in electrical energy supply: An optimal real time pricing approach. *Energy*, Volume 36, Issue 8, August 2011, Pages 5374–5384.
- [18] David P. Chassina, b, Daniel Rondeau. Aggregate modeling of fast-acting demand response and control under real-time pricing. *Applied Energy*, Volume 181, 1 November 2016.
- [19] Ming-Feng Hung, Tai-Hsin Huangb, Dynamic demand for residential electricity in Taiwan under seasonality and increasing-block pricing. *Energy Economics*, Volume 48, March 2015, Pages 168–177.
- [20] Koen Vanthournout, Benjamin Dupont, Wim Foubert, Catherine Stuckens, Sven Claessens. An automated residential demand response pilot experiment, based on day-ahead dynamic pricing. *Applied Energy*. Volume 155, 1 October 2015, Pages 195–203.
- [21] Dongsik Jang, Jiyong Eom, Moon Gyu Kim, Ja Jeung Rho. Demand responses of Korean commercial and industrial businesses to critical peak pricing of electricity. *Journal of Cleaner Production*. Volume 90, 1 March 2015, Pages 275–290.
- [22] Karen Herter, Patrick McAuliffe, Arthur Rosenfeld. An exploratory analysis of California residential customer response to critical peak pricing of electricity. *Energy*. Volume 32, Issue 1, January 2007, Pages 25–34.



## CHAPTER ONE: PREVIOUS STUDY AND PURPOSE OF THE STUDY

- [23] Ehsan Dehnavi , Hamdi Abdi. Optimal pricing in time of use demand response by integrating with dynamic economic dispatch problem. *Energy*. Volume 109, 15 August 2016, Pages 1086–1094.
- [24] Yong Wang, Lin Li, Critical peak electricity pricing for sustainable manufacturing: Modeling and case studies. *Applied Energy*. Volume 175, 1 August 2016, Pages 40–53.
- [25] Nina L. Halla, Talia D. Jeannereta, Alan Raib. Cost-reflective electricity pricing: Consumer preferences and perceptions. *Energy Policy*. Volume 95, August 2016, Pages 62–72.
- [26] Yong Wang , Lin Li, Time-of-use electricity pricing for industrial customers: A survey of U.S. utilities. *Applied Energy*. Volume 149, 1 July 2015, Pages 89–103.
- [27] Javier Campillo, , Erik Dahlquist, Fredrik Wallin, Iana Vassileva. Is real-time electricity pricing suitable for residential users without demand-side management?. *Energy*. Volume 109, 15 August 2016, Pages 310–325.
- [28] Melek Yalcintas, William T. Hagen, Abidin Kaya. “An analysis of load reduction and load shifting techniques in commercial and industrial buildings under dynamic electricity pricing schedules.” *Energy and Buildings*. Volume 88, 1 February 2015, Pages 15–24.
- [29] Yuehong Lu, Shengwei Wang, Yongjun Sun, Chengchu Yan. Optimal scheduling of buildings with energy generation and thermal energy storage under dynamic electricity pricing using mixed-integer nonlinear programming. *Applied Energy*. Volume 147, 1 June 2015, Pages 49–58.
- [30] Haider Tarish Haider, Ong Hang See, Wilfried Elmenreich. Dynamic residential load scheduling based on adaptive consumption level pricing scheme. *Electric Power Systems Research*. Volume 133, April 2016, Pages 27–35.
- [31] Mesut Avci, Murat Erkoç, Amir Rahmani, Shihab Asfour, Model predictive HVAC load control in buildings using real-time electricity pricing. *Energy and Buildings*. Volume 60, May 2013, Pages 199–209.



**CHAPTER TWO: SURVEY ON THE DEVELOPMENT STATUS AND  
CHALLENGES OF SMART GRIDS AND DYNAMIC PRICING  
IN MAIN DRIVER COUNTRIES**

2.1 Introduction

2.2 Survey on the Development Status and Challenges of Smart Grids

2.2.1 Basic information of Smart Grids

2.2.2 Development background and infrastructure of Smart Grids

2.2.3 Development status and achievements of Smart Grids

2.3 Survey on the Development Status and Challenges of Dynamic Pricing

2.3.1 Basic information of dynamic price

2.3.2 Main method of demand response and electricity dynamic pricing

2.3.3 Development status and achievements of dynamic price

2.4 Barriers and Challenges of Smart Grids and Dynamic Pricing

2.5 Summary



## CHAPTER TWO: SURVEY ON THE DEVELOPMENT STATUS AND CHALLENGES OF SMART GRIDS AND DYNAMIC PRICING IN MAIN DRIVER COUNTRIES

### 2.1 Introduction

Smart grids represent one of the most significant evolutionary changes in energy management systems as they enable the integrated application which include decentralized energy systems, the use of large-scale renewable energy as well as major improvements in demand-side-management. The research about the development of smart grid has been carried out world widely for more than ten years and there are already successful cases and rich experiences in this field. In addition, as the increasing electrification in the modern society, it boosts the demand of electricity, especially during peak hours. In order to alleviate this kind of stress of utility grid, electricity dynamic pricing are designed and help to reduce the peak load or shift part of the peak load to some other off-peak time blocks by providing price signals to motivate customers to change their electricity consumption. In recent years, the research of the electricity dynamic pricing utilization and the related dynamic pricing programs has also received a considerable attention in the world. Both smart grid and electricity dynamic pricing have revealed the reformation of the modern power network.

The improvement and performance of the new power network continues what network operators have been doing for several decades, each region with its own approach and focus. Figure 2-1 concludes the main drivers in smart grid and dynamic pricing development. Here, we select one or two typical objects from each drive sector as representatives to investigate the development status of those two important components. United States and European Union are the chief component of OECD countries, Japan was selected from OECD Asian countries and China represents for the Emerging countries. In the following, we only take the smart grid as representative to introduce its footprint of each drive sector due to that electricity dynamic pricing is an essential derivation of smart grid to a certain extent. Since 2009, United States, European Union, Japan and China have developed their own smart grid roadmaps and have started research and demonstration projects in accordance with their own situations and requirements. In the United States, smart grids emphasize the reliability, safety and operational efficiency of power systems through the strong support of digital and other advanced technologies. In addition, the United States is also devoted to the reduction of power supply costs under the background of an aging power infrastructure. Europe's innovative smart grid scheme attempts to reconcile two approaches of renewable energy development, namely, large-scale centralized approaches and small-scale, local and decentralized approaches, to realize a transition toward a fully low-carbon electricity system while attempting to realize energy trading between European countries. To promote such types of objectives, the European Commission also monitored smart grid projects, proposed guidelines for the cost-benefit analysis of smart grid projects and smart meter deployment, investigated the complexity features of smart energy grids, and evaluated the social dimensions of smart grid projects. In Japan, because its energy self-sufficiency is a mere 4%, the focus of smart grid plans is to build renewable-friendly power grids. Moreover, the Great East Japan Earthquake that struck on March 11, 2011, and the subsequent nuclear power plant accident have prompted the Japanese government to adopt reforms targeted at the power system; here, smart grids provide stable power supplies and optimize overall grid operations from power generation to the end user. Moreover, Japan has developed smart grids toward achieving CO<sub>2</sub> emission reductions, as stipulated in the Kyoto Protocol. In China, high electricity consumption and multiple electricity load structures have appeared with the rapid development of the economy

**CHAPTER TWO: SURVEY ON THE DEVELOPMENT STATUS AND CHALLENGES OF  
SMART GRIDS AND DYNAMIC PRICING  
IN MAIN DRIVER COUNTRIES**

and increasingly large populations, which result in a high demand for a Strong smart grid. China prefers to renovate traditional power systems with modern information technology while establishing a highly automated and widely distributed network for energy exchange in an attempt to solve its energy balance problem.

Following a series of attempts and explorations, smart grid development has entered a critical period. Most research and demonstration projects in the United States and Europe have been completed with the support of government funds. These pioneers should sum up the mature technologies, present a reasonable market mechanism and business model, establish a generally approved standards system so that these activities can attract investments in smart grids and encourage common users to actively participate in the subsequent construction of smart grids, and remove the barriers to the widespread use of smart grids. By the end of 2015, Japan has also finished four domestic demonstration projects located in Keihanna Science City, Yokohama City, Kitakyushu City and Toyota City as planned. The experience of their utilization of renewable energy and energy management system as well as other advanced technologies is worthy of a detailed summary. Even in China, a large number of research and demonstration projects have been deployed on schedule, and some mature technologies have already entered the extension phase. Consequently, the exchange and cooperation between countries becomes very important at such a crucial time. Sharing lessons learned, strengthening technical cooperation, and formulating international standards together toward achieving the goal of smart grid development represent effective ways of avoiding technical risks and reducing the early stage investment requirements. These actions also represent a rational choice for major countries under the background of economic globalization.

This chapter compares the development backgrounds and infrastructure status of various countries based on five aspects and presents an overview of the smart grid and the electricity dynamic pricing development situations in the United States, European Union, Japan and China. Moreover, this paper discusses the research results produced by smart grid and electricity dynamic pricing projects in different countries, summarizes their achievements and challenges, and provides a roadmap for national policy makers and power companies through which they can better orientates the development of smart grid and electricity dynamic pricing.

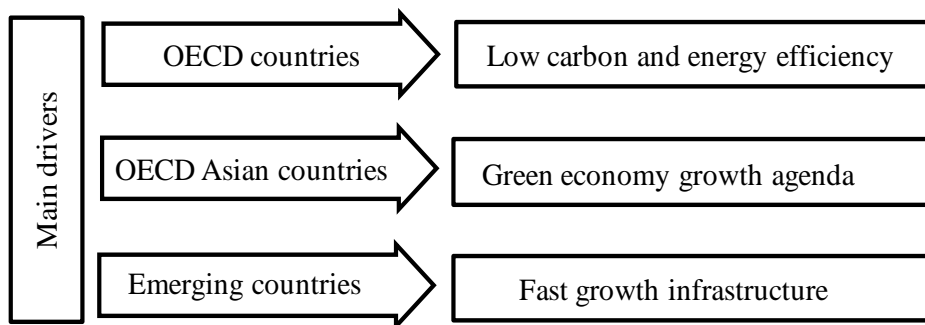

Figure 2-1 Main Drivers in Smart Grid and Dynamic Pricing Development

**CHAPTER TWO: SURVEY ON THE DEVELOPMENT STATUS AND CHALLENGES OF  
SMART GRIDS AND DYNAMIC PRICING  
IN MAIN DRIVER COUNTRIES**

**2.2 Survey on the Development Status and Challenges of Smart Grids**

**2.2.1 Basic information of Smart Grids**

✧ Definitions of smart grids

SGs Definitions can well represent the development needs of national or regional electricity. It is just a different ways of articulating the development of the electricity system. However, the conceptual consistency also needs to be guaranteed among various working groups in order to do analysis and create high-quality standards. Table 1 shows the selection of SG definitions. Even six different definitions exist and different viewpoints on the definition of SGs remain, but the above do provide reasonable consistency. In brief, the principal parameters of SGs can be summarized as follows: (1) Digitization, two-way communication and automatic monitoring; (2) Accommodating all generation and storage options: integrating renewable and energy storage in electricity network; (3) Self-healing from power disturbance events: with necessary maintenance of self-adaptive networks; (4) Enabling new products, services and markets; (5) Demand response and energy management system for lowering peak demand and overall load; (6) Enabling active participation of end-users and provide more user options; (7) Optimizing assets and operating efficiently and resiliently.

✧ Characteristics of smart grids

Although different viewpoints on the definition of smart grids remain, the basic characteristics of smart grids can be summarized as shown in Table 2-2, in which compatibility, flexibility and high efficiency are the basic characteristics of smart grids. Serviceability and safety are auxiliary characteristics of smart grids, and interoperability represents the backbone. Figure 2-2 shows the interoperability layer of smart grids. From the category viewpoint, the interoperability layer can be divided into three essential parts: organizational part, informational part and technical part. Moreover, each layer can also be subdivided due to the complexity of smart grids' function. Generally speaking, the achievement of each layer depends on the achievement of multiple sub-layers.

**CHAPTER TWO: SURVEY ON THE DEVELOPMENT STATUS AND CHALLENGES OF  
SMART GRIDS AND DYNAMIC PRICING  
IN MAIN DRIVER COUNTRIES**

Table 2-1 Definitions of SGs

Organizations	Definition
International Electrotechnical Commission (IEC)	An electricity network that can intelligently integrate the actions of all users connected to it – generators, consumers and those that do both – in order to efficiently deliver sustainable, economic and secure electricity supplies.
USA National Institute of Standards and Technology(NIST)	A modernized grid that enables bidirectional flows of energy and uses two-way communication and control capabilities that will lead to an array of new functionalities and applications [4]
Institute of Electrical and Electronic Engineers (IEEE)	A large ‘System of Systems’, where eachq functional domain consists of three layers: (i) the power and energy layer, (ii) the communication layer, and (iii) the IT/computer layer. Layers (ii) and (iii) above are the enabling infrastructure thatq makes the existing power and energy infrastructure ‘smarter’.
EU European Commission (EC)	Energy networks that can automatically monitor energy flows and adjust to changes in energy supply and demand accordingly; Reach consumers and suppliers by providing information on real-time consumption; Better integrate renewable energy.
European Regulators’ Group for Electricity and Gas (ERGEG)	An electricity network that can efficiently integrate the behavior and actions of all users connected to it like generators, consumers and those that do both—in order to ensure an economically efficient, sustainable power system with low losses and high levels of quality and security of supply and safety.
Japan Smart Community Alliance (JSCA)	A system that can promote the greater use of renewable and unused energy and local generation of heat energy for local consumption and contribute to the improvement of energy self-sufficiency rates and reduction of CO2 emissions. Provide stable power supply and optimize overall grid operations from power generation to the end user.
China State Grid of China(SGCC)	An integration of renewable energy, new materials, advanced equipment, information technology, control technology and energy storage technology, which can realize digital management, intelligent decision making and interactive transactions of electricity generation, transmission, deployment, usage and storage.



**CHAPTER TWO: SURVEY ON THE DEVELOPMENT STATUS AND CHALLENGES OF  
SMART GRIDS AND DYNAMIC PRICING  
IN MAIN DRIVER COUNTRIES**

Table 2-2 Key Characteristics of Smart Grids

Source: [3, 21]

Characteristics	Contents
Compatibility	Accommodates all generation options; Deployment includes the integration of various types of distributed resources (renewable energy, small-scale combined, power and energy storage, etc.)
Flexibility	Flexible power resources; enables informed participation by customers (Demand response); New controllable loads (electric vehicles);
High efficiency	Digital information and advanced technologies; dynamic optimization of power resource allocation; enhanced system operating efficiency
Serviceability	Enables new products, services and markets; provides the necessary power quality for a range of needs; integration of smart appliances and consumer devices
Safety	Self-healing ability; resiliency to disturbances, attacks and natural disasters
Interoperability	Deployment of smart metering; control and visualization technologies; information communication technologies

✧ Technological systems of smart grids

Smart grids play an important role in current and future grid construction. Moreover, the critical issues concerning smart grids can mainly be defined as technologies (including equipment, skills, systems, services, infrastructure, software and components) that are currently available or are expected to be available in the near future. According to the previous studies and many academic surveys concerning smart grids, the relevant technologies can be mainly divided into technologies for the transmission system, technologies for the distribution system, and technologies for the demand side. In addition, classifying these technologies by function can be performed as follows: ① monitoring and control technologies for power transmission and distribution systems, (eg: coordinated control system with distributed power and customer side, etc) ② energy management technologies for the demand side, (eg: energy management system, HEMS, BEMS, FEMS and interconnection technologies for electric vehicles, etc) ③ possible advanced technologies to enable the effective operation of systems, (eg: superconductive power transmission and power electronics application equipment, etc) and ④ advanced interface technologies (eg: AMI smart meter and power conditioner technology, etc). Additional details are depicted in Figure 2-3.

**CHAPTER TWO: SURVEY ON THE DEVELOPMENT STATUS AND CHALLENGES OF  
SMART GRIDS AND DYNAMIC PRICING  
IN MAIN DRIVER COUNTRIES**

Categories	Layers	Description
Organizational	Economic/Regulatory Policy	Political and Economic Objectives as Embodied in Policy and Regulation
	Business Objectives	Strategic and Tactical Objectives shared between Business
	Business Procedures	Alignment between Operational Business Process and Procedures
Informational	Business Context	Awareness of the Business Knowledge Related to a Specific Interaction
	Semantic Understanding	Understanding of the Concepts Contained in the Message Data Structures
	Syntactic Interoperability	Understanding of Data Structure in Messages Exchanged between Systems
Technical	Network interoperability	Mechanism to Exchange Messages between Multiple systems across a Variety of Networks
	Basic connectivity	Mechanism to Establish Physical and Logical Connections between Systems

Figure 2-2 The Interoperability Layer of Smart Grids

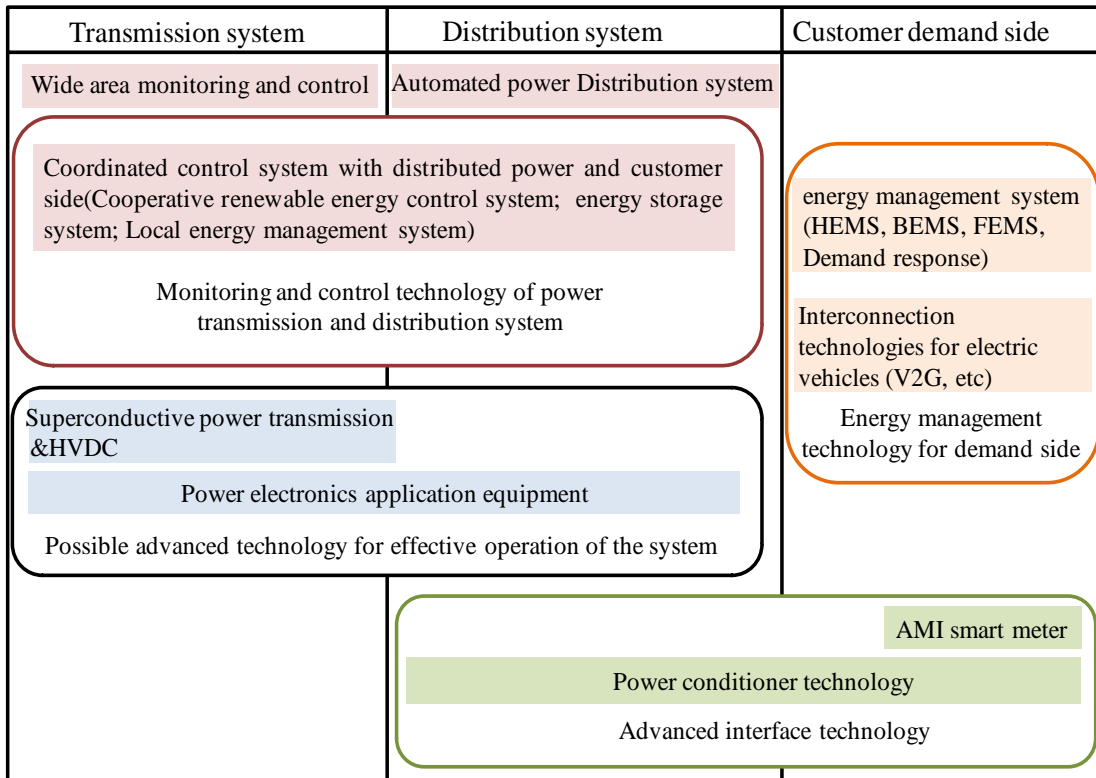

Figure 2-3 Interoperability Layer of Smart Grids

## CHAPTER TWO: SURVEY ON THE DEVELOPMENT STATUS AND CHALLENGES OF SMART GRIDS AND DYNAMIC PRICING IN MAIN DRIVER COUNTRIES

### 2.2.2 Development background and infrastructure of Smart Grids

The issues of energy shortage and environmental pollution have raised attention of many countries. According to the report and data from World Resources Institute, the worldwide greenhouse gas emissions (GHG) by sectors from 1990 to 2014 continues to increase even such kind of problems have already been called attention over the last two decades. What's more, it also tells that the GHG which caused by energy has accounts for majority of total GHG emissions. In the International Energy Outlook 2016 (IEO2016) Reference case, world energy-related CO<sub>2</sub> emissions increase from 32.3 billion metric tons in 2012 to 35.6 billion metric tons in 2020 and to 43.2 billion metric tons in 2040. The awareness of the environmental impact and the carbon footprint of all energy sectors keep increasing.

In conjunction with this phenomenon, de-carbonization has been put forward by many researchers and unions. Two elements are highlighted as important for de-carbonization what are improved energy efficiency and increased shares of renewable energy. Utilize energy more efficiently at all stages of the energy chain from its production to its final consumption is meaningful for the reduction of GHG, and thereby to mitigate the climate change. In addition, traditional energy shortages and serious environmental pollution problems have compelled many countries to develop environmentally friendly renewable energy so that they can reduce their dependence on traditional energy resources, realize reductions in environmental pollution caused by rising energy demand, and ensure sustainable social and economic development. However, compared to traditional energy, many renewable energy sources exhibit randomness and intermittency. A large amount of renewable energy generation in a power system, whether in large-scale centralized systems or small-scale distributed systems, can adversely impact the safety and reliability of traditional power systems. Therefore, sophisticated control systems were needed to facilitate the connection of sources to the highly controllable grid. In such cases, SGs play a pivotal role in renewable-based low-carbon energy systems while providing an essential platform to enable renewable energy generation in the central grid.

In order to correspond to these elements, SGs is essential to the realizing decarbonization from the energy sector. In addition, the viewpoint of nuclear-free from energy sector appears many times in recent years owing to the vulnerabilities and insecurities of nuclear power even nuclear resource is friendly to the environment. In other words, the emissions of GHG from the energy sector can be eliminated with technologies that are now available or foreseeable. This can be realized while creating a much more effective energy system than before. The traditional electricity grid has no potential to provide enough services addressing energy efficiency and the integration of RE at the scale needed to meet the clean-energy demand for the future. Therefore, introduction of SGs is an essential requirement that reduces GHG.

Concerning the organizational and incentive perspective, America and Europe follow the most similar modes. Both have government-dominated systems, making smart grid development a national development strategy through legislation. Moreover, the government provides special funds to support research and demonstration projects. Japan uses a special operation mode wherein government, industry and academic institutions jointly promote smart grids. The government (METI) provides policy supervision and creates a favorable business environment; industry (NEDO) and academic institutions lead research and demonstration projects. In China, smart grids were included in the national development strategy and in the 12th Five-Year Plan.

## CHAPTER TWO: SURVEY ON THE DEVELOPMENT STATUS AND CHALLENGES OF SMART GRIDS AND DYNAMIC PRICING IN MAIN DRIVER COUNTRIES

The government supports the research work in the form of national science and technology projects. The demonstration and construction of SGs has been led by the grid company.

Concerning supervision and tariffs, America and Europe have strong regulations and market mechanisms, where they have applied a terminal price; have experience implementing real time pricing (RTP), critical peak pricing (CPP), peak time rebate (PTR) and time-of-use (TOU) prices; and have facilitated the implementation of automated demand response and distributed energy. Japan has only introduced various types of TOU price systems. Some regional pilot programs have implemented CPP prices. China continues to employ time-invariant electricity pricing, although some regional pilot programs have introduced TOU pricing. Clearly, there is a large gap between China and the other two countries and Europe in terms of electricity tariff mechanisms.

In terms of customer features, China exhibits significant differences from other countries. In America, Europe and Japan, residents consume a higher proportion of electricity, generally approximately 30%. However, in China, industry consumes a higher proportion of electricity. Residential electricity consumption accounts for a relatively small proportion, generally approximately 15.1% in 2014.

Concerning energy structure, America and Europe have a uniform distribution and rational structure. In Japan, most of the energy resources rely on imports from abroad, which reveals the large demand for the utilization of renewable energy. In addition, renewable energy in these two countries and Europe is provided to the grid mainly in a distributed manner. In addition, all these countries utilize fuel- and gas-fired generators. In contrast to America, Europe, and Japan, the energy and load distribution of China is unbalanced; electricity must be transmitted over long distances, ranging from 1000 and 3000 km and must be provided with a wide-range configuration due to power resources (mostly located in northern and western China) being far from power demand centers (usually located in central and eastern China). Renewable energy, such as wind power, is provided to the grid mainly in concentrated forms. The power grid is dominated by thermal power plants instead of gas, oil and other plants, which can achieve higher efficiencies.

Concerning management, the management of smart grids in America and Europe is decentralized. Moreover, the formulation of widely recognized standards is a time-consuming process because there are many stakeholders and suppliers involved in the electricity system. In Japan, there are only 10 electricity companies divided up by area, and grid ownership and management is relatively decentralized. The government directs energy consumption, and power companies must implement corresponding policies. Compared to America, Europe, and Japan, China's power grid has a relatively concentrated ownership and control structure, which favors unified planning and scheduling.

**CHAPTER TWO: SURVEY ON THE DEVELOPMENT STATUS AND CHALLENGES OF  
SMART GRIDS AND DYNAMIC PRICING  
IN MAIN DRIVER COUNTRIES**

**2.2.3 Development status and achievements of Smart Grids**

✧ Policy support

In United States, European Union, Japan and China, there are numerous smart grid stakeholders due their wide variety of functions and applications. Both power company providers and common stakeholders are integral aspects of smart grids. Therefore, how to form a balance under such complex situations is essential to the continued development of smart grids. Here, policy plays an important guiding role in this process. Clear policy can be used to establish a good external development environment for smart grids while facilitating the coordination and cooperation of all related parties involved in smart grids.

Smart grids are extremely complex systems and contain many items which including generation, transmission, substation, distribution, consumption, power dispatch, and information platforms. Any policy that related to these areas can be concluded to smart grids. Table 2-3 summarizes the policy support for smart grids among the three selected countries and Europe. It is evident that America, Japan, Europe, and China have published several regulations to support the development of smart grids at a very early age.

Smart grid policies in America and Europe are mainly issued by states. These two governments organize and guide the construction of smart grids through legislative actions and release policy framework reports. Among them, the United States has focused on formulating policy related to the upfront investment in an attempt to motivate private investment and stimulate the long-term involvement of all stakeholders to promote the development of smart grids. Europe, as an active promoter in the reform of world energy generation, has concentrated their smart grid policies on low-carbon programs. Energy supply security is their target objective. Japan has focused on the deployment of renewable energy in an attempt to improve their energy self-sufficiency while affirming the importance of smart grids in its new energy structures. The government of China, as a representative of emerging countries, has issued a series of support policies for renewable energy development and energy savings. Since 2010, the implementation of Smart grids (SGs) has been promoted as a national strategy.

Table 2-3 Policy Support for Smart Grids

Source: [38-51]

Countries	Time issued	Policy Support	Main Contents
America	2007	EISA	Commitment to allocate state-owned special funds; Support NIST to compile standards system for SGs; Coordination of nationwide SG standardization
	2009	ARRA	Commission Department of Energy grants totaling \$4.5 billion of government funds; Motivate domestic private investment into SGs; Support the research and demonstration of SGs
Europe	2008	EEPP	Indicate that green technology plays a key role in the economic recovery plan; Stipulate considerable portion of funds should be used for electricity interconnection and Offshore wind projects

**CHAPTER TWO: SURVEY ON THE DEVELOPMENT STATUS AND CHALLENGES OF  
SMART GRIDS AND DYNAMIC PRICING  
IN MAIN DRIVER COUNTRIES**

	2009	Third Legislation for Further Liberalization of the Electricity and Gas Markets	States to further liberalize the electricity markets to facilitate greater supplier competition and consumer choice
	2010	European Council summits	Encourage the investigation of energy infrastructure, research and innovation projects; Guarantee the security of EU energy supply system; address climate change
	2012	Energy Efficiency Directive 2012/27/EU, the European Commission	Clear focus on achieving the overall energy efficiency target of reducing primary energy consumption by 20% by 2020.
	2014	Regulation [EU] No 333/2014 and No 517/2014 on Carbon dioxide emissions	It have updated and strengthened the existing climate policies.
Japan	2009	Policy Package to Address the Economic Crisis	Advocate the development of solar power generation, energy-saving appliances and low-fuel-consumption cars; Attempt to realize an installed solar power generation capacity of 28 million kW by 2020
	2010	Report of the next-generation power transmission and distribution network	Emphasis on the stability of power systems; Set encouragement strategies for improving distribution systems and developing battery technologies; Guarantee a power supply during system accidents;
	2010	New Strategic Energy Plan	Establish 3E energy viewpoint (energy security; environment; economic efficiency); Promote the development of SGs
	2014	Fourth Basic Energy Plan	Concentrates on the policy objectives of energy reliability, security, affordability, efficiency, and reduced emissions.
China	2006	Renewable energy pricing and cost-sharing (pilot management scheme)	Stipulate two types of pricing mechanisms: government-directed pricing and government-guided pricing.
	2006	Management measures on auxiliary service in power system 2006	States that power plants will provide two kinds of ancillary services: basic ancillary services and paid ancillary services
	2010	Renewable energy law	Stipulate full protective purchase of renewable electricity.

**CHAPTER TWO: SURVEY ON THE DEVELOPMENT STATUS AND CHALLENGES OF  
SMART GRIDS AND DYNAMIC PRICING  
IN MAIN DRIVER COUNTRIES**

2012	Twelfth Plan related to major science technology industrialization projects of Smart Grid	Five-Year and	Present the development ideas and principles of SG; Establish general development objectives; Perform nine key tasks
2013	Financial subsidy for distributed PV project		Give subsidy for distributed PV based on resource conditions that related to distributed energy in SGs

◇ Investment

Investment is the economic foundation for the development of smart grids. Generally speaking, the landscape of smart grids is highly dynamic and rapidly changing, with emerging economies as major players in smart grid investment. Table 2-4 shows the investment situation of smart grids in various countries.

Clearly, America, Europe and China have invested substantial funds into the development of smart grids. In contrast to those countries and Europe, Japan invested only \$849 million to develop its SG in 2009. Prior to the Fukushima nuclear crisis, the energy supply structure of Japan was stable and secure. At that time, some people even believed that a smart grid did not need to be developed. Therefore, in terms of past funding for smart grids, the investment by Japan has not been as strong as that of other countries. However, the promotion of efficiency and reliability of energy over the last three years has ultimately forced all utilities to make plans for the development of smart grids. The investment in smart grids in Japan will increase from approximately \$1 billion in 2011 to \$7.4 billion in 2016.

Europe has invested the most money (\$261 billion) in the development of SGs. Europe also forecasts that it will increase its investment in SG development to \$79 billion by 2020 [54]. Concerning America, Table 2-3 shows that it will increase investment to \$338 to \$476 billion in its SG implementation. The costs allocated to transmission and substations are between 19% and 24% of the total cost, the costs allocated to distribution are between 69% and 71%, and the costs allocated to consumer systems are between 7% and 10%. In China, SGCC is solely responsible for the development of nationwide SGs. A total of \$101 billion will be provided to support future SG development. Compared to Europe, America and China will provide greater funding to the future study of SGs. Concerning smart meter deployment, America and Europe have already deployed a large number of smart meters; in contrast, China remains in the planning stage. In Japan, 10 major utilities have planned to begin widespread smart meter rollouts between 2016 and 2024, by which time an expected 82 million units will be in place for residential and low-use customers.

Concerning funding allocation, we only analyze America and Europe because Japan and China have relatively simple stakeholder systems for SGs. Funding in America is mainly provided by SGIG (Smart grid Investment Grant). Figure 2-4 illustrates SGIG funds by type of recipient. Clearly, investor-owned utilities account for the largest proportion, followed by public power utilities. Figure 2-5 shows the distribution of European funding across leading organizations. In contrast to America, DSO/Utility/Energy companies spent the greatest proportion of the funds, reaching 55%, followed by University/Research center/Consultancy.

**CHAPTER TWO: SURVEY ON THE DEVELOPMENT STATUS AND CHALLENGES OF  
SMART GRIDS AND DYNAMIC PRICING  
IN MAIN DRIVER COUNTRIES**

Table 2-4 Investments in Smart Grids

Source: [53-60]

Countries	Forecast investments	SG	Funding for SG development	Smart meters deployments & plans (number)
America	\$338 to 476 billion by 2030 [55]		\$7 billion in 2009 [57]	8 million in 2011; 60 million by 2020 [58]
Europe	\$79 billion by 2020 [55]		\$261 billion	45 million already installed; 240 million by 2020 [54]
Japan	\$7.4 billion by 2016 [53]		\$ 849 million in 2009 [57]	82million by 2023 [59]
China	\$101 billion [56]		\$ 7.3 billion in 2009 [57]	360 million by 2030 [60]



**CHAPTER TWO: SURVEY ON THE DEVELOPMENT STATUS AND CHALLENGES OF  
SMART GRIDS AND DYNAMIC PRICING  
IN MAIN DRIVER COUNTRIES**

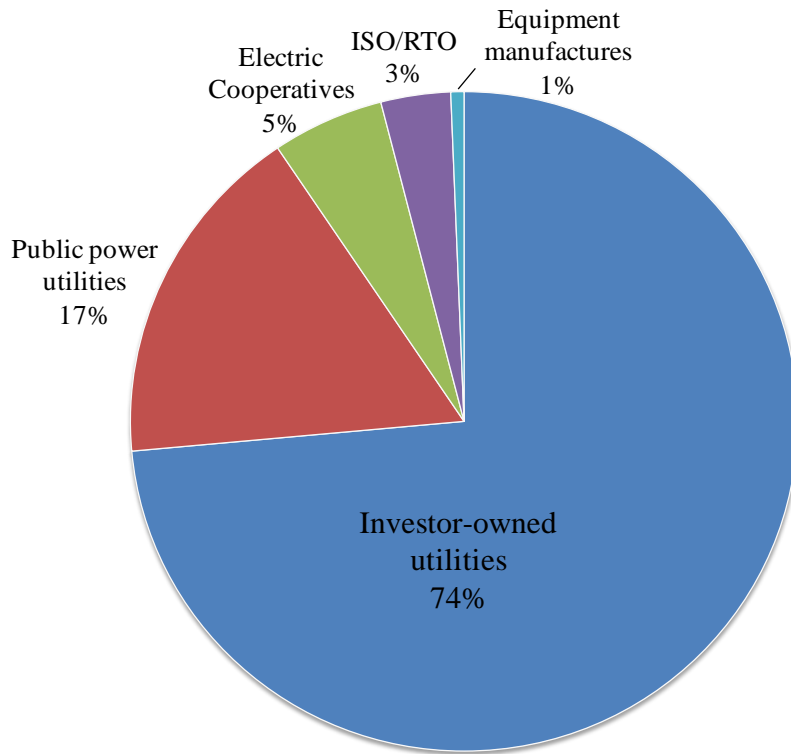

Figure 2-4 SGIG funds by type of recipient [61]

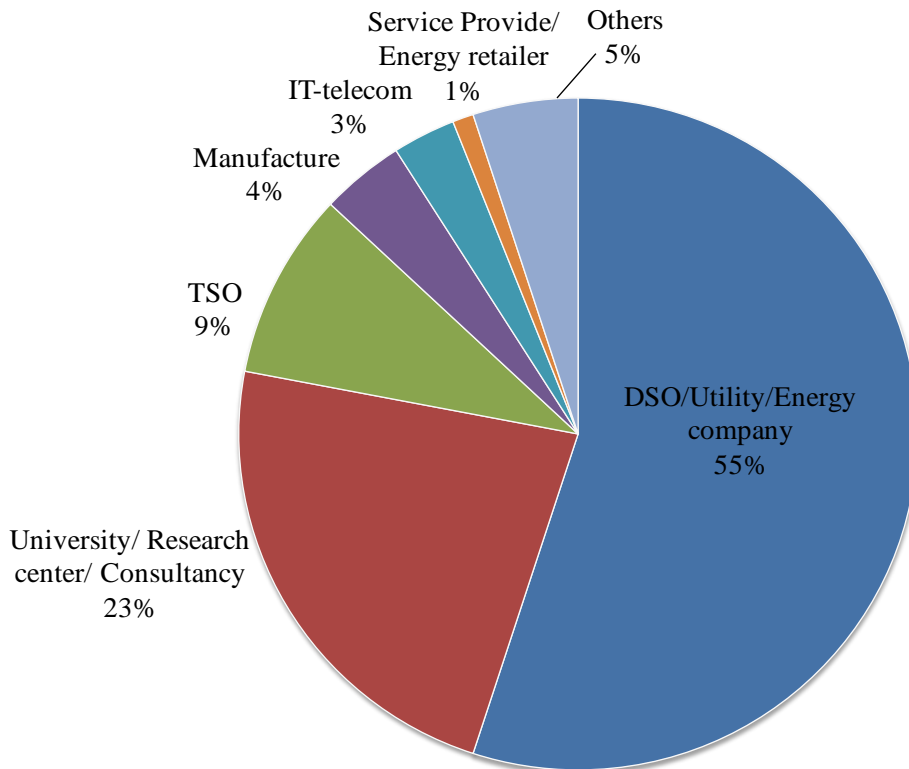

Figure 2-5 Distribution of EC funding across leading organizations [62, 63]

**CHAPTER TWO: SURVEY ON THE DEVELOPMENT STATUS AND CHALLENGES OF  
SMART GRIDS AND DYNAMIC PRICING  
IN MAIN DRIVER COUNTRIES**

✧ Projects and achievements

Over the past decade, various countries have strengthened their SG research with increasing demonstrations and policies. Current situation of SGs projects play an important role in terms of formulating a clear future direction for SGs. Table 2-5 shows the categories for the classification of SG projects in the above three countries and Europe. The table shows that the demonstration projects in America, Europe and Japan concentrate on the deployment of advanced and digital electricity systems (introducing smart meters, etc.) while focusing on the application of renewable energy and distributed generation. In addition, America, Europe, and Japan also attempt to provide a greater number of new services to customers such as smart houses and storage batteries. However, China continues to focus on developing its electricity infrastructure and ensuring a “unified, strong and smart grid network”.

Table 2-5 Categories for the classification of SG projects in various countries and the European Union

Source: [64, 65]

America	European Union	Japan	China
Advanced Infrastructure	Metering Smart Network Management	Renewable energy generation	Generation
Electric Systems	Transmission Integration of DER	Renewable energy utilization	Transmission
Electric Distribution Systems	Integration of large scale RES	Renewable energy utilization	Transformation
Integrated and crosscutting Systems	Aggregation (Demand Response, VPP)	Electricity network	Distribution
Customer Systems	Smart Customer and Smart Home	Customer systems	Utilization
Storage Demonstration	Electric Vehicles applications	Transportation	Dispatch
Equipment Manufacturing	Other (please specify)		

Figure 2-6 presents the proportion of project numbers by technology application in America and Europe. The figure shows that both America and Europe have attached great importance to the study of smart network management, aggregation of DR and VPP and smart consumers and smart house technologies. In addition, Europe prefers to research the integration of DER and electric vehicle technologies, and America prefers to study smart meters.

Table 2-6 shows the detailed demonstration project situation of SGs in Japan. In four demonstration areas, Japan has studied technologies related to SGs, including energy use visualization, home appliance control, demand response, family electric vehicles (EVs) and optimization of power storage systems, while attempting to achieve optimal energy utilization through energy management system (EMS). The implementation of the four demonstration projects not only represents technical tests but also helps create new business models toward providing new services.

**CHAPTER TWO: SURVEY ON THE DEVELOPMENT STATUS AND CHALLENGES OF  
SMART GRIDS AND DYNAMIC PRICING  
IN MAIN DRIVER COUNTRIES**

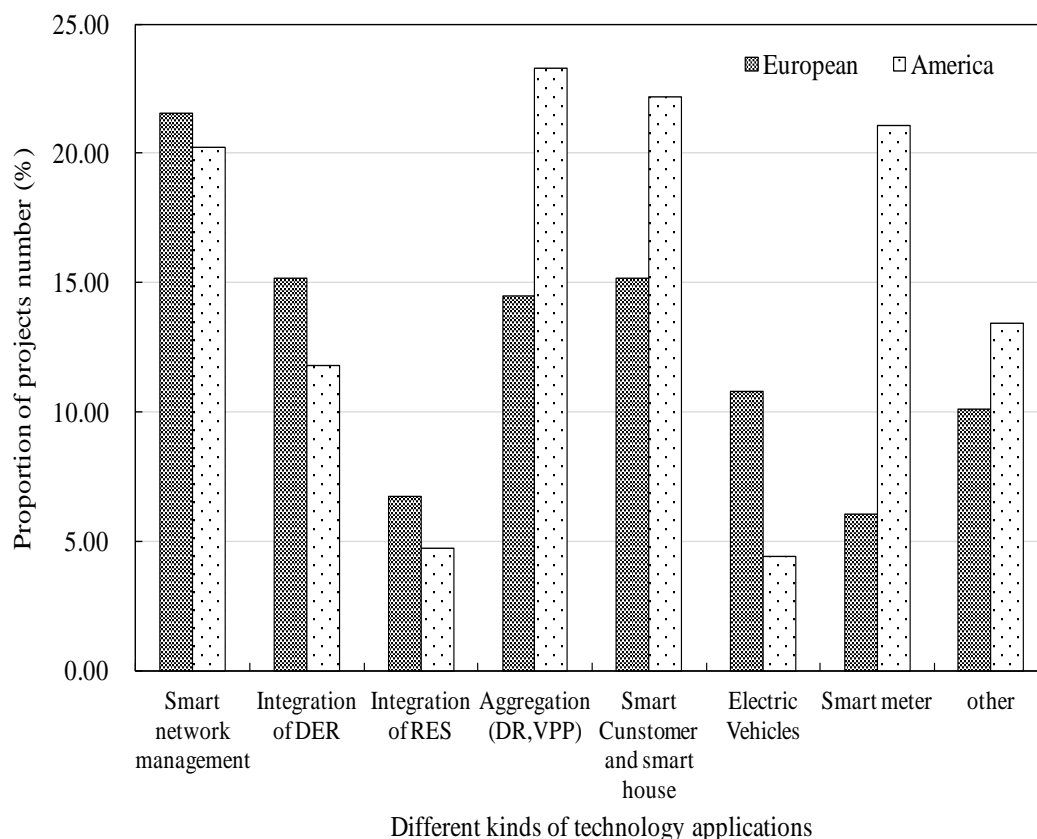

Figure 2-6 Proportion of the projects by technological application [66, 67]

The SGCC also strongly promotes the development of SG projects in China. The SGCC organized 26 provincial branches to conduct SG pilot projects, arranging in total 303 projects across 32 categories, and completed 269 projects across 29 categories. Moreover, the SGCC constructed distribution automation systems in 64 central urban spaces, which enhanced the intelligence of the distribution network. In addition, it also built 360 electric vehicle charging stations and placed them into operation in 26 provinces, thereby stimulating the rapid development of industries related to electric vehicles.

✧ Standardization

As for the existing international SGs standards, the common recommended core standard is IEC TC 57. According to the number of recommendations and the perspective of most experts, we select four standards come from TC 57 to have a description which of highest importance from the perspective of most experts. One IEEE standard also been taken into consideration, however it doesn't have much impact on worldwide scale [18]. The standardization of SGs in various countries is shown in Table 2-7. Clearly, America and Europe play leading roles in international standardization efforts due to their rich experience and mature SG development system, whereas Japan and China play a supporting role as a result of their SG development statuses.

NIST and SGIP are responsible for the standardization work for SGs in America. Under the guidance of EISA 2007, NIST developed the SG standards system in 2009 and published the "Framework and roadmap for smart grid interoperability standards," version 1.0 and version 2.0 [68, 69]. In addition, to facilitate America SG standardization and attract stakeholders to participate in the standardization efforts, NIST subsequently established SGIP. With the impetus

## CHAPTER TWO: SURVEY ON THE DEVELOPMENT STATUS AND CHALLENGES OF SMART GRIDS AND DYNAMIC PRICING IN MAIN DRIVER COUNTRIES

and guidance of SGIP, America has completed a series of SG standards revision works and have formulated a standard library (Category of Standards, CoS) [70]. Although these standards have not yet been widely recognized, the SGIP's work has been highly valued by the Federal Energy Regulatory committee (FERC). These standards have also laid a firm foundation for the internationalization of the America SG standards. The Joint Working Group (CEN, CENELE, ETSI) is responsible for the development of the SG standardization roadmap of Europe [71]. That group transformed into a permanent organization, namely, the Smart Grid Coordination Group (SGCG), which continues to be responsible for coordinating and guiding the European SG standardization efforts. The key points of European SG standardization can be categorized into two aspects: setting Europe standards for electric vehicles and electric meters and making recommendations to international standardization organizations [72]. The SG standardization effort of Japan was lead by the Japanese Industrial Standards Committee (JISC), which mainly focused on the standardization of the related technology in favor of cooperation among various companies [73]. SGCC was responsible for China's SG standardization. In 2010, SGCC published the "Framework and roadmap for strong and smart grid standards" [74] and released a series of detailed SG standards that represent an important component of SG international standardization.

**CHAPTER TWO: SURVEY ON THE DEVELOPMENT STATUS AND CHALLENGES OF  
SMART GRIDS AND DYNAMIC PRICING  
IN MAIN DRIVER COUNTRIES**

Table 2-6 Demonstration projects for SGs in Japan

Source: [65]

			Yokoha ma	Toyot a	Kyot o	Kitakyus hu
Renewable generation	energy	Solar power generation	●			●
		Wind power generation				●
		Cogeneration				●
Renewable utilization	energy	Solar heat	●			
		Biomass			●	●
		Waste energy (Rubbish, water reclamation, sewage sludge)	●		●	●
Electricity network		By-product energy	●			●
		Regional air conditioning	●			
		Superconducting and transmission network	●			●
Customer systems		Storage batteries	●	●	●	●
		CEMS · HEMS · BEMS · FEMS	●	●	●	●
		Demand response (DR)	●	●	●	●
Transportation		Two-way communication	●	●	●	●
		Smart house/building/ industry	●	●	●	●
		Storage battery	●	●	●	●
		EV · PHV	●	●	●	
		EV charging infrastructure	●	●	●	●
Consult University		Advancement of the transportation system	●	●	●	●
		Comprehensive Solution	●			
		Industry-university cooperation	●	●	●	●

**CHAPTER TWO: SURVEY ON THE DEVELOPMENT STATUS AND CHALLENGES OF SMART GRIDS AND DYNAMIC PRICING  
IN MAIN DRIVER COUNTRIES**

Table 2-7 Standardizations of SGs in various countries

Source: [68-70,72-76]

Countries	Leading organization	Time issued	Main SG Standards	Main contents
IEC TC 57 (International Electrotechnical Commission Technical Committee 57)		2003	IEC 60870 [12]	Define systems used for controlling electric power transmission grids and other geographically widespread control systems
		2006	IEC 62351 [13]	Focus on power system management and associated information exchange - data and communications security
		2007	IEC 61970 [11]	Deals with the application program interfaces for energy management systems (EMS)
		2009	IEC 62357 [14]	Focus on power system control and associated communications- object model, service facilities and protocol architecture with reference
IEEE (Institute of Electrical and Electronic Engineers)		2009	Draft Guide for Smart Grid Interoperability of Energy Technology and Information Technology Operation with the Electric Power System [17]	Focus on smart grid interoperability consisting of consistent terminology, characteristics, functional descriptions, evaluation criteria and appropriate development activities.
America	NIST (National Institute of Standards and Technology)	January, 2010	Framework and roadmap for smart grid interoperability standards Release 1.0 [74]	Identify 19 standards that require priority revision; Establish SGIP to attract various stakeholders to participate in the standardization efforts

**CHAPTER TWO: SURVEY ON THE DEVELOPMENT STATUS AND CHALLENGES OF SMART GRIDS AND DYNAMIC PRICING  
IN MAIN DRIVER COUNTRIES**

		February, 2012	Framework and roadmap for smart grid interoperability standards Release 2.0 [75]	
	SGIP (Smart Grid Interoperability Panel)	-	CoS (Catalog of Standards) [76]	Continued research on conceptual architectural framework and SG interoperability panel (SGIP); Focus on the standards identified for implementation and cybersecurity strategy; Discuss framework for SG interoperability testing and certification
Europe	Joint Working Group (CEN/CENELE/ETSI)	2009	Mandate CEN/CENELEC M/441 [15]	Focal topics of standardization like terminology, systems aspects, data communication reference architecture and data communication interfaces with the focus on sectional standards like e.g. DMS, SCADA, Data models, ERP interfaces. Another
		October, 2010	Report on standards for smart grids V1.0 [81]	Provide conceptual model and reference architectural principles; Conclude the framework of SG architecture model (SGAM); Set Europe standards for electric vehicles and electric meters; Make recommendations to the IEC and other international standardization organizations.
		June, 2011	Final report of the CEN/CENELE/ETSI Joint Working Group on Standards for Smart Grids [82]	
	SGCG (Smart Grid Coordination Group)	October, 2012	First, Set of Standards Version1.1[78]	

**CHAPTER TWO: SURVEY ON THE DEVELOPMENT STATUS AND CHALLENGES OF SMART GRIDS AND DYNAMIC PRICING  
IN MAIN DRIVER COUNTRIES**

Japan	JISC (Japanese Industrial Standards Committee)	December, 2012	Twenty important items for international standardization of SGs [79]	A total of 8 review groups select 20 important items for the international standardization of SGs, including energy management and demand response systems, distribution automation systems, smart meter systems, and technologies related to electric vehicles. METI encourage the application of HEMS and ECHONET, realizing the collaboration among different companies
	METI (Ministry of Economy, Trade and Industry)	February, 2012	Recommend HEMS and ECHONET lite [79]	
		2010	Japans Roadmap to International Standardization for Smart Grid and Collaborations with other Countries [16]	
China	SGCC (Smart Grid Corporation of China)	August, 2010	Framework and roadmap for strong and smart grid standards [80]	Establish a SG standard system based on integrated planning, generation, transmission, substations, distributions, communication and 2 other professional branches, involving 26 technical areas and consists of 92 standard series; Compile 220 enterprise SG standards and 841 national and industry standards



## CHAPTER TWO: SURVEY ON THE DEVELOPMENT STATUS AND CHALLENGES OF SMART GRIDS AND DYNAMIC PRICING IN MAIN DRIVER COUNTRIES

### **2.3 Survey on the Development Status and Challenges of Dynamic Pricing**

Smart grid and dynamic pricing is the hot research topic in recent electricity market. Smart grid is an essential scientific and technological innovation and reform trend of the power system in 21st century; Dynamic pricing is a new kind of pricing system which can realize the two-way communication in the power market, customers could change their electricity consumption behaviors according to the different price signals or incentive mechanisms. Smart grid and dynamic electricity prices are closely linked, the interaction between these two items can greatly promote the scientific development of the power industry. Moreover, smart grid is a technical prerequisite for many dynamic pricing projects, and dynamic electricity price is one of the best applications of smart grid. It is also can be considered that dynamic electricity price is an important component of the smart grid. In the precious section, we already give a comprehensive and detailed introduction of smart grid. Under this background, due to the similarity of smart grid and dynamic electricity price in some area (eg: development background and infrastructure; policy support and standardization), we will only introduce the unique features of dynamic electricity price in the following parts.

**CHAPTER TWO: SURVEY ON THE DEVELOPMENT STATUS AND CHALLENGES OF  
SMART GRIDS AND DYNAMIC PRICING  
IN MAIN DRIVER COUNTRIES**

**2.3.1 Basic information of dynamic price**

The idea of moving from time-invariant electricity prices to dynamic pricing, where price are more closely tied to variations in the marginal cost of generating electricity, has been around for at least fifty years. The marginal cost of electricity varies widely over time which caused by the electricity demand varies widely. As for electricity market, more electricity has been generated during peak periods and less during the night. And only those facilities with low operation costs are used in off-peak periods, like hydro-electric and nuclear facilities. Figure 2-7 and Figure 2-8 explain the unit cost for power generation and unit construction cost of power plants in Japan. When the electricity consumption of customers changes which lead to the demand increases, the production adapts itself and facilities whose variable costs are higher and higher begin to be used [75]. What's followed by the cost of electricity is rising. That is to say, if the peak electricity load appeared, the generation companies requiring extra power to continually adjust to meet peak demand sometimes at great cost. Moreover, electricity cannot be stored, the amount of electricity generated is therefore to be strongly correlated to the demand level. For these reason, how to lead users to the rational use of electricity and guarantee the optimal power resource allocation becomes a crucial problem. In order to solve this question, dynamic pricing system has been developed. As is shown in Figure 2-9, dynamic electricity price actually is a demand response method which needs the participation of both consumers and the power supply enterprises. Generally speaking, dynamic pricing is the charging of different electricity rates at different times of the day and year to reflect the time-varying cost of supplying electricity. It is more economic than the time-invariant pricing.

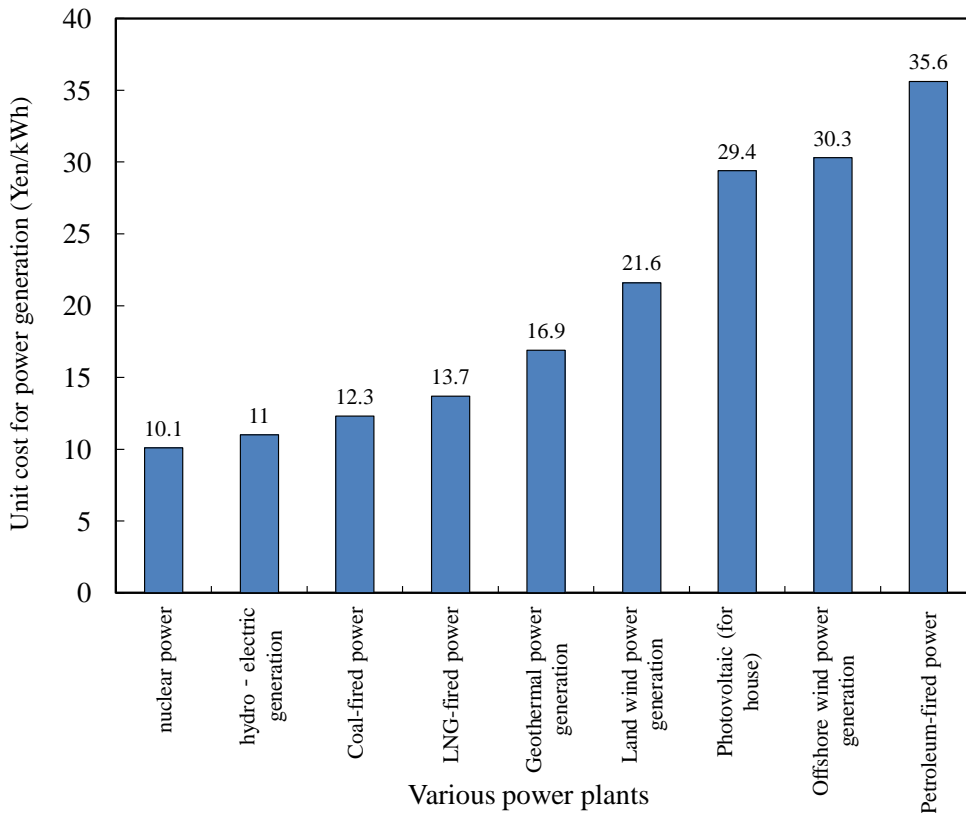

Figure 2-7 Unit cost for power generation in Japan [76]

CHAPTER TWO: SURVEY ON THE DEVELOPMENT STATUS AND CHALLENGES OF SMART GRIDS AND DYNAMIC PRICING IN MAIN DRIVER COUNTRIES

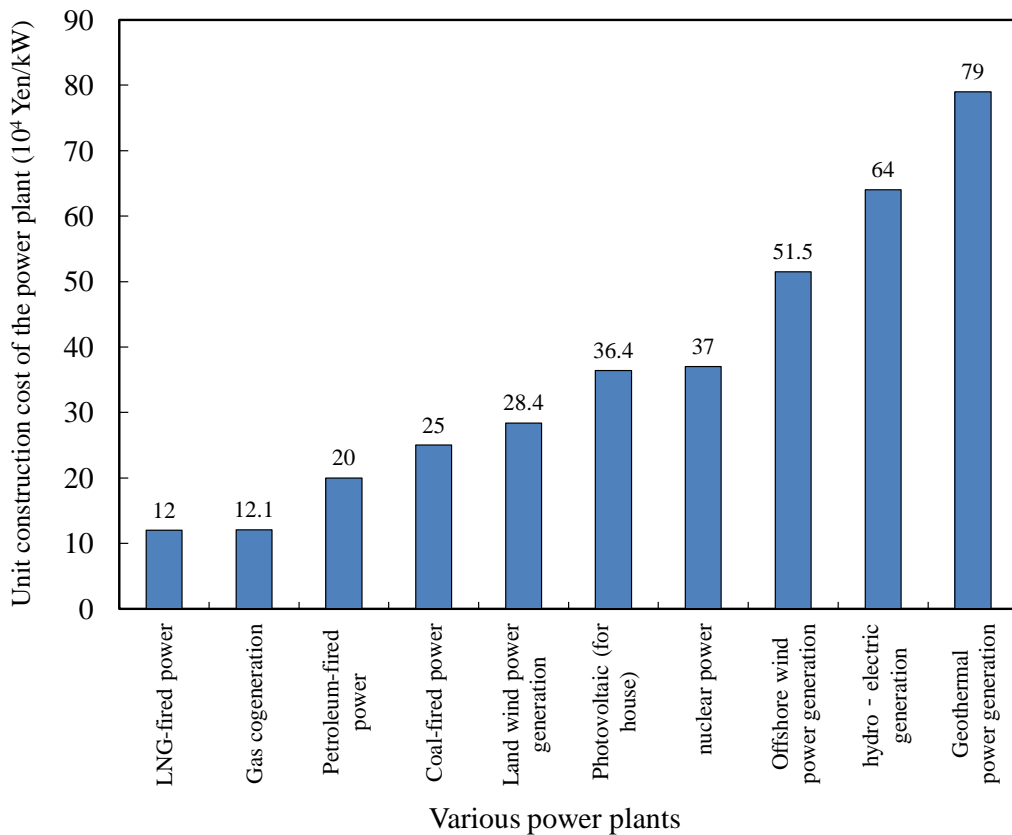

Figure 2-8 Unit construction cost of power plants in Japan [77]

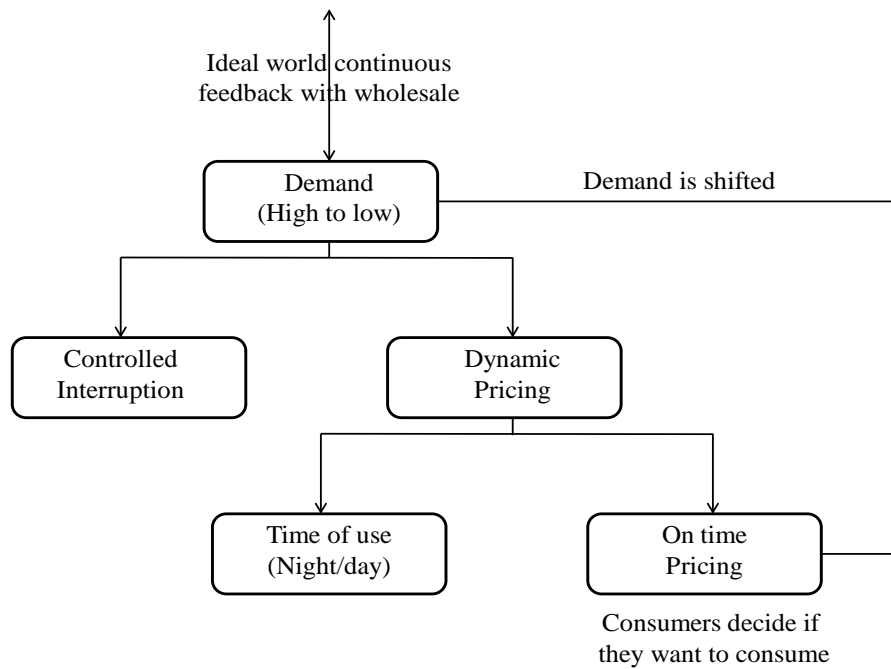

Figure 2-9 The way that dynamic pricing shift demand

## CHAPTER TWO: SURVEY ON THE DEVELOPMENT STATUS AND CHALLENGES OF SMART GRIDS AND DYNAMIC PRICING IN MAIN DRIVER COUNTRIES

### 2.3.2 Main method of demand response and electricity dynamic pricing

Demand response is the changes in electric usage by end-use customers from their normal consumption patterns in response to changes in the price of electricity over time, or to incentive payments designed to induce lower electricity use at times of high wholesale market prices or when system reliability is jeopardized. With the deployment of smart grid, there are many different methods to realize the demand response. Retail demand response to wholesale market conditions has several important benefits. In particular, it can relieve generation and transmission constraints, meanwhile, reduce the severity of wholesale price spikes, reduce potential market power on the part of generators, and lead to lower overall energy prices to all consumers.

Demand response is an important branch and development direction under the background of smart grid. It is also an important factor which could ensure the control of the terminal energy market during the process of designing electricity market. Historical experience shows that the lack of demand response is the main reason which results in the market disaster. For example, if the California electricity crisis that occurred in the United States in 2000 had a demand response system, it would not be so serious. Due to the importance of demand response, many organizations put it into a very important position while built their smart grid and electricity markets, some of them even provide the legislation support when considering the development of demand response.

The classification of demand response programs is shown in figure 2-10. It is obvious that the demand response programs can be divided into two essential parts, incentive based programs and price based programs. In terms of incentive based programs, it mainly has six branches, emergency demand response program, interruptible programs, direct load control, capacity market program, demand bidding and ancillary services market. Direct Load Control (DLC) is a program that considers a remote control or cycle of a customer's electrical equipment by the DR program operator. These programs are primarily offered to residential or small commercial customers; Interruptible/Curtailable Service (ICS) is based on curtailment options integrated into retail tariffs that provide a rate discount or bill credit by agreeing to reduce load during system contingencies. These programs are traditionally offered to larger industrial customers; In Demand Bidding (DBB) programs, customers offer curtailment capacity bids and large customers are normally preferred; Emergency DR program can be seen as a mix of DLC and ICS and is targeted for periods when reserve becomes insufficient; In Capacity Market (CM) programs, customers offer load reduction as system capacity to replace conventional generation or delivery resources; Ancillary Services Market (ASM) programs are basically similar to DBB programs, whereas in this case the offer is just made for the ancillary services market. Generally, the participants who involved in the incentive based programs will get the subsidy for encouraging their demand response activities. What's more, the price based programs are based on different tariff schemes. Each tariff scheme corresponds to one demand response method. There are mainly four common pricing systems, time of use pricing (TOU), critical peak pricing (CPP), extreme day CPP and real time pricing (RTP). The detail information of these tariff schemes will be introduced in next part of this section.

Figure 2-11 shows the integration of DR programs in the power system operation and planning, from a time horizon point of view, in the context of electricity market.

CHAPTER TWO: SURVEY ON THE DEVELOPMENT STATUS AND CHALLENGES OF SMART GRIDS AND DYNAMIC PRICING IN MAIN DRIVER COUNTRIES

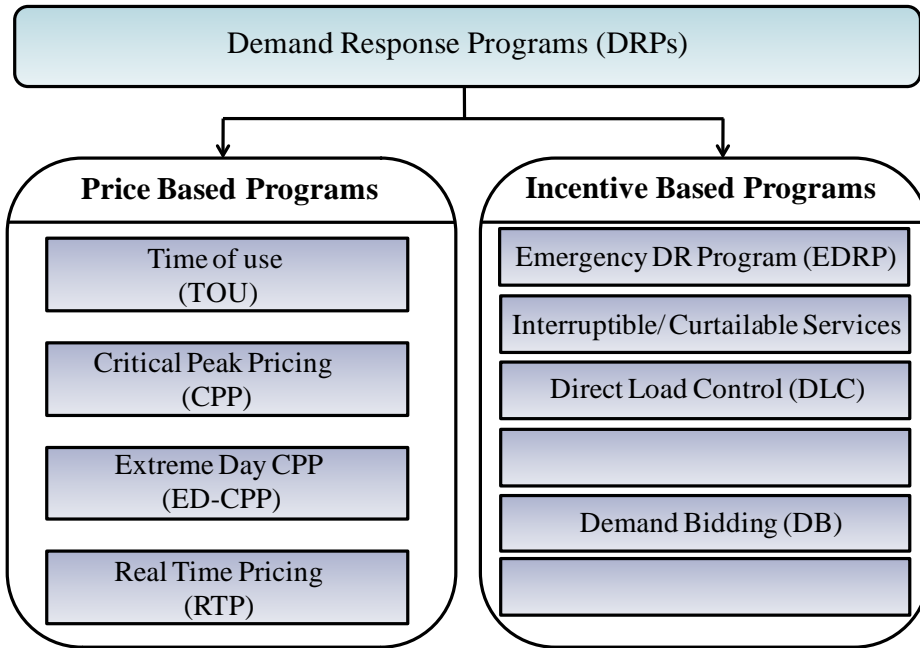

Figure 2-10 Classification of demand response programs

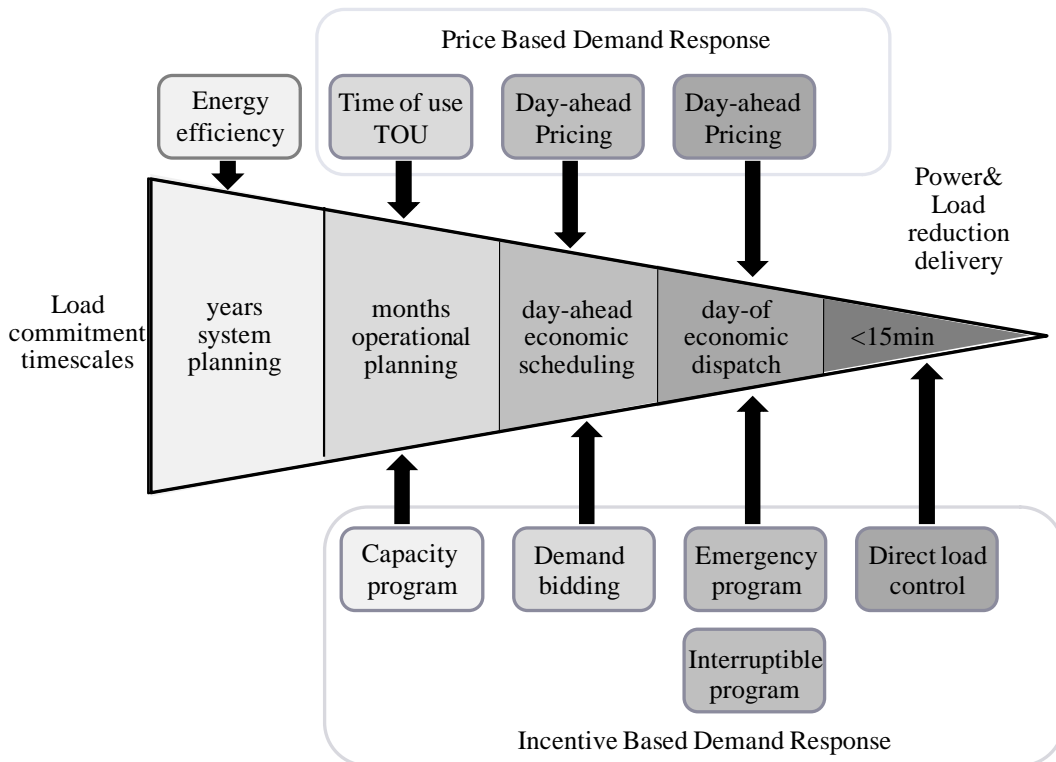

Figure 2-11 Demand response in electric system planning and operations

**CHAPTER TWO: SURVEY ON THE DEVELOPMENT STATUS AND CHALLENGES OF  
SMART GRIDS AND DYNAMIC PRICING  
IN MAIN DRIVER COUNTRIES**

Figure 2-12 shows the information of different types of electricity rates and pricing schemes. Most electricity rates currently in use in the world can be divided into two parts: static price and dynamic price. Static price include flat tariffs, block rate tariffs and seasonal tariffs. All kinds of static price have been decided for a relatively long time period which across several months or years. On the contrary, dynamic prices afford utilities many options which can change or dispatch prices on short time period in response to the temporary power system or wholesale pricing conditions. From Figure 2-12, it illustrates that dynamic price mainly include six categories, those are time of use (TOU) tariff, super peak TOU tariff, critical peak pricing, variable peak pricing, peak time rebate and real time pricing. In the following part, we will select several typical pricing systems as representatives to do an investigation of dynamic pricing method. The detailed concept and information can be illustrated as follows:

- (1) Flat Tariffs: Price remains static even though power demand changes. This kind of tariff

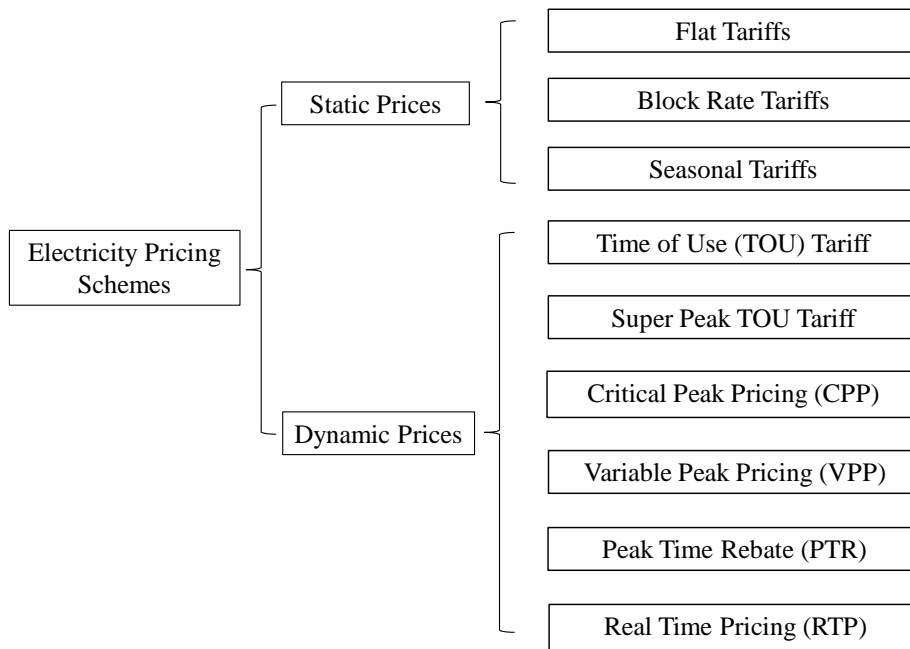

Figure 2-12 Types of electricity rates and pricing schemes

was common be used in the majority of developing countries. Consumers who with such a scheme don not need to face the changing costs of power supply with a change in aggregate demand. Moreover, consumers don't need to undertake any risk of high value electricity bills for any unavoidable or unplanned electricity consumption.

- (2) Seasonal Tariffs: These schemes observe different rates in different seasons to match the varying demand levels between seasons. Energy is charged at a higher rate during high demand seasons and the price lowers during low demand seasons. Generally, the electricity price of summer and winter is higher than that of other seasons, owing to the high cooling demand in summer and high heating demand in winter.
- (3) Time of Use (TOU): TOU is the most widely used system in the practical applications. In

## CHAPTER TWO: SURVEY ON THE DEVELOPMENT STATUS AND CHALLENGES OF SMART GRIDS AND DYNAMIC PRICING IN MAIN DRIVER COUNTRIES

TOU, the day is divided into contiguous blocks of hours. The price of a kWh varies between blocks, but not within blocks. Such schemes can stay effective for short or long terms. This is also known as time-of-day (TOD) tariff. The example of TOU pricing system was shown in Figure 2-13. It presents that the price of peak period is the highest price, followed by the price of middle and off-peak period. Super peak TOU tariff can also be considered as a kind of special TOU tariffs. The pricing mode of super peak TOU is similar to TOU but the peak period is shorter in duration so as to give consumers a stronger price signal.

- (4) Critical Peak Pricing (CPP): CPP is one kind of pricing system which is most similar to TOU. Since TOU tariff can not reflect the price change in a small time blocks, therefore, on the basis of TOU, CPP gives a single price when the system is in the critical periods. Through that way, end-users can get the peak signal to minimize their electricity consumption and reduces the peak load as possible as they can. Sometimes, CPP can be applied on top of a regular TOU rate. The example of CPP pricing system was shown in Figure 2-14. Here, the critical peak period is time block from 14:00 to 16:00.
- (5) Peak Time Rebates (PTR): Peak time rebate is a pricing system that customers can receive electricity bill rebates for not using power during peak periods. Actually, it is not the renovation of electricity pricing, instead, it is a method that shift or cut peak load through some incentive actions.
- (6) Real Time Pricing (RTP): Real-time pricing is the most ideal dynamic pricing system compared to others. If the day is divided by hour, the price may vary hourly and is tied to the current load level of the system. RTP can't be known far in advance, and there will not have the same price structure of two different days. Real-time pricing is the purest form of dynamic pricing and the scheme with the maximum uncertainty or risk involved for the consumers. The change in prices in small intervals increases the efficiency of the pricing scheme in reflecting the actual costs of supply. The widely implementation of such pricing schemes require advanced technology to communicate and manage these frequent changes. With the spreading of smart grid, real-time pricing was been anticipated to has a good prospects for development. The example of RTP pricing system was shown in Figure 2-15.

Each of the electricity rates and pricing schemes represents a different combination of risks and rewards for the customer. Figure 2-16 illustrates the reward and risk curve of different pricing systems. It is obvious that TOU offers consumers the least potential reward at lowest risk, owing to that TOU rates don't capture the price variation within a price block. On the contrary, RTP offers consumers potentially the highest reward compared to traditional flat-rate pricing, but also the highest risk. CPP is a pricing system between those two systems.

**CHAPTER TWO: SURVEY ON THE DEVELOPMENT STATUS AND CHALLENGES OF  
SMART GRIDS AND DYNAMIC PRICING  
IN MAIN DRIVER COUNTRIES**

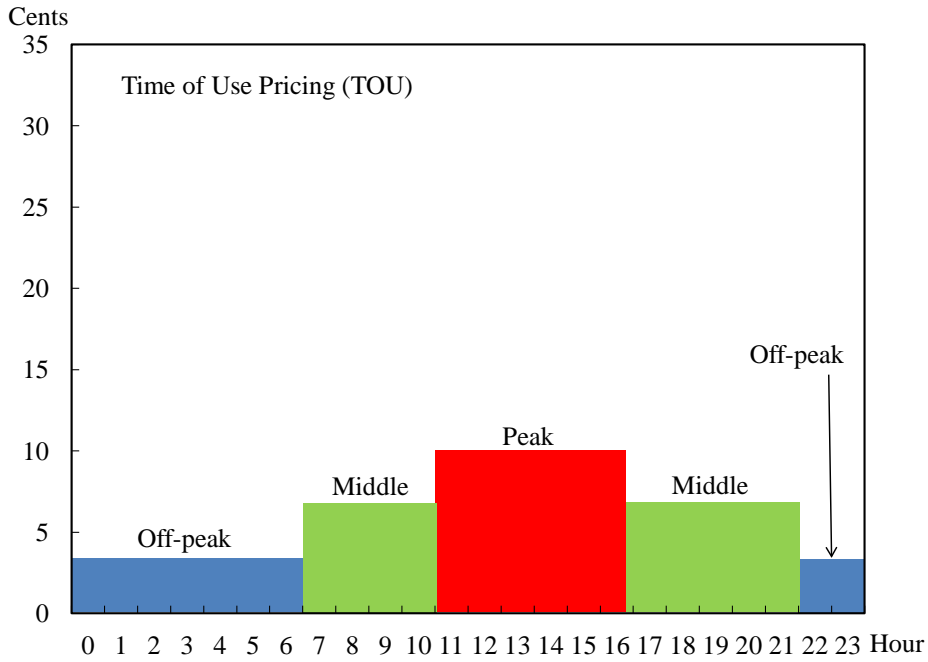

Figure 2-13 TOU pricing system

(Source: Central Research Institute of Electric Power Industry)

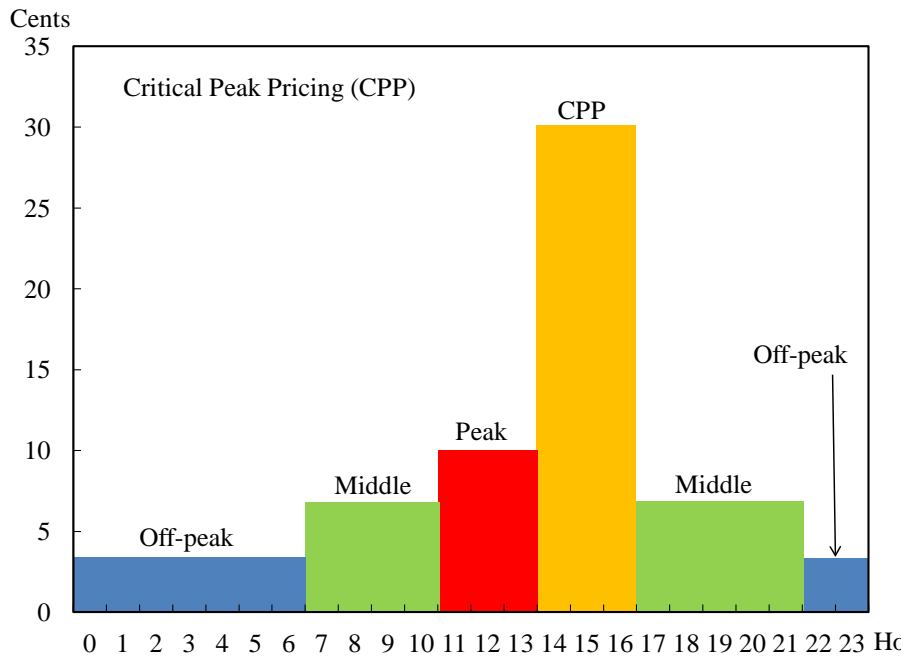

Figure 2-14 CPP pricing system

(Source: Central Research Institute of Electric Power Industry)



**CHAPTER TWO: SURVEY ON THE DEVELOPMENT STATUS AND CHALLENGES OF  
SMART GRIDS AND DYNAMIC PRICING  
IN MAIN DRIVER COUNTRIES**

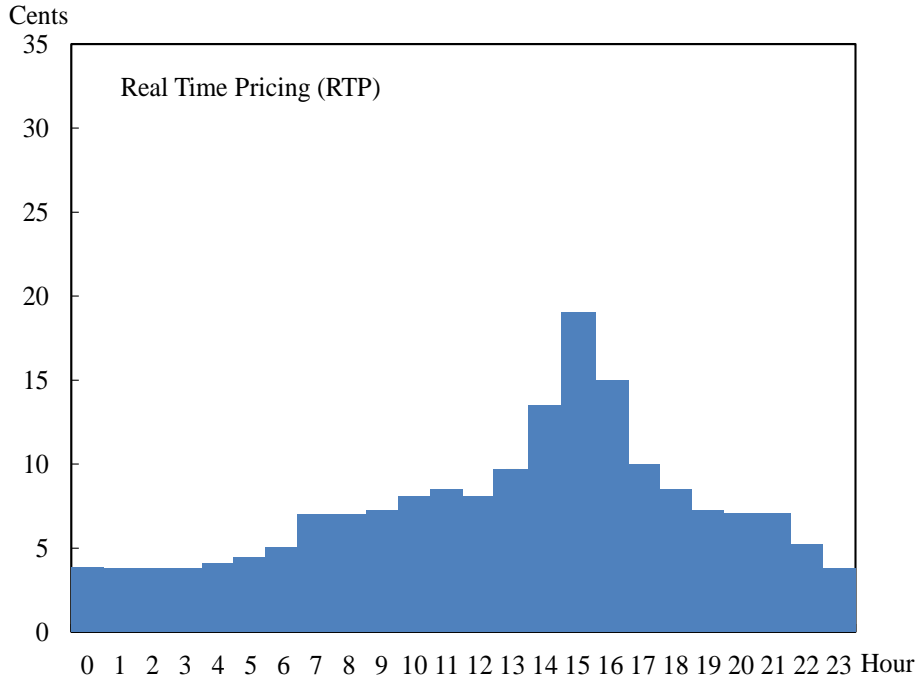

Figure 2-15 RTP pricing system

(Source: Central Research Institute of Electric Power Industry)

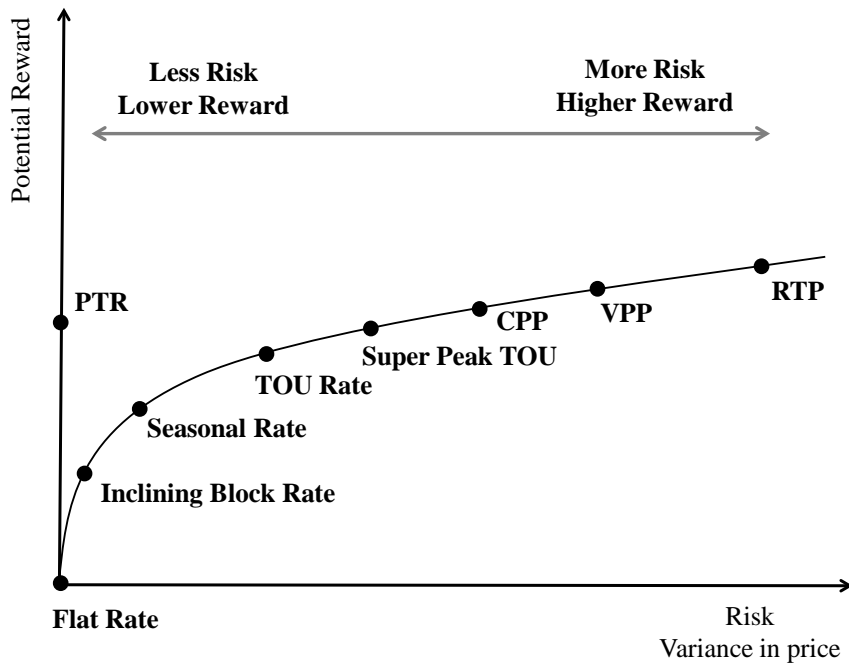

Figure 2-16 Reward and Risk curve of different pricing systems

**CHAPTER TWO: SURVEY ON THE DEVELOPMENT STATUS AND CHALLENGES OF  
SMART GRIDS AND DYNAMIC PRICING  
IN MAIN DRIVER COUNTRIES**

**2.3.3 Development status and achievements of dynamic price**

After the 1970s oil crisis, energy and environmental issues have received increasing attention. Taking this as an opportunity, United States, Japan, Korea and other countries have begun to take implementation of tariff reform. The applicability of pricing reforms of different countries depends on the level of their economic, market development and the stage of their power sector reform. This section will be illustrated as follows.

✧ United States

There are many power companies throughout the United States. When the power utilities supply electricity to end-users, the companies charging mechanism exists some differences, so the American people have faced with different kinds of electricity price.

United States starts to embark on multi-step electricity pricing from the 1970s. The first step of Virginia is 800 kWh, and the price is 2.233 cents per kilowatt-hour for consumers whose electricity consumption is less than 800 kWh. For the middle class of United States, if the first stage is low, the rich people can apply for "extra power", these costs are also charged separately in a stepwise manner (Virginia charged 0.783 cents per kilowatt-hour for the "extra electricity"). Other states have the similar electricity pricing system, but the basic electricity threshold states are different. Besides multi-step electricity price, critical peak price and real time price also been investigated, in order to get a widely use.

Table 2-8 lists the studies relating to the research of dynamic pricing of residential house in United States along with some key study characteristics.

Table 2-8 Studies relating to the research of dynamic pricing in United States

Study name	implementation period	Pilot area
ADRS	July-September in 2004 and 2005	California
Ameren	June-September in 2004 and June-August in 2005	St. Louis, Missouri
GPU	June-September in 1997	New Jersey
Gulf Power	Summer in 2000 and 2001	Western Florida
My power	July in 2006 and September in 2007	Cherry Hill& Hamilton, New Jersey
PG&E	May-October in 2008	Kern Country, California
SPP	July in 2003 and December in 2004	California

Figure 2-17 shows the reported average reduction in peak load for different pilots in United States. Through this figure, we can know that the dynamic pricing in every pilot can help residential consumers cut their peak electricity load. Where, the pilot area which named gulf power can realize the maximum peak load reduction per house, almost reached 2.8 kW.

✧ Japan

Prior to the disaster of the Great East Japan Earthquake and subsequent tsunami in 2010, nuclear

## CHAPTER TWO: SURVEY ON THE DEVELOPMENT STATUS AND CHALLENGES OF SMART GRIDS AND DYNAMIC PRICING IN MAIN DRIVER COUNTRIES

energy power provides the large percentage of Japan's electricity demand, reached to 29%. Where, the shares supplied by fossil fuels and renewable energy sources were, respectively, 62% (liquefied natural gas (LNG), 29%; coal, 25%; oil, 8%) and 10% (hydropower, 9%; other renewable energy, 1%). However, the energy supply structure had changed since the disaster, when nuclear generation accounted for only 1% of total power supply and the share obtained from fossil fuel sources had increased significantly to 88% (LNG, 43%; coal, 30%; oil, 15%), while that from renewable energy remained at 11% (hydropower, 9%; other renewable energy, 2%). The shut-down of nuclear reactors had result in that Japan must restructure its energy systems to achieve sustainable development of power grid. In recent years, renewable energy and demand-side resources have been key issues as Japan attempts to tackle the dilemma of securing its energy supply without further increasing its environmental footprint; these challenges have become particularly acute after the energy crisis. The deployment of electricity dynamic pricing is one essential method to realize this kind of objective.

In FY 2012, the Japanese Ministry of Economy, Trade, and Industry (METI) initiated the Smart Community Pilot Projects in four cities in Japan (Yokohama, Toyota, Kyoto, and Kitakyushu) to explore the impact of advanced metering technologies for electricity. The Japanese government anticipated that the pilot project will brings 17% energy savings compared to the reference case. In terms of demand-side management, one important target is to improve the energy efficiency in consumer side. Most Japanese residential consumers are currently charged flat-rate tariffs for electricity using conventional analog electric meters, however, the Japanese government intends to install digital advanced meters in all households (about 50 million) by 2024. Along with smart meters and possibly home energy management system (HEMS), dynamic pricing schemes, such as critical peak pricing (CPP) and real time pricing (RTP), are expected to induce residential consumers to use electricity more efficiently. In four Smart Community Pilot Projects, Kitakyushu and Kyoto are concentrated on the investigation of dynamic pricing effect. The city of Kitakyushu recruited 182 participants for the experiment and the Kyoto experiment has a larger number of participants which includes 681 customers, 489 of which are non-all-electric customers and 212 of which are all-electric customers. The demonstration projected continued until the spring of 2015, provided many recommendations of the further development of electricity dynamic pricing in Japan.

### ✧ China

In China, the pilot experiment of dynamic pricing which called TOU started from 1980. The pilot was early implemented in Shanghai, Jiangsu and other economically developed eastern provinces. A number of other provinces have gradually extended this measure in the following years. Table 2-9 is the basic information of the use of dynamic price in China. There are five cities in China have been selected, Beijing, Shanghai, Jiangsu, Zhejiang and Guangdong. By the end of 2003, 77,431 consumers representing 61.69 percent of total consumption in Beijing were on TOU prices. The TOU tariff gap between on-peak period and off-peak period is 3.5:1, this lead to about 700 MW peak load was reduced as table 2-2 shown. In 2003, the difference between on-peak and off-peak prices in Shanghai was increased from 3.5:1 to 4:1. As same as Beijing, the peak load reduction effect of Jiangsu is 700MW also. The tariff gap of Zhejiang is 3:1 for larger industrial consumers; 2.6: 1 for normal industrial consumers. Similar to Jiangsu, the tariff gap of Guangdong

**CHAPTER TWO: SURVEY ON THE DEVELOPMENT STATUS AND CHALLENGES OF  
SMART GRIDS AND DYNAMIC PRICING  
IN MAIN DRIVER COUNTRIES**

is 3:1, it can realize 500MW peak load reduction. Among those cities, Shanghai is the first city to implement dynamic pricing in China.

Table 2-9 Basic information of the development of dynamic price in China

City	Tariff gap (on peak/off peak)	Peak load reduction effect	Implementation time
Beijing	3.5:1	700MW	1998
Shanghai	4:1	—	1994
Jiangsu	3:1	700MW	1999
Zhejiang	3:1/ 2.6:1	—	2001
Guangdong	3:1	500MW	2001

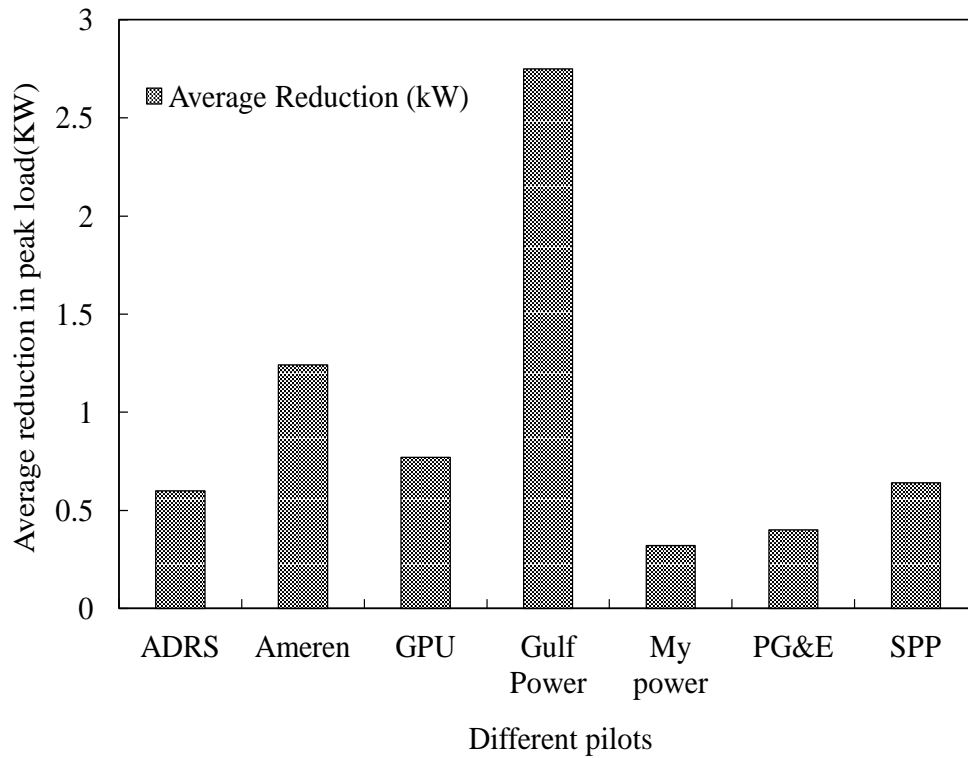

Figure 2-17 Average reduction in peak load for different pilots in United States

## CHAPTER TWO: SURVEY ON THE DEVELOPMENT STATUS AND CHALLENGES OF SMART GRIDS AND DYNAMIC PRICING IN MAIN DRIVER COUNTRIES

### 2.4 Barriers and Challenges of Smart Grids and Dynamic Pricing

Generally, smart grid is a technical prerequisite for many dynamic pricing projects, and dynamic electricity price is one of the best applications of smart grid. Therefore, we just consider the barriers and challenges of smart grids to represent that of dynamic pricing, it can be presented as follows.

#### ✧ Barriers and challenges

In America, there are four main problems facing SG development. First, although the government has fully affirmed the progress of SG development, industry and the public remain skeptical. Industry and the public believed that the development status of the current SG remains slow and that SGs have not achieved what the government promised the public. These promises include realizing two-way communication between users and grids, allowing users manage their own energy production and consumption and providing more employment opportunities for the community. Second, there is a substantial problem in how power and utility companies communicate with users who already installed smart meters. Because America simultaneously promoted new technologies and introduced new electricity tariffs, this variety of factors have led consumers to have a poor understanding of the results of pilot projects. Moreover, high quality and how to interact with customers and persuade them to recognize the value and real benefits of SGs have become important subjects in the continued development of the SG. Third, with the encouragement via financial support provided by the government, SG research and demonstration efforts have seen smooth progress; however, the investment enthusiasm by power companies and other private businesses is not high, which affects the future development of SGs to a certain extent. Fourth, America must strongly invest in SGs to meet the policy requirements for the full deployment of the SG by 2030. However, given present circumstances, it is difficult for America to continue to invest in SGs. Actually, the power asset ownership and management of many American power companies are relatively decentralized, and investments in electrical equipment are very high and follow long life cycles. This results in each power company having to perform a cost-effectiveness analysis before making investment decisions. Therefore, subsequent follow-up funding is difficult to obtain.

In Europe, the situation is similar to America, where the biggest bottleneck in the development of SGs is follow-up funding problems; moreover, it is even more serious than in America. According to estimates by Pike research, the investments in SGs of EU countries will reach 79 billion Euros by 2020. Moreover, due to the impact of the European credit crisis, the speed of and capital investment in Europe SG development continue to face uncertainty. Moreover, the interoperability of Europe SGs is not high. As new applications of SGs are realized, the roles and responsibilities of various stakeholders remain uncertain. A clear cost-benefit-sharing mechanism also remains unclear.

Japan's SG demonstration project realized many achievements and basically met their original targets. However, scaling-up small-scale demonstration projects into large-scale practical applications remains a substantial problem. In addition, although Japan's SG-related technologies, especially battery technology, are world class, America continues to have the power to establish basic SG international standards. Actively participating in and promoting the development of international standards remains a significant challenge to Japan.

In China, the biggest obstacle encountered in SG development is the lack of a clear national

## CHAPTER TWO: SURVEY ON THE DEVELOPMENT STATUS AND CHALLENGES OF SMART GRIDS AND DYNAMIC PRICING IN MAIN DRIVER COUNTRIES

policy and roadmap. Although a series of documents have been issued to facilitate the implementation of SGs, planning and related standards that guide specific actions have not been introduced, making various SG stakeholders feel anxious and confused. In addition, China continues to need to break through technical barriers. Chinese power companies view developing renewable energy resources as an opportunity but face many challenges in certain technical aspects. The traditional Chinese grid is powered by thermal power plants and hydropower plants, and the design of the grid network is expected to remain stable for a long time. However, with the introduction of wind, solar and other clean energy generation types, grid technologies have begun to exhibit various types of issues. Addressing the transition between the old and new grid represents a substantial challenge to China's SG development.

### ◇ Future trends and tendencies

United States and Europe still need to establish and improve relevant laws and regulations for the long-term development of SGs in terms of managing the risks and benefits from the perspective of policy. They must do this while developing technical standards that can be accepted by industry and achieving the integration of different equipment manufactured by different companies. This would encourage the active participation of various private enterprises and power companies while attracting subsequent investment. In addition, strengthening communication with users is also very important and can help SG developers understand the lack of SG process. The development of SGs in Japan should continue to strengthen the links and interaction between the three institutions (government, industry and academic institution) and attempt to create a new method that can help promote SGs while providing new services in line with the needs of users. This would enhance their understanding of SGs, encourage and stimulate the active participation of local residents and local businesses, and finally push the widespread development of SGs. What's more, Japan should continue to concentrate on international cooperation related to SGs, seeking to use its technological advantage to obtain the right to influence international standard-setting. The Chinese government should focus on implementing a reform of the power grid, therein actively improving the infrastructure of the power industry so that it can be coordinated with the development of SGs. In addition, the Chinese government should give strong support to SGs through policy and continue to improve the relevant standards and provide favorable conditions for the development of SGs.

SG is still a relatively new concept despite its great accomplishments achieved. In order to realize the scale-up and industrialization of smart grids, we still need to do great effort. According to the above analysis, SGs development can be improved from three aspects. First is end-user side. Enhancing the feedback of end-users is essential to the process of developing SG. It has the most effective and direct influence on the successful implement of SG. The related technology needs to be constantly upgraded to meet the change of users' motivation. Only in this way, end-users could adapt the technology according to their own needs and expectations. Human habits also need to be investigated seriously which is helpful to the improvement of efficiency and flexibility of energy management system. Besides, users' knowledge of SG plays an important role during the promoting of SG. With the better understanding of SG, end-users can take an active part in SG development. For example, it can help them correctly install and properly configure the smart devices, meanwhile, improving the awareness of energy management. Second is technology side. Simple technology should be explored to coordinate with the consumers, more products and

## **CHAPTER TWO: SURVEY ON THE DEVELOPMENT STATUS AND CHALLENGES OF SMART GRIDS AND DYNAMIC PRICING IN MAIN DRIVER COUNTRIES**

service should be provided to meet the requirement of different stakeholders. The challenge of developing good technology is not only realize the data communication, but also the ability of enabling various roles have the opportunity to continual involving in the adaptation and customization process of SG. Last is the policy side. SGs involve a series of new technologies which have great potential in the future power grid development. To build a secure, economic, clean, transparent and compatible power grid in the future, we should take measures to propel the development of smart grids [10]. In a word, SGs not only is the energy system innovation, but also the institutional innovation. The healthy development of SG is tightly related to clear policy support and unified technical regulations under the background of power marketization. A generally approved standards system is also a key factor for orderly development of SG owing to the complexity of SG which involving many industries and technical areas.

## CHAPTER TWO: SURVEY ON THE DEVELOPMENT STATUS AND CHALLENGES OF SMART GRIDS AND DYNAMIC PRICING IN MAIN DRIVER COUNTRIES

### 2.5 Summary

This chapter compares the development backgrounds and infrastructure status of various countries based on five aspects and presents an overview of the smart grid and the electricity dynamic pricing development situations in the main driver countries, discusses the research results produced by smart grid and electricity dynamic pricing projects in different countries, summarizes their achievements and challenges, and provides a roadmap for national policy makers and power companies through which they can better orientates the development of smart grid and electricity dynamic pricing.

This chapter noting that America and Europe have the most similar development mode for SGs and have already entered into a mature period. The focus of their recent work is on the application of intelligent technologies, therein addressing challenges produced by renewable power integration in the case of possible mitigation investments. Moreover, this paper found that the Japanese model of SG development is a government-led, community-oriented, business-driven approach. They focus on technological innovation. In addition, Japan provides experience in terms of creating a business model for SGs. This paper also demonstrated that China has the most unique SG development structure compared with America, Europe, and Japan. The management of SGs in China is highly centralized, and China has made encouraging progress in ultra-high-voltage transmission systems.

Although each country has made many achievements in the development of SGs, our research also reveals that a common problem that they face is a lack of clear related standards for SGs. For example, the lack of a clear cost-benefit-sharing mechanism makes subsequent investments difficult, and the lack of worldwide technical standards restricts the integration of different equipment manufactured by different companies, both of which hinder the continued development of SGs. Therefore, the three countries and Europe should strengthen their standardization development while sharing experience and putting substantial effort behind forming international standards for SGs. Except the policy and standard side, this paper also concluded the useful recommendations from end-user side and technology side, found that the problem of low participation of end-users during the development of SG exists in every country. This paper proposed that exploring human habits and feedback of end-users is meaningful to improve the efficiency of SGs, the enhancement of users' knowledge of SG is also helpful to it. Co-shape technology with end-users and create simple SG products and services provide another effective way to well develop SG.

Consequently, under the background of economic globalization, the rational choices for the major countries toward developing their SGs are to exchange and cooperate with other countries, develop more mature technologies, present a reasonable market mechanism and business model, establish a generally approved standards system, and remove barriers to the widespread use of SGs. In this way, SGs will achieve good development prospects and contribute greatly to renewable energy development.



## CHAPTER TWO: SURVEY ON THE DEVELOPMENT STATUS AND CHALLENGES OF SMART GRIDS AND DYNAMIC PRICING IN MAIN DRIVER COUNTRIES

### REFERENCE

- [1] Ming Z, Song X, Mingjuan M, Xiaoli Z. New energy bases and sustainable development in China: a review. *Renewable Sustain Energ Rev* 2013;20:169–85.
- [2] Oyedepo SO. On energy for sustainable development in Nigeria. *Renewable Sustain Energ Rev* 2012;16:2583–98.
- [3] Huisingh D, Zhang Z, Moore JC, Qiao Q, Li Q. Recent advances in carbon emissions reduction: policies, technologies, monitoring, assessment and modeling. *J Cleaner Prod* 2015;103:1–12.
- [4] Xuehao H. Smart grid: a development trend of future power grid. *Power Syst Technol* 2009;33:1-5.
- [5] Bompard E, Huang T, Wu Y, Cremenescu M. Classification and trend analysis of threats origins to the security of power systems. *Int J Electr Power Energy Syst* 2013;50:50–64.
- [6] Peng M, Liu L, Jiang C. A review on the economic dispatch and risk management of the large-scale plug-in electric vehicles (PHEVs)-penetrated power systems. *Renewable Sustain Energ Rev* 2012;16:1508–15.
- [7] Mohamed E. El-hawary. The Smart Grid—State-of-the-art and Future Trend. *Electric Power Components and Systems*. 2014, 42: 3-4, 239-250.
- [8] Berger, Lars T.; Iniewski, Krzysztof, eds. *Smart Grid - Applications, Communications and Security*. April 2012.
- [9] Arijun Makhijani. Carbon-free and nuclear-free. *Science for Democratic Action*. August, 2007.
- [10] A. Zahedi, “Developing a System Model for Future Smart Grid,” *Proceedings in 2011 IEEE PES Innovative Smart Grid Technologies Conference, ISGT Asia 2011, Perth, 13-16 November 2011*, pp. 1-5.
- [11] Coll-Mayor, D.; Paget, M.; Lightner, E. Future intelligent power grids: Analysis of the vision in the European Union and the United States. *Energy Policy* 2007, 35, 2453–2465.
- [12] G. M. Shafiullah. *Smart Grid for a Sustainable Future*. *Smart Grid and Renewable Energy*, 2013, 4, 23-34
- [13] Clastres, C. Smart Grids: Another step towards competition, energy security and climate change objectives. *Energy Policy* 2011, 39, 5399–5408.
- [14] Uchechi Obinna. Insights from Stakeholders of Five Residential Smart Grid Pilot Projects in the Netherlands. *Smart Grid and Renewable Energy*, 2016, 7, 1-15
- [15] Mah, D.N.; van der Vleuten, J.M.; Ip, C.J.; Hills, P.R. Governing the transition of socio-technical systems: A case study of the development of smart grids in Korea. *Energy Policy* 2012, 45, 133–141.
- [16] Mohamed E. El-hawary. The Smart Grid—State-of-the-art and Future Trends. *Electric Power Components and Systems*. 2014. 42:3-4, 239-250.
- [17] Zio, E.; Aven, T. Uncertainties in Smart Grids behavior and modeling: What are the risks and vulnerabilities? How to analyze them? *Energy Policy* 2011, 39, 6308–6320.
- [18] World Energy Council. *Smart grids: best practice fundamentals for a modern energy system*; 2012.
- [19] International Energy Agency (IEA). *Smart grid roadmap*; 2011.
- [20] ENTSO-E, EDSO. *The European electricity grid initiative (EEGI) roadmap 2010-18 and*

## CHAPTER TWO: SURVEY ON THE DEVELOPMENT STATUS AND CHALLENGES OF SMART GRIDS AND DYNAMIC PRICING IN MAIN DRIVER COUNTRIES

detailed implementation plan 2010-12; 2010.

[21] EEGI. Roadmap for public consultation; 2010.

[22] International Energy Agency (IEA). Smart grid roadmap.

[23] Yuan J, Shen J, Pan L, Zhao C, Kang J. Smart grids in China. *Renewable Sustain Energy Rev* 2014;37:896–906.

[24] European Renewable Energy Council. Renewable energy technology roadmap: 20% by 2020. Brussels, Belgium; 2008.

[25] Colak I, Fulli G, Sagioglu S, Yesilbudak M, Catalin-Felix C. Smart grid projects in Europe: current status, maturity and future scenarios. *Appl Energy* 2015;152:58–70.

[26] Smart grid projects in Europe: lessons learned and current developments. Joint Research Centre of European Commission; 2012.

[27] Guidelines for conducting a cost-benefit analysis of smart grid projects. Joint Research Centre of European Commission; 2012.

[28] Smart energy grids and complexity science. Joint Research Centre of European Commission; 2012.

[29] The Social dimension of smart grids. Joint Research Centre of European Commission; 2012.

[30] Hamasaki H, Kanudia A. System analysis of Japanese renewable energy. Fujitsu Research Institute; 2014.

[31] Ina H, Umino K, Rudd J, Tokumoto N. Japan approves final set of power market reforms. *Jonesday*; 2015.

[32] Japan Smart Community Alliance. Available at: [www.smart-japan.org/english/index.html](http://www.smart-japan.org/english/index.html).

[33] SGCC. Smart grids development of SGCC during 12th five-year-plan period; 2009.

[34] Yu YX, Luang WJ. Basic philosophy of smart grid. *J Tianjin Univ* 2011;44:377–84.

[35] <http://eur-lex.europa.eu/legal-content/EN/TXT/?qid=1399375464230&uri=CELEX%3A32012L0027>

[36] Claire Dupont. Decarbonization in the European Union, Internal Policies and External Strategies. 2015

[37] International Electrotechnical Commission: [www.iec.ch/smartgrid/background/explained.htm](http://www.iec.ch/smartgrid/background/explained.htm)

[38] Dr. S. Chakrabarti . Smart Grid: Concepts and Deployment. Department of Electrical Engineering IIT Kanpur

[39] European Commission:

<http://ec.europa.eu/energy/en/topics/markets-and-consumers/smart-grids-and-meters>

[40] European Regulators' Group for Electricity and Gas. Annex 3: Evaluation of Responses—ERGEG Conclusions Paper on Smart grids; Technical Report for Council of European Energy Regulators ASBL: Brussels, Belgium, 2009.

[41] Japan Smart Community Alliance: [www.smart-japan.org/english/index.html](http://www.smart-japan.org/english/index.html)

[42] Electricity system development: a focus on smart grids overview of activities and players in smart grids. United Nations Economic Commission for Europe (UNECE)

[43] S. Arndt, T. Sheveleva and C. Goeker. Smart grid terminology development—crossing the boundaries of terminology standardization. *Energy, Sustainability and Society* 2015; 5:20;

[44] YanShan Yu, Jin Yang and Bin Chen. The Smart Grids in China- A Review. *Energies* 2012, 5, 1321-1338.

[45] 61970-301 Ed. 1: Energy management system application program interface (EMS-API) -

## CHAPTER TWO: SURVEY ON THE DEVELOPMENT STATUS AND CHALLENGES OF SMART GRIDS AND DYNAMIC PRICING IN MAIN DRIVER COUNTRIES

- Part 301: Common information model (CIM) base, IEC Std., 2007.
- [46] 60870 Ed.2: Telecontrol equipment and systems - Part 5-101: Transmission protocols - Companion standard for basic telecontrol tasks, IEC Std., 2003.
- [47] 62351-1 TS Ed.1: Data and communication security - Part 1: Introduction and overview, IEC Std., 2006.
- [48] 62357 Second Edition: TC 57 Architecture - Part 1: Reference Architecture for TC 57 - Draft, IEC Std., 2009.
- [49] CENELEC, “Smart Meters Coordination Group: Report of the Second Meeting held on 2009-09-28 and Approval of SM-CG Work Program for EC Submission”, 2009.
- [50] “Japans Roadmap to International Standardization for Smart Grid and Collaborations with other Countries”, 2010.
- [51] IEEE, “P2030 Draft Guide for Smart Grid Interoperability of Energy Technology and Information Technology Operation with the Electric Power System (EPS)”, 2009.
- [52] Mathias Uslar, Sebastian Rohjans, Robert Bleiker, Jos´e Gonz´alez, Michael Specht, Thomas Suding and Tobias Weidelt. Survey of Smart Grid Standardization Studies and Recommendations. IEEE. 11, 2010
- [53] Morozumi S. On-going smart grid implementations and pilots in Japan. New Energy and Industrial Technology Development Organization.
- [54] Yuan J, Hu Z. Low carbon electricity development in China – an IRSP perspective based on super Smart Grid. *Renewable Sustain Energ Rev* 2011;15:2707–13.
- [55] Tan W, He G, Liu F, Huang W, Deng Z, Deng Y. A preliminary investigation on smart grid's low-carbon index system. *Autom Electr Power Syst* 2010;34:1–5.
- [56] New Energy and Industrial Technology Development Organization (NEDO). Current status and future prospects of the smart community; 2012. Available at: <http://www.nedo.go.jp>.
- [57] State Council of China. The 12th five-year-plan for national economy and social development; 2011.
- [58] Newsham GR, Bowker BG. The effect of utility time-varying pricing and load control strategies on residential summer peak electricity use: a review. *Energ Policy* 2010;38:3289–96.
- [59] EC JRC, US DOE. Assessing smart grid benefits and impacts: EU and US initiatives; 2012.
- [60] National Institute of Standards and Technology (NIST). NIST framework and roadmap for Smart Grid interoperability standards. release 1.0; 2010.
- [61] SGIP smart grid interoperability panel. The Gridwise Architecture Council (GWAC) Stack.
- [62] Sun Q, Ge X, Liu L, Xu X, Zhang Y, Niu R et al. Review of smart grid comprehensive assessment systems. *Energ Procedia* 2011;12:219–29.
- [63] Evaluation of Critical and Emerging Security Technologies for the Elaboration of a Strategic Research Agenda.
- [64] Colak L, Sagioglu S, Fulli G, Yesilbudak M, Covrig C. A survey on the critical issues in smart grid technologies. *Renewable Sustain Energ Rev* 2016;54:396–405.
- [65] Luthra S, Kumar S, Kharb R, Ansari F, Shimmi SL. Adoption of smart grid technologies: an analysis of interactions among barriers. *Renewable Sustain Energ Rev* 2014;33:554–65.
- [66] Arif SM, Bouzguend M. Effects of smart grid technologies on capacity and energy savings – A case study of Oman. *Energ* 2013;54:365–71.
- [67] Zahurul S, Mariun N, Grozescu IV, Tsuyoshi H, Mitani Y, Othman ML et al. Future strategic

## CHAPTER TWO: SURVEY ON THE DEVELOPMENT STATUS AND CHALLENGES OF SMART GRIDS AND DYNAMIC PRICING IN MAIN DRIVER COUNTRIES

plan analysis for integrating distributed renewable generation to smart grid through wireless sensor network: Malaysia prospect. *Renewable Sustain Energ Rev* 2016;53:978–92.

[68] Di Santo KG, Kanashiro E, Di Santo SG, Saidel MA. A review on smart grids and experiences in Brazil. *Renewable Sustain Energ Rev* 2015;52:1072–82.

[69] Haidar AMA, Muttaqi K, Sutanto D. Smart Grid and its future perspectives in Australia. *Renewable Sustain Energ Rev* 2015;51:1375–89.

[70] Thakur J, Chakraborty B. Intelli-grid: moving towards automation of electric grid in India. *Renewable Sustain Energ Rev* 2015;42:16–25.

[71] New Energy and Industrial Technology Development Organization (NEDO). Current status and roadmap for Smart Grid technology.

[72] Energy Independence and Security Act (EISA) 2007.

[73] U.S Department of Energy. American Recovery and Reinvestment Act of 2009: Smart Grid Investment Grant Program (SGIG) progress report.

[74] European Economic Recovery Plan 2008.

[75] Third legislative for further liberalization of the electricity and gas markets; 2009.

[76] European Council summits 2010.

[77] Policy Package to Address the Economic Crisis.

[78] Report of the next-generation power transmission and distribution network.

[79] Basic Energy Plan.

[80] Fourth Basic Energy Plan.

[81] NDRC. Renewable energy pricing and cost-sharing (pilot management scheme); 2006.

[82] State Electricity Regulatory Commission (SERC). Management measures on auxiliary service in power system; 2006.

[83] National People's Congress of China (NPC). Renewable energy law (amendment); 2009.

[55,84] MOST. Twelfth five plan related to major science and technology industrialization projects of Smart Grid.

[85] MOF. Financial subsidy for distributed PV project; 2013.

[86] Giordano V, Gangale F, Fulli G, Sánchez Jiménez M. Smart grid projects in Europe: lessons learned and current developments. JRC Reference Reports; 2011.

[87] Top Markets Report Smart Grid. U.S. Department of Commerce, International Trade Administration, Industry & Analysis (I&A); 2015.

[88] Pike Research. Smart Grids in Europe, Pike Research Clean Tech Market Intelligence; 2011.

[89] Electric Power Research Institute (EPRI). Estimating the costs and benefits of the smart grid - a preliminary estimate of the investment requirements and the resultant benefits of a fully functioning smart grid; 2011.

[90] Zypyme Research & Consulting, China. Rise of the Smart Grid, Special report by Zypyme's Smart Grid Insights.

[91] SmartGridnews.com. Smart grid snapshot: China tops stimulus funding. SmartGridNews.com; 2010.

[92] Smartmeters.com. Smart meters deployment looks strong for 2011; 2011.

[93]<http://www.metering.com/smart-meters-japan-utilities-to-accelerate-residential-rollouts/>.

[94] Innovation Observatory. Smart grid technology investment: forecast for 2010-2030; 2011.

[96] U.S. Department of Energy Office of Electricity Delivery and Energy Reliability. Smart Grid

## CHAPTER TWO: SURVEY ON THE DEVELOPMENT STATUS AND CHALLENGES OF SMART GRIDS AND DYNAMIC PRICING IN MAIN DRIVER COUNTRIES

investment Grant Program (SGIG) Update. February 2013.

[97] Giordano V, Meletiou A, Covrig CF, Mengolini A, Ardelean M et al. Smart Grid projects in Europe: lessons learned and current developments. JRC scientific and policy report; 2013.

[98] Zhang Y, Ding C, Min Y, Jiang X, Fan M, Zhang Z. Development and experiences of smart grid projects in Europe. Power Syst Technol 2014;38.

[99] Giordano V, Bossart S. Assessing Smart Grid benefits and impacts: EU and US Initiatives. Joint report of the EC JRC and US DOE.

[100] Yun KL. A study of cooperation networks and new business in the smart grid. J Cent. Reg. Aff. Fukushima Univ. 9, 2012.

[101] Covrig CF, Ardelean M, Vasiljevska J, Mengolini A, Fulli G, Amoiralis E. Smart Grid Projects Outlook 2014. JRC Scientific and Policy Report.

[102] Smart grid information clearinghouse.

[103] NIST special publication 1108. NIST framework and roadmap for smart grid interoperability standards, Release 1.0; 2010.

[104] NIST special publication 1108R2. NIST framework and roadmap for smart grid interoperability standards, Release 2.0; 2012.

[105] Catalog of Standards. Available at: <http://sgip.org/Catalog-of-Standards>.

[106] CEN/CENELEC/ETSI Joint Working Group on standards for Smart Grids. New ETSI-CEN-CENELEC approach for rapid SG deployments; 2014.

[107] CEN-CENELEC-ETSI Smart Grid Coordination Group. CEN-CENELEC-ETSI Smart Grid Coordination Group framework document; 2012.

File:///C:/Users/ZhangYao/Downloads/Smart%20Grids%20Framework%20Document.pdf.

[108] Takeshi S, Yasuro S, Yoshihiro OHBA. Special reports: trends in international standardization of smart grids and Toshiba's approach; 2013.

[109] State Grid Corporation of China. Framework and roadmap for strong & smart grid; 2012.

[110] CEN/CENELEC/ETSI JWG. Report on standards for smart grid V1.0.

[111] CEN/CENELEC/ETSI Joint Presidents Group. Final report of the CEN/CENELEC/ETSI Joint Working Group on Standards for Smart Grids; 2011.

[112] Takanori Ida, Kayo Murakami, Makoto Tanaka, Electricity demand response in Japan: Experimental evidence from a residential photovoltaic generation system. Research Project Center. August, 2015



## **CHAPTER THREE: EXPLORATORY ANALYSIS OF KITAKYUSHU RESIDENTS RESPONSE TO DYNAMIC ELECTRICITY PRICING**

### 3.1 Introduction

### 3.2 Database of Residents in Kitakyushu Smart Community Project

#### 3.2.1 Basic information of the project

#### 3.2.2 Information of resident group in the project

#### 3.2.3 Electricity pricing system of residents in the project

### 3.3 Energy Consumption of the Target Residential House

#### 3.3.1 The yearly electricity consumption

#### 3.3.2 The monthly electricity consumption

#### 3.3.3 The hourly electricity consumption

### 3.4 Evaluation of Residents Response to Dynamic Electricity Pricing

#### 3.4.1 Dynamic electricity pricing effect influenced by temperature

#### 3.4.2 Dynamic electricity pricing effect influenced by floor area

#### 3.4.3 Dynamic electricity pricing effect influenced by price level

#### 3.4.4 Dynamic electricity pricing effect influenced by consciousness

### 3.5 Summary





## CHAPTER THREE: EXPLORATORY ANALYSIS OF KITAKYUSHU RESIDENTS RESPONSE TO DYNAMIC ELECTRICITY PRICING

### 3.1 Introduction

In Japan, especially due to the shutdown of nuclear power plants after the great disaster, the energy structure has been dramatically changed. The nuclear share in domestic electricity production has seriously decreased and the percentage of fossil fuels has been increasing as a substitute for nuclear power. The replacement fuel costs of thermal generation are estimated to increase from fiscal year (FY) 2010 3.1 trillion Yen to FY2012 3.6 trillion Yen, respectively [1]. CO<sub>2</sub> emission in FY2012 increased by 84 million tons compared with FY2010. Meanwhile, the Japan's electricity rate (model rate for a typical household) is higher by 20% on average compared to that before the earthquake, due to the rate revisions and the rising prices of fuel. In the other hand, the energy consumption of the residential & commercial sector has increased 2.4 times during 1973 to 2012, the highest increase compared to transportation (1.8 times) and industrial sector (0.8 times) [2].

As a result, the government has been working to construct energy policies aiming to provide a stable energy supply and lower energy costs and consumptions. In this process, the big expectations in Japanese energy policy are rising, such as increasing renewable energy, promoting electricity system reform, introducing electric vehicles. Against this background, the construction of the smart grid in Japan has promoted rapidly. It is a wider range action that involves urban development, energy use and IT technologies [3] (including the efficient use of energy, utilization of heat and unused energy sources, improvement of local transportation systems and transformation of the everyday lives of citizens). To international context, smart grid is currently operating in a range of Western countries, what's more, a large amount of pilot experiments which relating dynamic electricity pricing has also been put into practice. Many previous studies already concentrated on the research of the dynamic pricing in those countries. However, there is a little information about the dynamic electricity pricing in Japan.

Therefore, the purpose of this chapter is to introduce the characteristic of Japanese dynamic pricing (DP) model, meanwhile, summarizes the results from an exploratory analysis of about 200 households that took part in DP experiment in Kitakyushu, Japan. Through using hourly load data collected from smart meter, calculates the energy consumption of target residential consumers and estimates statistically load reduction for participants during the DP time block. In addition, this chapter also discusses dynamic electricity pricing effect influenced by various factors, such as temperature, floor area of households, price level and residential consciousness.

### 3.2 Database of smart community project in Kitakyushu

According to the definition provided by the Japan Smart Community Alliance (JSCA), smart community (SC) is a next-generation social system that adds richness to energy and community. It is not consisted of a single technology but is an aggregate of systems where enable various stakeholders make active efforts for the development of their living environment. Moreover, it establishes a new way to reduce CO<sub>2</sub> emissions through large amounts of renewable and highly efficient energy usage. Figure 3-1 shows the basic concept of SC.

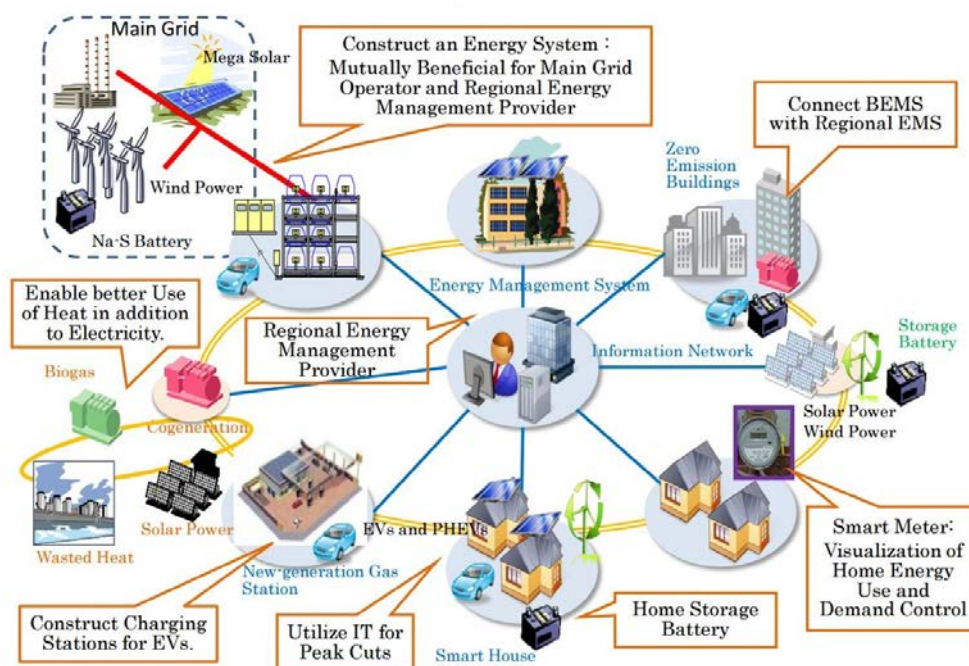

Figure 3-1 Basic concept of smart community [4]

The Japanese model of developing SC is characterized by its government led, community-based and business-driven approach. The detailed information of SC organization system can be concluded in figure 3-2. In this process, Japanese government only responsible for the policy regulation and create good business environment. The main promoter of SC is New Energy and Industrial Technology Development Organization (NEDO) which is an independent administrative agency founded in 1980. In order to further encourage the development of SC, the Japan Smart Community Alliance (JSCA) was established to accumulate knowledge and create multiple collaborations between the public and private sectors. There were 504 members of JSCA as of November 2010.

Figure 3-3 illustrated the road map of SC in Japan. The mean policies and targets for the Japanese SC development can be divided into three stages covering from the building level to the district level. As for the district level, it pays attention to pushing forward the allocation of renewable energy (storage battery, PV), which including the establishment of two-way communication energy supply system between utility grid and EMS (energy management system). For the housing aspect, the policies shed light on the developing on the smart meters and the EV (electric vehicles). For the building aspect, it mainly aimed to realizing the ZEB (Zero emission building).

CHAPTER THREE: EXPLORATORY ANALYSIS OF KITAKYUSHU RESIDENTS  
RESPONSE TO DYNAMIC ELECTRICITY PRICING

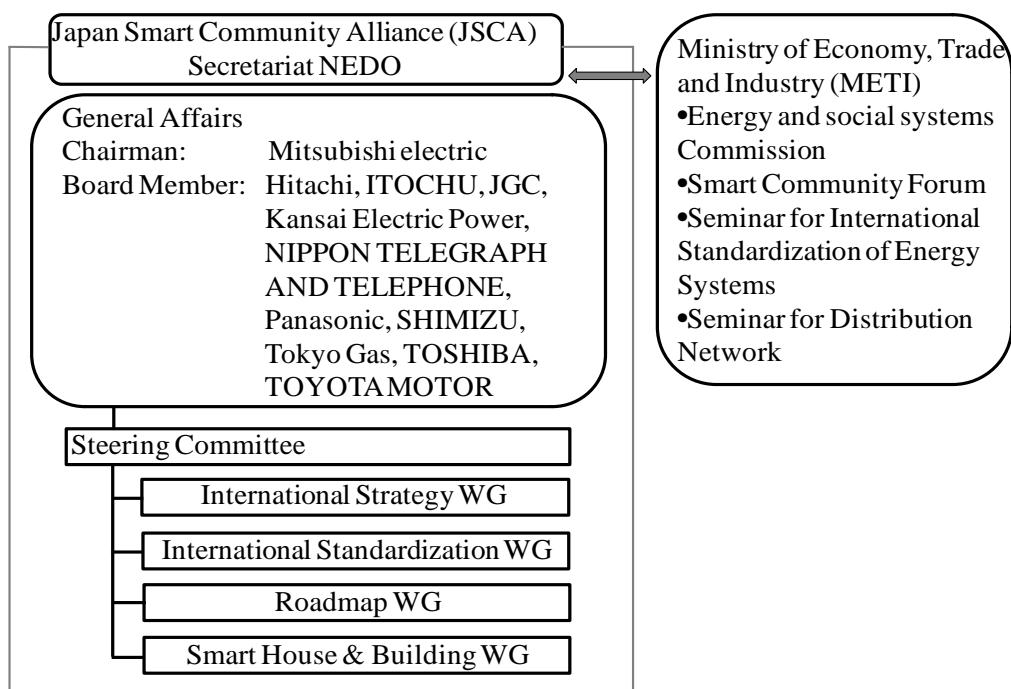

Figure 3-2 Organization System of Japan SC

	Today – Year 2020	2020 –2030	2030 –
Relation between regional EMS and entire grid	<ul style="list-style-type: none"> <li>■ Solar panel prices will decrease due to large-scale introduction of panels to houses and commercial buildings</li> <li>■ Measures to maintain the quality of electricity</li> <li>■ Storage cells will be installed at substations.</li> <li>■ Technology and knowhow will be accumulated.</li> <li>■ The cost of storage cells will go down</li> </ul>	<ul style="list-style-type: none"> <li>■ More PV systems will be installed at houses.</li> <li>■ Regional EMS will become more important.</li> <li>■ Regional EMS will be realized as storage cells become cheaper and are further disseminated.</li> <li>■ Distribution and transmission networks that enable two-way communication will be actively established.</li> </ul>	<ul style="list-style-type: none"> <li>■ Cost competitiveness of RE will improve</li> <li>■ EMS that can provide an optimized balance in terms of economy and security between regional EMS and grid</li> <li>■ EMS will charge EVs and can supply back to the grid as regional cooperation</li> </ul>
Houses	<ul style="list-style-type: none"> <li>■ Remote reading using smart meters will start.</li> <li>■ HEMS will be disseminated.</li> <li>■ Demonstration of EVs will start.</li> </ul>	<ul style="list-style-type: none"> <li>■ HEMS and regional EMS will be integrated.</li> <li>■ Home servers services will be disseminated.</li> <li>■ EVs used for power storage</li> </ul>	<ul style="list-style-type: none"> <li>■ A fully-automated HEMS will be realized.</li> </ul>
Buildings	<ul style="list-style-type: none"> <li>■ ZEB introduction will start. ZEB: Zero Emission Building</li> </ul>	<ul style="list-style-type: none"> <li>■ ZEB will be realized at new public buildings.</li> </ul>	<ul style="list-style-type: none"> <li>■ ZEB will lead to a greatly emissions reduction</li> </ul>

Figure 3-3 Road Map of Japan SC [5]

## CHAPTER THREE: EXPLORATORY ANALYSIS OF KITAKYUSHU RESIDENTS RESPONSE TO DYNAMIC ELECTRICITY PRICING

### 3.2.1 Basic information of the project

The Kitakyushu Smart Community Creation Project illustrates the ideal situation of the development of regional energy management systems, meanwhile, tries to build a low-carbon society through changing lifestyle, business style and city planning policies. By setting up and operating a management base unit called "regional power saving station", it aims to establish a two-way communication mechanism that both citizens and business operators are able to participate in the energy distribution process. In addition, visualization of energy will also realizes a great breakthrough.

This project covers the Higashida area (about 120 ha) in Yahata Ward, Kitakyushu City. The Higashida district is the birthplace of Japan modern industry where had built the Yawata Steel Works which started operation in 1901 and the thermal power plant. It invested about 65 billion yen and redeveloped over 120 billion hectares of factory sites. Higashida area also attracts homes and businesses as well as aeon malls, hospitals, museums, etc. Currently, this area has about 6000 employees and about 900 residents, 210 enterprises (including organizations) are in operation.

Figure 3-4 shows the location of project area. It is the demonstration area which focuses on creating an environment-friendly and energy saving district. The objective of this project is to realize 20% energy saving effect and reduce 50% CO<sub>2</sub> emissions which compared to other typical block in the city. Most consumers who lived in there installs smart management devices, meanwhile, play the dual role of residents and workers. Different from the conventional city block, the citizens who lived there can proactively participate in energy system; they can manage the energy use themselves to a certain extent. Fig 3-5 shows the related facilities of the project. Table 3-1 shows the outline of the Kitakyushu Smart Community Creation Project.

In this creation project, the government aims to realize the energy saving effect through the following ways: the expansion of introduction of renewable energy; efficient use of energy with the installation of CEMS; setting regional power savings stations and improvement of social system such as transportation system. Furthermore, the project also wishes to enhance Japan's competitiveness of the environmental energy industry by developing the communication net of related technologies between Japan and overseas, promoting the cooperation of related industries and the establishment of international standardization.

In addition, this demonstration district is a specific supply area that its electricity was provided by a private line that comes from a cogeneration facility owned by Yawata Steel Works. One of its features is that with the cooperation of the electric power supply and demand association of the Kitakyushu Higashida area, the actual power contract and the electricity price can be changed.

**CHAPTER THREE: EXPLORATORY ANALYSIS OF KITAKYUSHU RESIDENTS  
RESPONSE TO DYNAMIC ELECTRICITY PRICING**

Table 3-1 Outline of the Kitakyushu Smart Community Creation Project

Source: New Energy and Industrial Technology Development Organization

Items	Contents
City	Kitakyushu
Area	448.78 km <sup>2</sup>
Population	971924 (by August 2012 )
Name of pilot experiment	Yahata Higashida District
Area of pilot experiment	1.2 km <sup>2</sup>
Household number of pilot experiment	225
Office number of pilot experiment	50
Smart meter number of pilot experiment	225
	Storage battery: about 800kw
Introduction amount of renewable energy	Solar power generation (PV) : about400kw Fuel cell: about 110kw
Project Theme	Solar, wind, thermal energy, hydrogen, CEMS, BEMS, HEMS, EV, data center, network

CHAPTER THREE: EXPLORATORY ANALYSIS OF KITAKYUSHU RESIDENTS  
RESPONSE TO DYNAMIC ELECTRICITY PRICING



Figure 3-4 Location of the Higashida District, Yahatanishi Ward [6]



Figure 3-5 Related Facilities of Kitakyushu Smart Community Creation Project [6]

## CHAPTER THREE: EXPLORATORY ANALYSIS OF KITAKYUSHU RESIDENTS RESPONSE TO DYNAMIC ELECTRICITY PRICING

### 3.2.2 Information of residents group of the project

The research target is the households who living in Higashida Smart Community's apartment. Figure 3-6 shows the structure of these residential houses. In order to investigate the performance of dynamic pricing on electricity consumption in residential houses, it's been divided into two groups. As shown in table 3-2, group AB is treatment group, it equipped with dynamic electricity pricing. C is control group, it just rely on residents' incentive, without the introduction of dynamic electricity pricing. In addition, AB group has about 120 households, and C group have about 70 households. Smart meters have been installed in all households to collect and transmit information. Residents also can use it to know their own real time electricity consumption.



Figure 3-6 The Higashida residential houses

Table 3-2 Information of Groups

Group		Households	Participating Households	Property
Treatment Group	Group AB	About 120	111	with DP
Control Group	Group C	About 70	66	without DP

The following section is the introduction of basic properties of 190 target households. All related data comes from the questionnaire which made by Kitakyushu City. Table 3-3 displays the survey items of the questionnaire, including house attributes (room number and floor area), household attributes (family size, occupation, income and education background) and household appliances (air conditioner, TV, refrigerator, washing machine, IH cooking heater, dishwasher, household storage battery and EcoCute).

Table 3-4 shows the participate situation of treatment group. The total number of households of treatment group is 120. And the number of participate rate is 91.2%. However, remove the

**CHAPTER THREE: EXPLORATORY ANALYSIS OF KITAKYUSHU RESIDENTS  
RESPONSE TO DYNAMIC ELECTRICITY PRICING**

mismatch and the missing noted questionnaire, the effective response rate of the questionnaire is 92.5%.

Table 3-5 shows the participate situation of control group. The total number of households of control group is 70. And the number of participate rate is 94.3%. Removing the mismatch and the missing noted questionnaire, the effective response rate of the questionnaire is 98.5%.

Table 3-3 Survey Items of the Questionnaire

Survey items	Survey contents
House attributes	Room Number Floor area
Household attributes	Family size Occupation Family income Education background
Household appliances	Number of electric equipments owned (Including air conditioner, TV, refrigerator, washing machine, dryer, IH cooking heater, dishwasher, household storage battery, EcoCute)

Table 3-4 Participate Situation of Treatment Group

Items	Contents
Total Number	120
Participants Number	113
Participation Rate	91.2%
Effective Number	110
Effective Rate	92.5%

Table 3-5 Participate Situation of Control Group

Items	Contents
Total Number	70
Participants Number	66
Participation Rate	94.3%
Effective Number	65
Effective Rate	98.5%

According to the effective questionnaire, we can get the detailed information of basic properties of 190 target households.



## CHAPTER THREE: EXPLORATORY ANALYSIS OF KITAKYUSHU RESIDENTS RESPONSE TO DYNAMIC ELECTRICITY PRICING

### ◇ Floor area information

Figure 3-2 shows the percentage of household across different area in two groups. The area of selected households changes from 60 to 150 square meters. For the sake of simple comparison among three groups, it been divided into five grades.

In the AB group, the floor area of households is over 80 square meters, accounting for 88% of the total. Among them, the proportion of 80 to 90 square meters and 100 square meters or more is almost the same, and each accounts for 32% and 33% of the total, respectively. In the C group, the floor area distribution of households is similar to that of AB group, the area that more than 80 square meters, accounting for 79% of the total. Among them, over 100 square meters is the most common, accounting for 32% of the total. The next largest one is 80 to 90 square meters, accounting for 25% of the total. As for both two groups, the area located in the range of 60 to 70 is minimal, less than 10%.

### ◇ Family size information

Figure 3-8 is the percentage of households in two groups across different family size. It is obvious that the family size of three has the highest number among five different grades. According to the questionnaire of Kitakyushu city, the member of this kind of family composed of mother, father and child. Among the family size of three, AB group has taken the higher proportion, reached to 36%. In addition, a family of two or four is also very common in three groups, takes the half percentage. Family size of one was almost single staff, compared with group AB, C group has a little higher proportion. In addition, family size of 5 account for minimal proportion.

### ◇ Occupation information

Figure 3-9 is the occupation information of two groups. The grade that residents worked in company (employee) has the highest number among five different occupations. Of which, AB group takes 75%, C group takes 63%. As for other four grades (manager, official, unemployed, others), two groups each accounted for about 10%.

### ◇ Year income information

Figure 3-10 shows the year income information of two groups. In the AB group, household with annual income of 5 million or more account for 69% of the total. According to the result of statistical survey of the actual salary survey, it is higher than the average salary per capita of Japan. In group C, households whose annual salary is 5 million or more account for 65% of the total.

### ◇ Education information

Figure 3-11 shows the education information of two groups. In the AB group, the households with university graduates accounts for the majority, almost reached to 40%, followed by high school graduation, accounting for 37% of the total. The education information of group C is almost similar with group AB.

### ◇ Household appliances information

Figure 3-12 and 3-13 is the household appliance information of two groups. It is obvious that a little part of households have dishwashers and dryers. Many households have one washing machine and one refrigerator. Some households have more than two refrigerators, two to five televisions, and households that have two or more air conditioners account for 84% of the total. The household appliance information of group C is almost similar with group AB.

CHAPTER THREE: EXPLORATORY ANALYSIS OF KITAKYUSHU RESIDENTS  
RESPONSE TO DYNAMIC ELECTRICITY PRICING

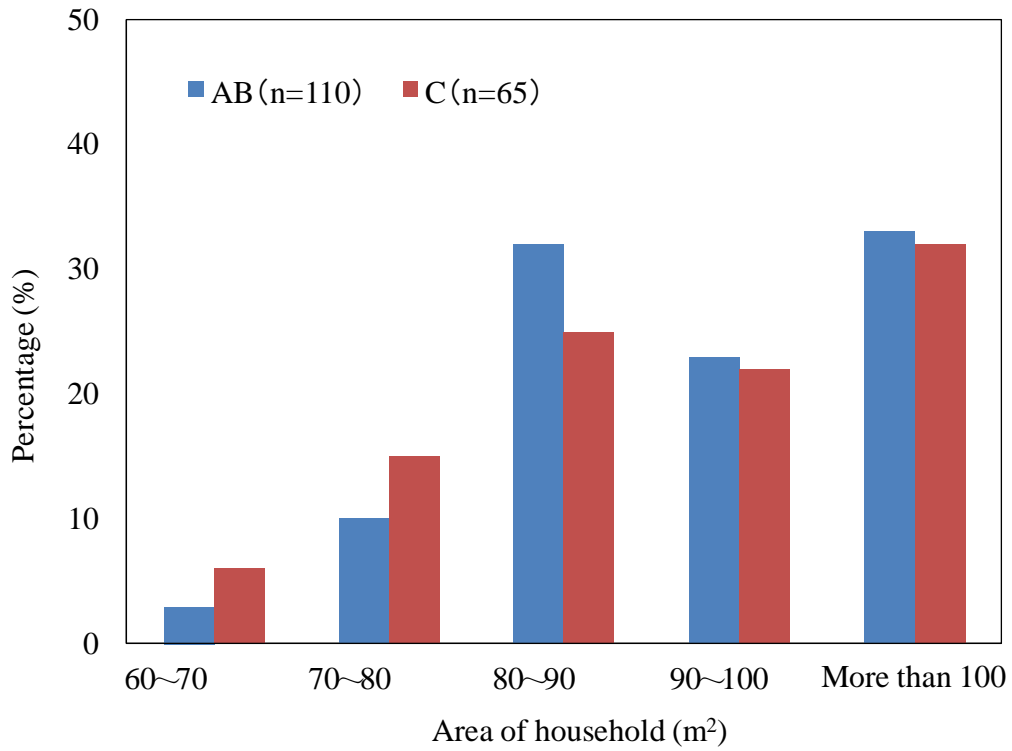

Figure 3-7 Percentage of household across different area

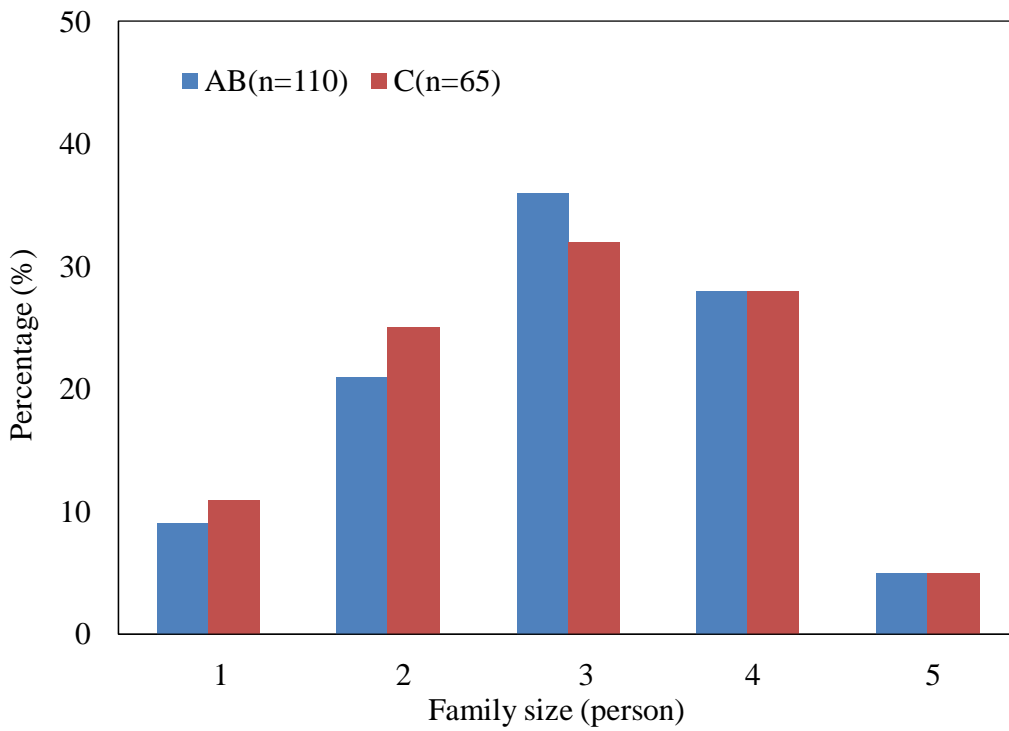

Figure 3-8 Percentage of household across different family size

CHAPTER THREE: EXPLORATORY ANALYSIS OF KITAKYUSHU RESIDENTS  
RESPONSE TO DYNAMIC ELECTRICITY PRICING

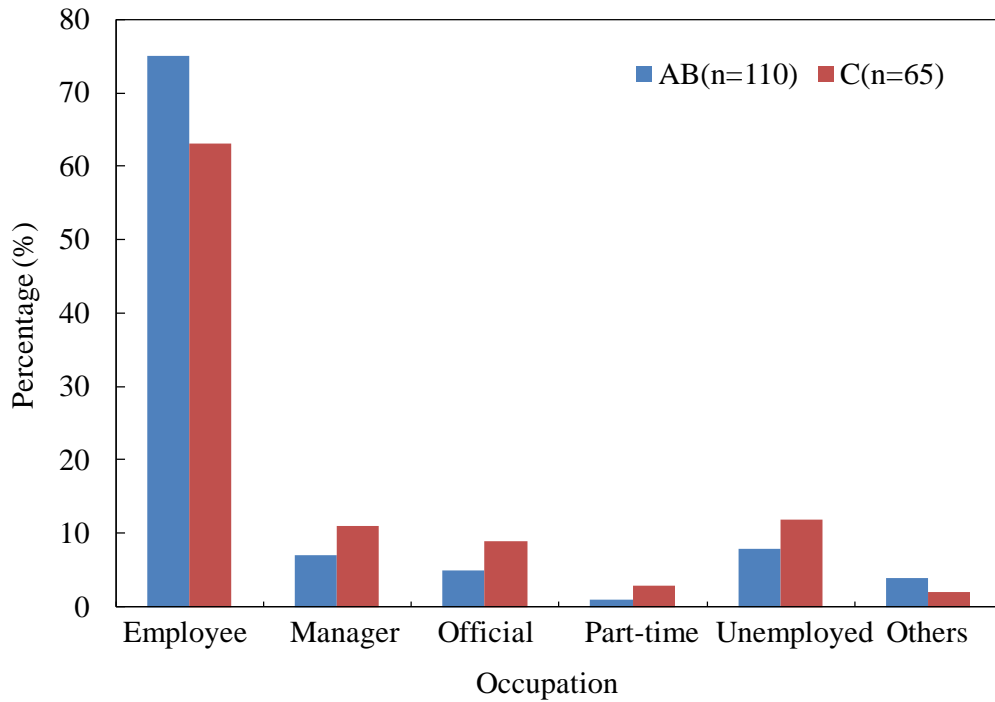

Figure 3-9 Percentage of household across different occupation

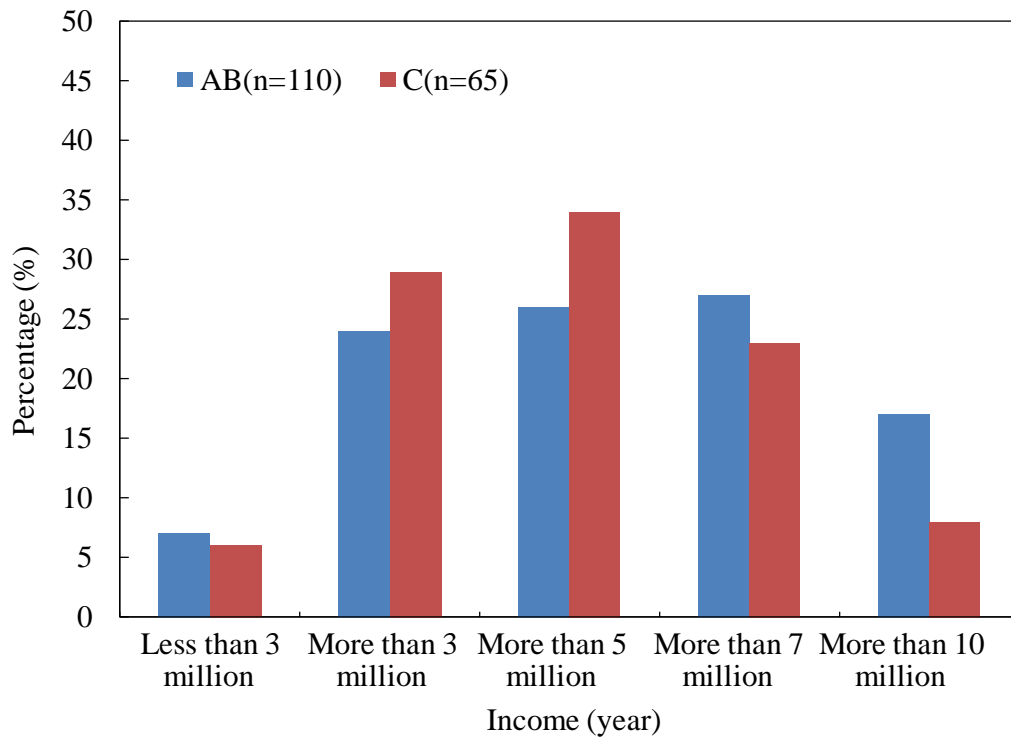

Figure 3-10 Income information of household

CHAPTER THREE: EXPLORATORY ANALYSIS OF KITAKYUSHU RESIDENTS  
RESPONSE TO DYNAMIC ELECTRICITY PRICING

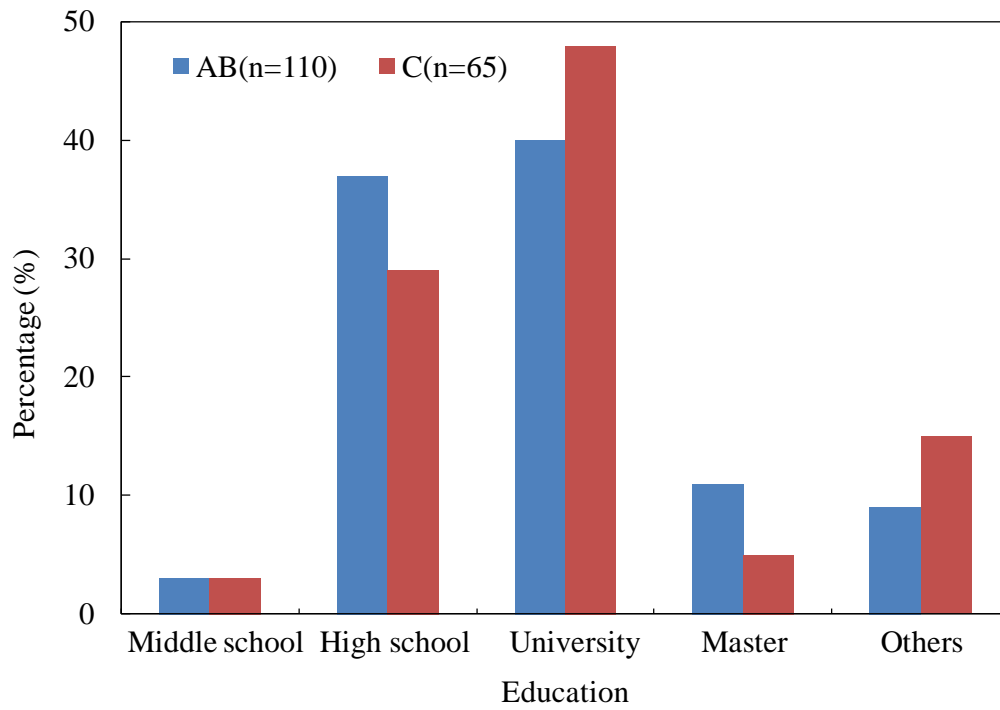

Figure 3-11 Education information of household

CHAPTER THREE: EXPLORATORY ANALYSIS OF KITAKYUSHU RESIDENTS  
RESPONSE TO DYNAMIC ELECTRICITY PRICING

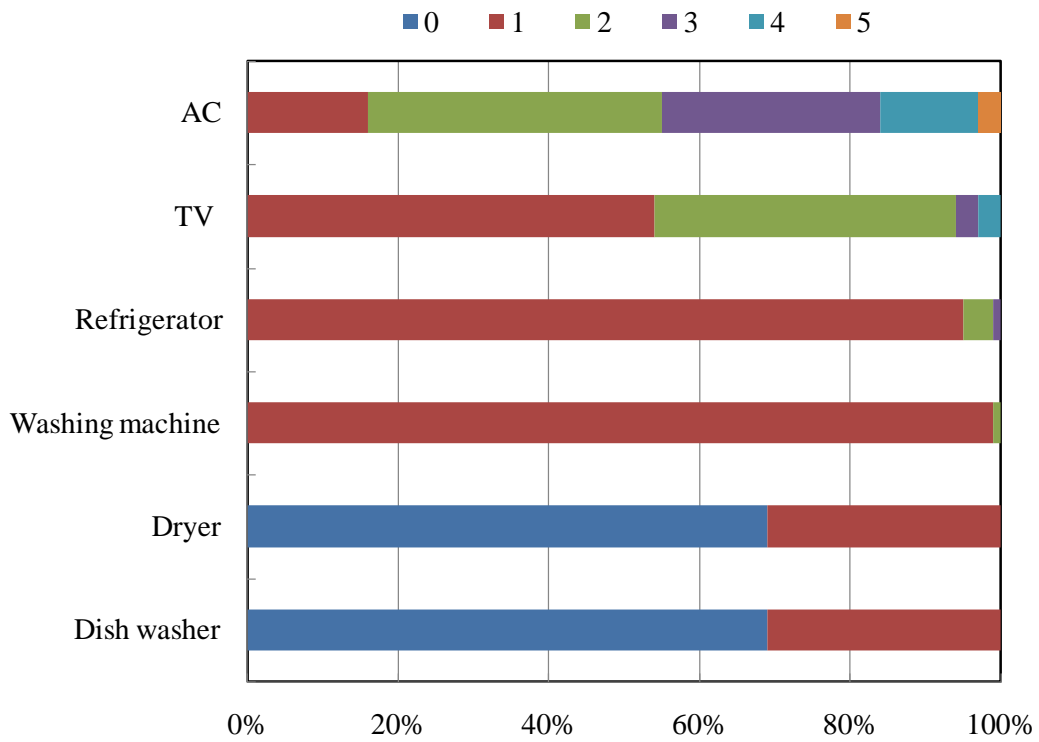

Figure 3-12 Household appliances information of group AB

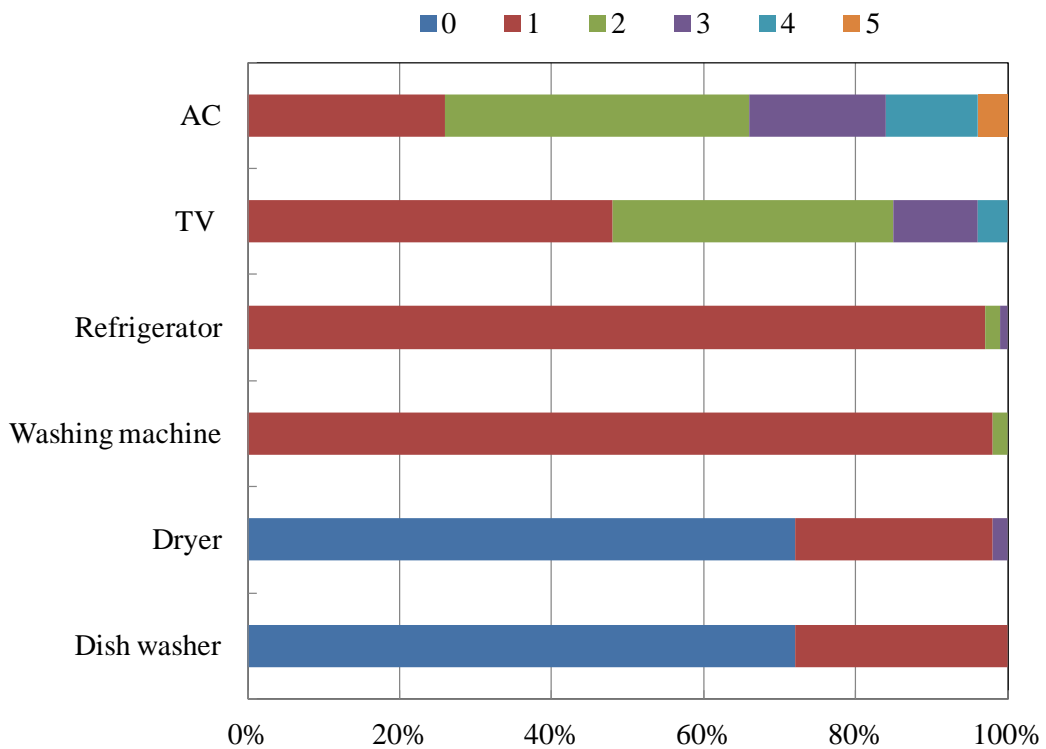

Figure 3-13 Household appliances information of group C

### 3.2.3 Electricity pricing system of the project

In this creation project, critical peak pricing is the basic dynamic pricing. This pricing system only set while some “special days”, such as the temperature is extremely high or the electricity demand exceeds the anticipation. Figure 3-14 presents the implementation example of this kind of dynamic pricing. CMES (cluster energy management systems) which is installed in the community control center responsible for the demand forecast of the next day and delivers the next day power rate table to all the end-users through BEMS and HEMS. According to this forecast information, EMS are able to generated an operation plan for the next day and sent it back to CEMS. Based on this feedback, CEMS will make the supply and demand plan for next day and do the deviation from supply and demand forecast threshold. Thus, re-calculated the pricing and sent the updated price to utility customers.

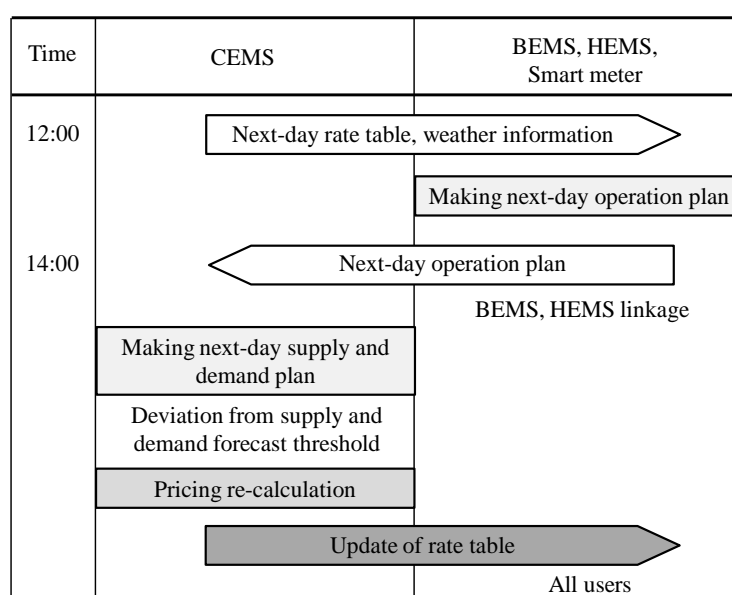

Figure 3-14 Implementation example of dynamic pricing

(Source: Fuji Electric)

Different electricity price system was introduced into ordinary families in order to investigate the relationship between the load reduction potential and the price rate level. Every family can confirm the price through the pad terminal (indoor display) which is connected to the smart meters through wireless LAN.

Figure 3-15 and figure 3-16 show the electric power rate system (summer and winter) at the demonstration test in 2012. Basic price which was shown in figure is applied by control group. As for treatment group, five stages of electricity price from Level 1 (15 JPY/kWh) to Level 5 (150 JPY/kWh) were prepared for them in peak period. In summer, dynamic price is set from 13:00 to 17:00 during the daytime. In winter, dynamic price is set from 8:00 to 10:00 in the morning and 18:00 to 20:00 in the evening.

Figure 3-17 and figure 3-18 show the electric power rate system (summer and winter) at the demonstration test in 2013. The price level is the same. But in 2013 summer, the basic price and the non-DP period price of electricity are not same with that in 2012 summer, the price had increased a little. In 2013 winter, the dynamic price r is a little different. Only three stages of

**CHAPTER THREE: EXPLORATORY ANALYSIS OF KITAKYUSHU RESIDENTS  
RESPONSE TO DYNAMIC ELECTRICITY PRICING**

electricity price from Level 1 (15 JPY/kWh) to Level 3 (100 JPY/ kWh) were prepared for residents in winter.

Table 3-6 shows the detailed information of electricity pricing system, including the electricity price of middle period seasons and non-DP time blocks.

Table 3-7 is the number of the dynamic pricing implement days in different level price. It is obvious that DP had been event 30 days in 2012 summer, 42 days in 2012 winter, 45 days in 2013 summer and 38 days in 2013 winter respectively according to its setting rule. The number of DP days in different price levels almost was the same. In addition, dynamic price only been implemented when the highest temperature forecast exceeds 30 °C for summer or the temperature forecast between -1°C and 9 °C for winter.

Table 3-6 Detailed Information of electricity pricing system

Period	Time	DP (JPY/kWh)	Non DP (JPY/kWh)
July, August, September	8:00-10:00	10	
	10:00-13:00	15	
	13:00-17:00	50/75/100/150	15
	17:00-22:00	10	
	22:00-8:00	5.94	
December, January, February	8:00-10:00	50/75/100/150	15
	10:00-18:00	15	
	18:00-20:00	50/75/100/150	15
	20:00-22:00	10	
	22:00-8:00	5.94	
Other months	8:00-17:00	10(Jun.&Oct.)/15(June&Nov.&Mar.) /17.55(Apr.&May)/23.36(Apr.&May)	
	17:00-22:00	10(July&Oct.&Nov.&Mar.)/ 15(June)/17.55(Apr.&May)	
	22:00-8:00	5.94	

Table 3-7 Number of the DP implement days in different level

DP event days	level 2	level 3	level 4	level 5	Total
2012 summer	8	7	8	7	30
2012 winter	10	11	11	10	42
2013 summer	11	11	11	12	45
2013 winter	16	-	22	-	38
Total	45	29	52	29	155

CHAPTER THREE: EXPLORATORY ANALYSIS OF KITAKYUSHU RESIDENTS  
RESPONSE TO DYNAMIC ELECTRICITY PRICING

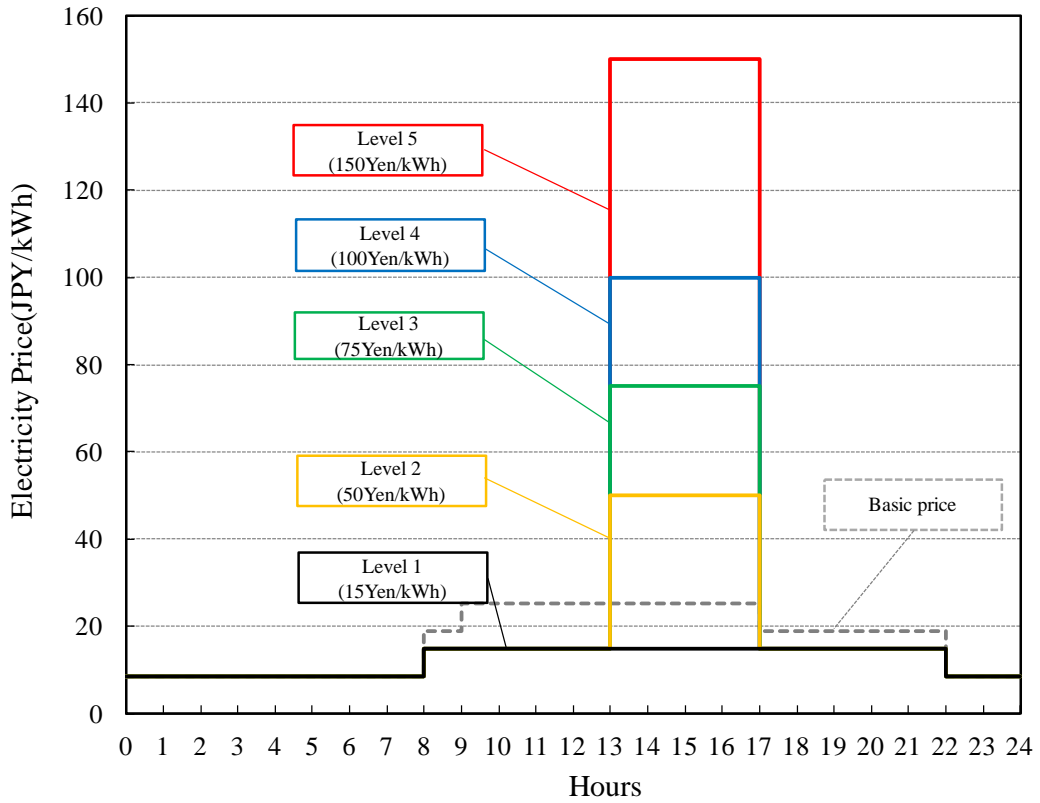

Figure 3-15 Dynamic electricity pricing in 2012 summer

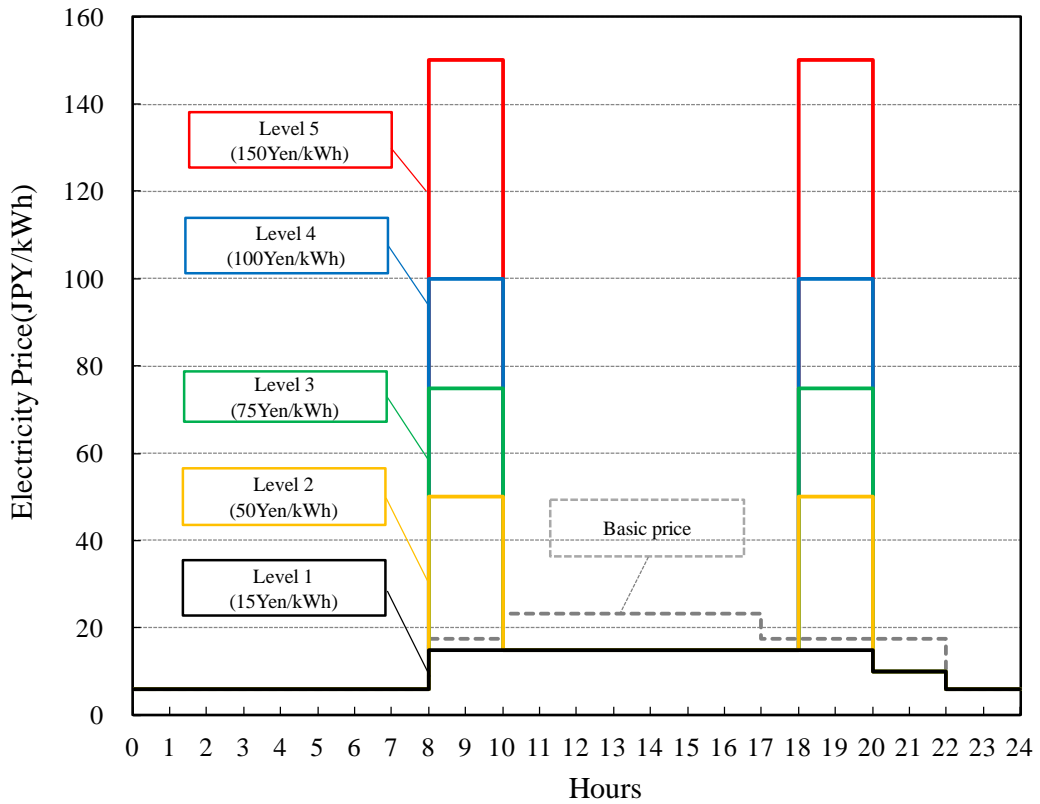

Figure 3-16 Dynamic electricity pricing in 2012 winter



CHAPTER THREE: EXPLORATORY ANALYSIS OF KITAKYUSHU RESIDENTS  
RESPONSE TO DYNAMIC ELECTRICITY PRICING

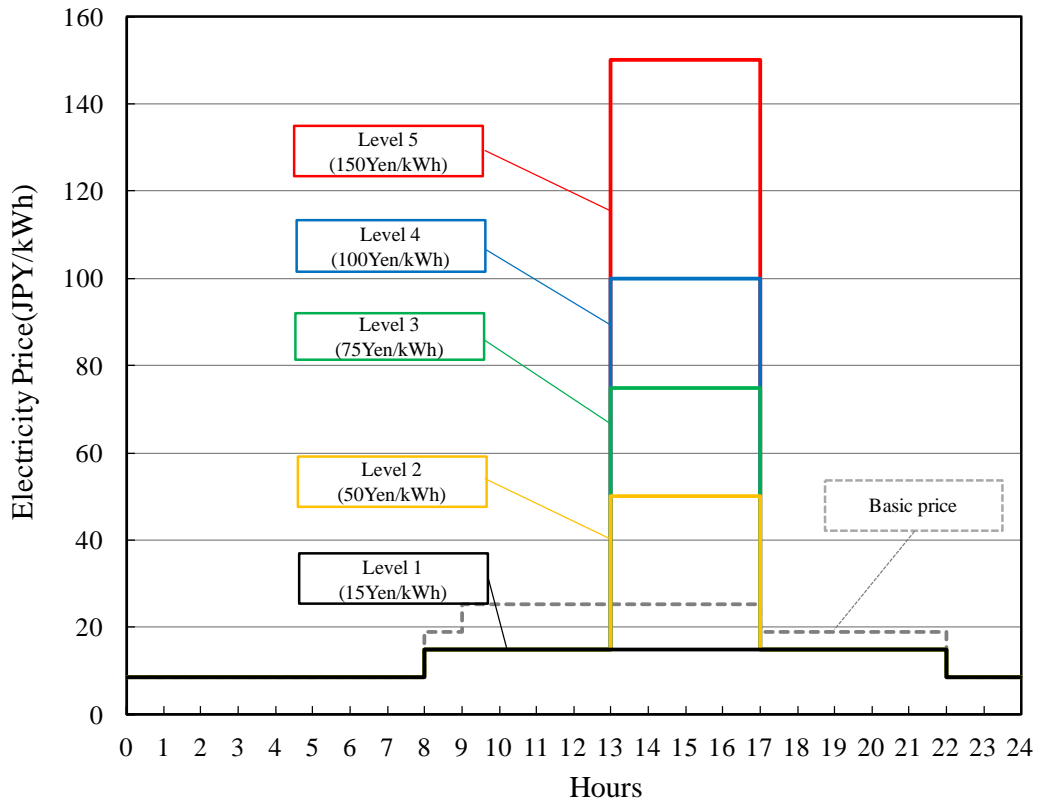

Figure 3-17 Dynamic electricity pricing in 2013 summer

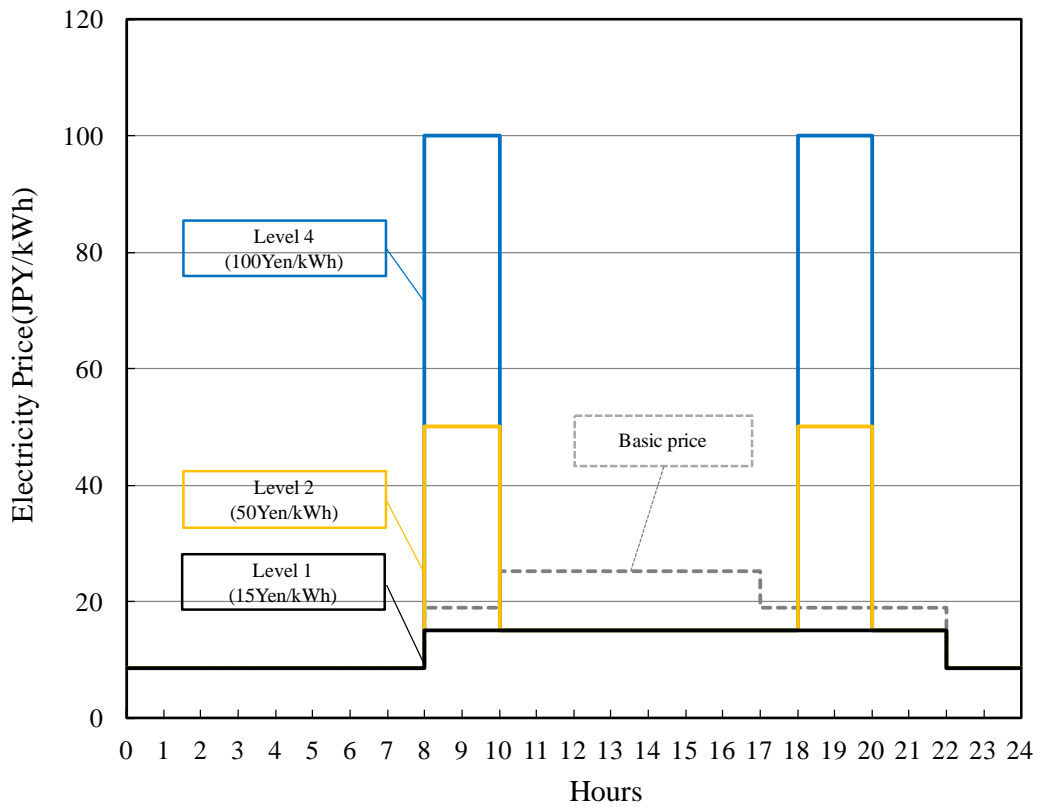

Figure 3-18 Dynamic electricity pricing in 2013 winter

**CHAPTER THREE: EXPLORATORY ANALYSIS OF KITAKYUSHU RESIDENTS  
RESPONSE TO DYNAMIC ELECTRICITY PRICING**

**3.3 Energy consumption of the target Residential house**

Table 3-8 shows the basic data information which we can collect from smart meter and Kitakyushu City. As for 2010 and 2011, we can only get the monthly data. As for 2012 and 2013, there are half an hour data owing to the introduction of smart meter since the implementation of SC creation project.

Table 3-8 Basic Data Information of Electricity Consumption

Date	Basic data
2010(2010.04-2011.03)	Monthly data
2011(2011.04-2012.03)	Monthly data
2012(2012.04-2013.03)	Half an hour data
2013(2013.04-2014.03)	Half an hour data

In addition, we recognized the time period from April, last year to March, next year as a whole year due to the smart meter starts to collect data from April, 2012. Here, summer includes June, July, August and September. Winter includes December, January, February and March, and the value of electricity consumption is the average of all households in each group.

**3.3.1 The yearly electricity consumption**

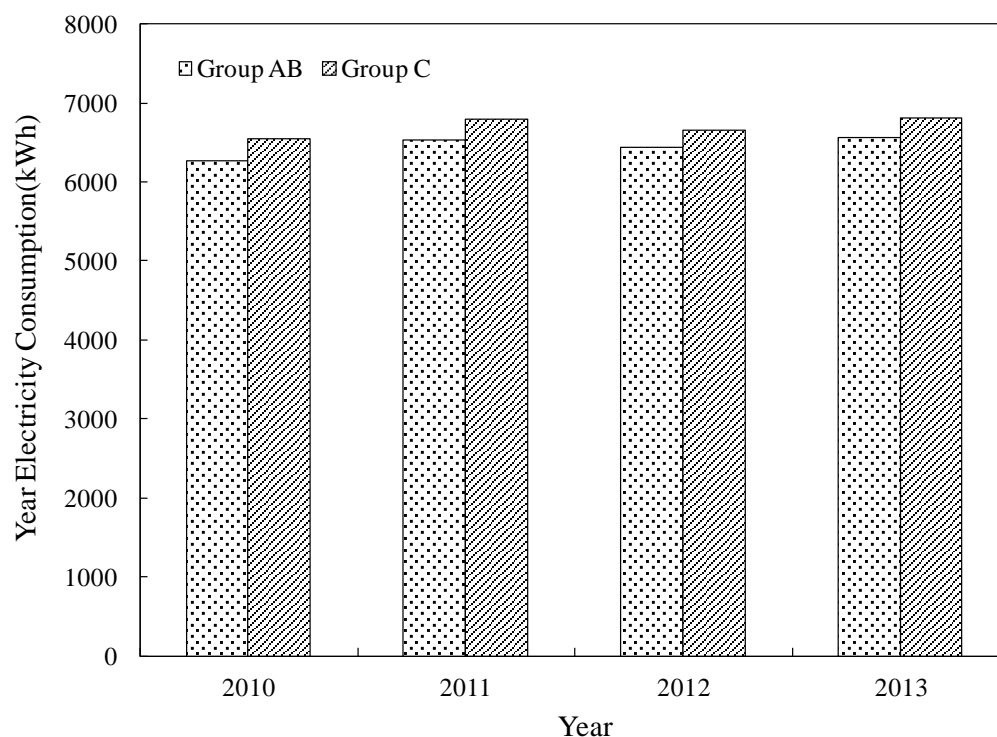

Figure 3-19 Year electricity consumption of two groups

### CHAPTER THREE: EXPLORATORY ANALYSIS OF KITAKYUSHU RESIDENTS RESPONSE TO DYNAMIC ELECTRICITY PRICING

In this section, we mainly analyze the electricity consumption of target households. There is difference between yearly electricity consumption of two groups, owing to the distinction of house area, family size and household appliances, etc. For example, the household of one person with a few basic appliances will lead to less energy consumption compared to the household of 4 people with enough appliances ignored its necessity.

Figure 3-19 explains the year electricity consumption of group AB and group C in four years (from 2010 to 2013). It is obvious that over these four years, the electricity consumption mode is almost same, just a little difference. From the perspective of yearly electricity consumption, the value of treatment group AB always lower than that of control group C. What's more, even dynamic pricing has been implemented since 2012, It still cannot see the significant difference of the electricity consumption between DP event year and DP no event year. Therefore, we need to make penetrating analysis of the DP effect.

#### ■ Relationship between year electricity consumption and house attributes

There are two elements (floor area and family size) which have been considered in discussing relationship between year electricity consumption and house attributes.

Figure 3-20 shows the year electricity consumption of group AB and group C across different floor area. It is obvious that group AB and group C have the same tendency and the larger the floor area, the higher the annual electricity consumption. Figure 3-21 shows the year electricity consumption of group AB and group C across different family size. As for group AB, there is a tendency that the larger the family size, the higher the electricity consumption. Group C shows that almost the same trend as group AB. But for the family size of 4 and 5, the electricity consumption is declined compared to that of family size 3. This is owing to that there are only two household samples of 5 person family, the result are not representative.

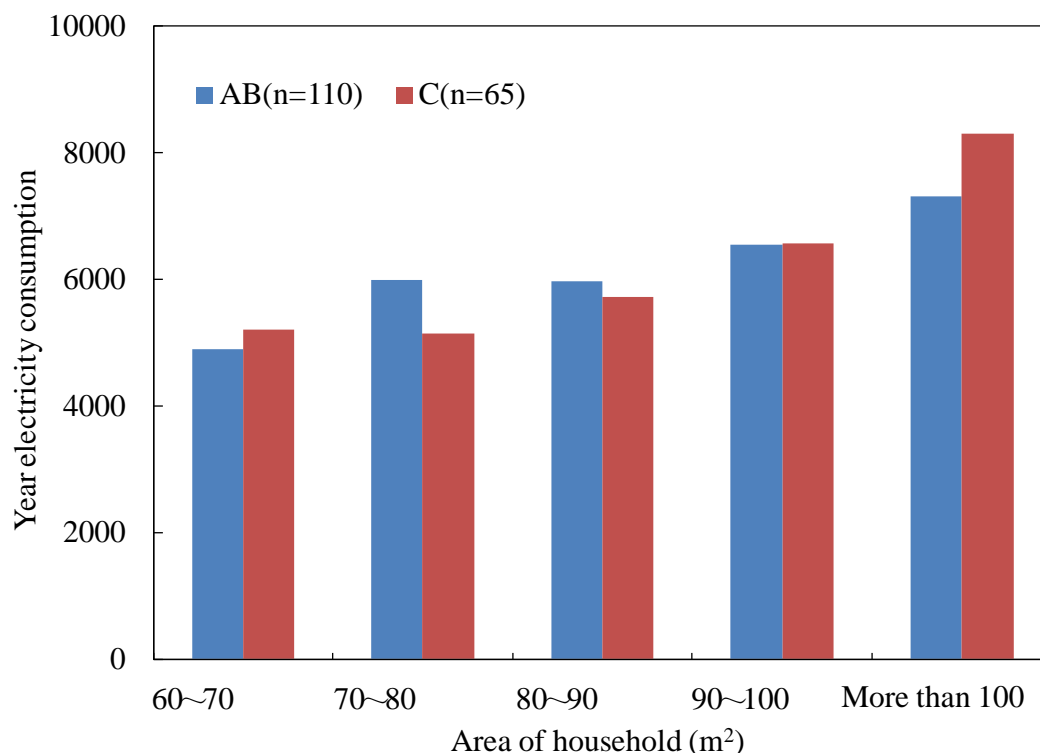

Figure 3-20 Year electricity consumption of group AB and group C across different floor area

CHAPTER THREE: EXPLORATORY ANALYSIS OF KITAKYUSHU RESIDENTS  
RESPONSE TO DYNAMIC ELECTRICITY PRICING

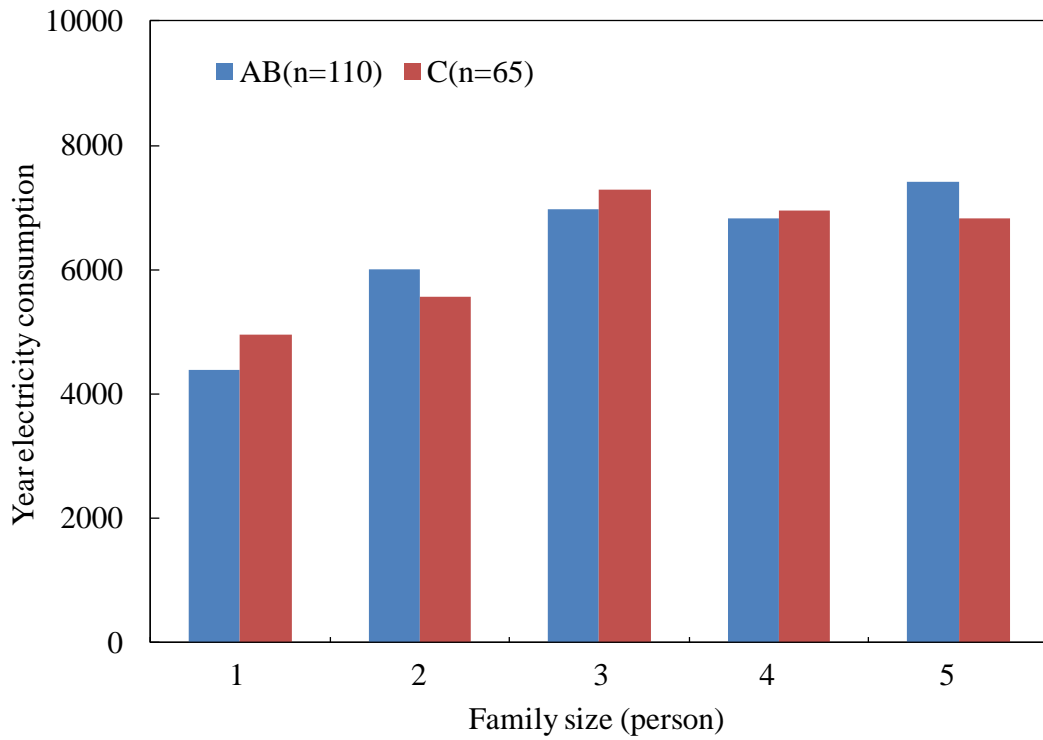

Figure 3-21 Year electricity consumption of group AB and group C across different family size

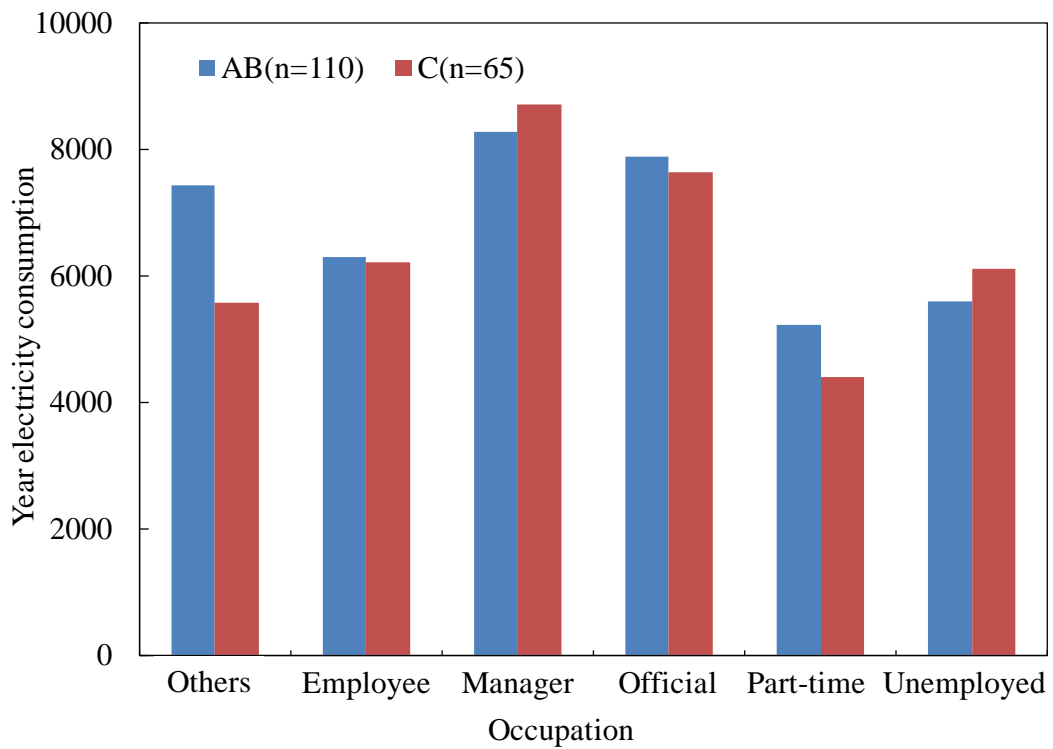

Figure 3-22 Year electricity consumption of group AB and group C across different occupation

CHAPTER THREE: EXPLORATORY ANALYSIS OF KITAKYUSHU RESIDENTS  
RESPONSE TO DYNAMIC ELECTRICITY PRICING

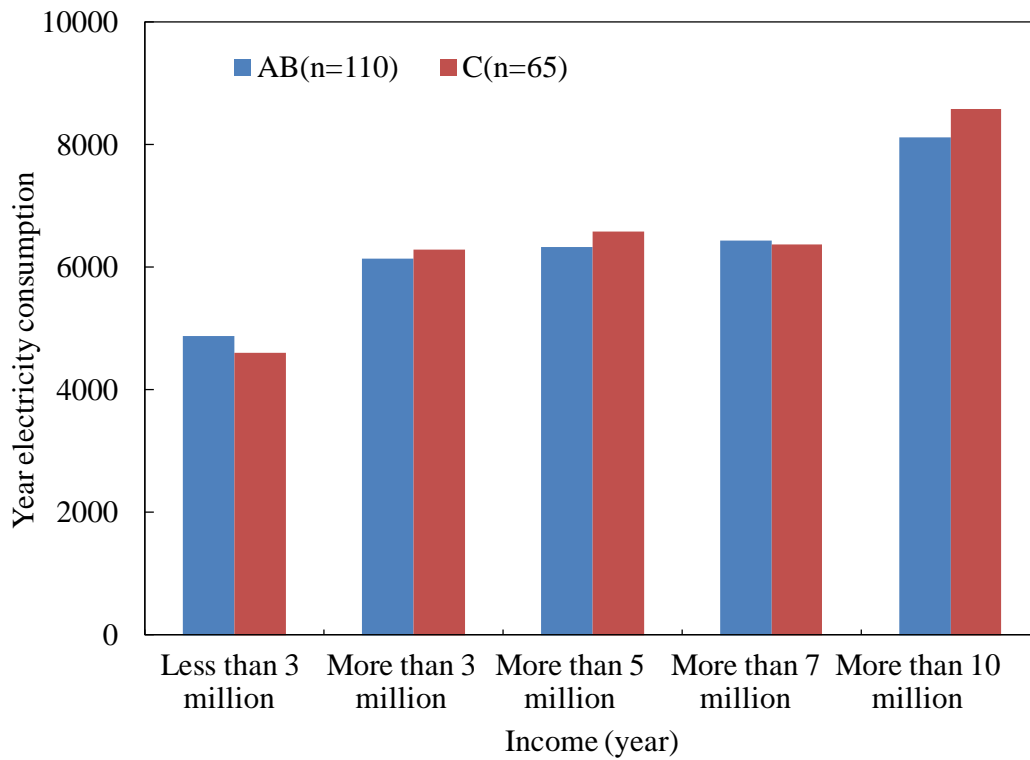

Figure 3-23 Year electricity consumption of group AB and group C across different income degree

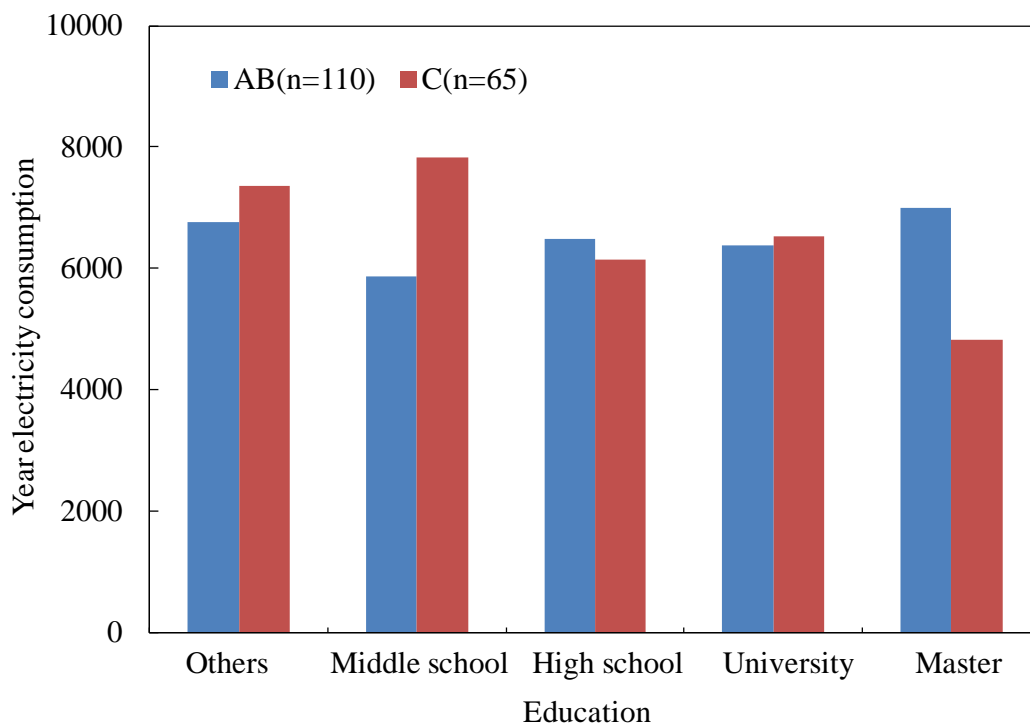

Figure 3-24 Year electricity consumption of group AB and group C across different education level

CHAPTER THREE: EXPLORATORY ANALYSIS OF KITAKYUSHU RESIDENTS  
RESPONSE TO DYNAMIC ELECTRICITY PRICING

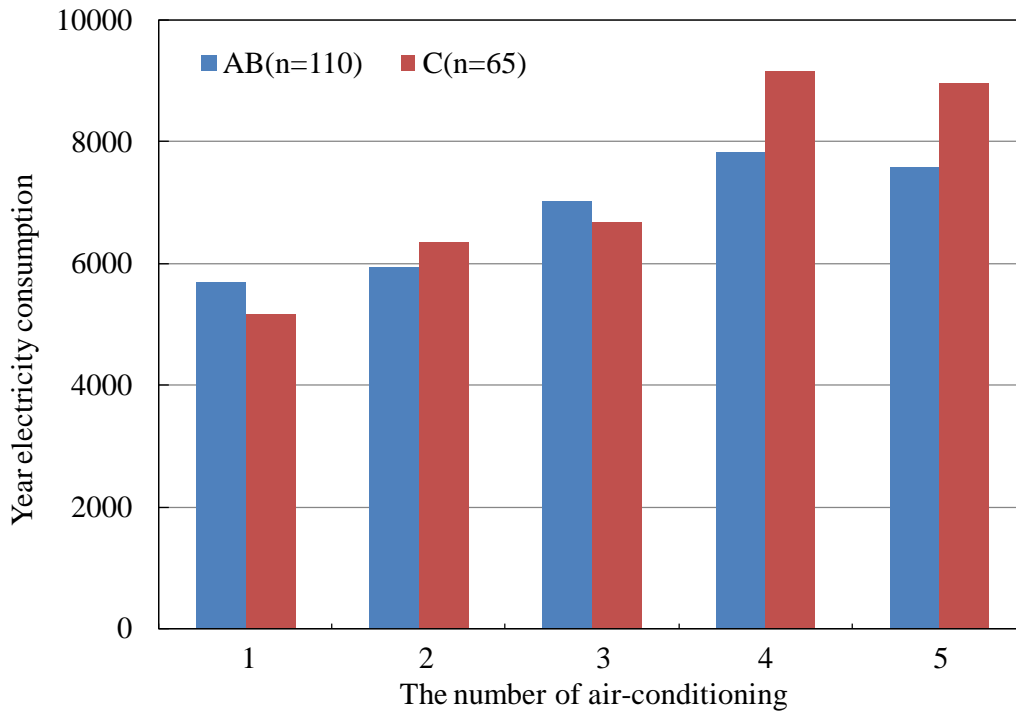

Figure 3-25 Year electricity consumption of group AB and group C across different number of AC

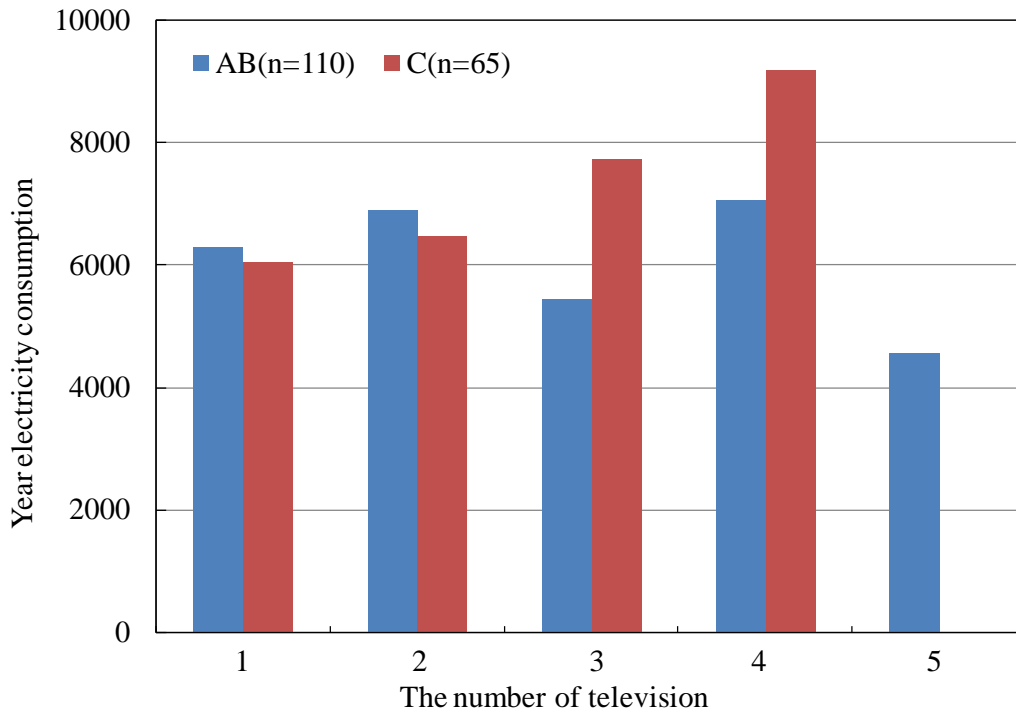

Figure 3-26 Year electricity consumption of group AB and group C across different number of TV

## CHAPTER THREE: EXPLORATORY ANALYSIS OF KITAKYUSHU RESIDENTS RESPONSE TO DYNAMIC ELECTRICITY PRICING

### ■ Relationship between year electricity consumption and household attributes

Figure 3-22 shows the year electricity consumption of group AB and group C across different occupation. It is obvious that the manager/staff and official holds the higher electricity consumption. Figure 3-23 presents the year electricity consumption of group AB and group C across different income degree. It tells us that group AB and group C have the same tendency and the larger the income, the higher the annual electricity consumption. The household which has more than 10 million incomes have the largest electricity consumption. Figure 3-24 shows the year electricity consumption of group AB and group C across different education level. Neither group AB nor group C has not close relationship between each household's academic background and its annual electricity consumption.

### ■ Relationship between year electricity consumption and household appliances

Figure 3-25 shows the year electricity consumption of group AB and group C across different number of air-conditioning. It is obvious that group AB and group C have the same tendency and the larger the number of air conditioner, the higher the annual electricity consumption. But in terms of the households of group AB who have 5 air conditioners, its electricity consumption is lower than that of households with 4 air conditioners. The reason is that there are less than 3 household samples of families with 5 air conditioners, the result are not representative. Another reason is that with the equipment of DP, households with five air conditioners may not actually use all air conditioners. Figure 3-26 shows the year electricity consumption of group AB and group C across different number of television. Group C shows the well relationship between year electricity consumption and television numbers. But for group AB, the annual electricity consumption is not tightly related to the TV numbers. The possible reason is as same as that of air conditioning.

### **3.3.2 The monthly electricity consumption**

Figure 3-27 and figure 3-28 illustrate the monthly electricity consumption of group AB and group C in four years. It is obvious that the electricity consumption mode of group AB and group C in these four years are similar, except the tiny value difference. On the average, the maximum value of electricity consumption for these two groups is about 800 kW, and the minimum value is about 400 kW. As for 2010, the electricity consumption of January is extremely high almost reached to 1100 kW due to the cold weather compared to other three years. The electricity consumption difference among four years in summer (July, August and September) and winter (December, January, February) is obvious than that in middle period. In addition, the electricity consumption of winter is far higher than summer, caused that most households use electricity to get hot water and heating in winter.

Figure 3-29, 3-30, 3-31 and figure 3-32 shows the monthly electricity consumption of households in four years, respectively. The DP was not introduced into households in 2010 and 2011, and was equipped in 2012 and 2013. From the figure, we can see that with the electricity consumption of group AB is a little lower than the electricity consumption of group C.

CHAPTER THREE: EXPLORATORY ANALYSIS OF KITAKYUSHU RESIDENTS  
RESPONSE TO DYNAMIC ELECTRICITY PRICING

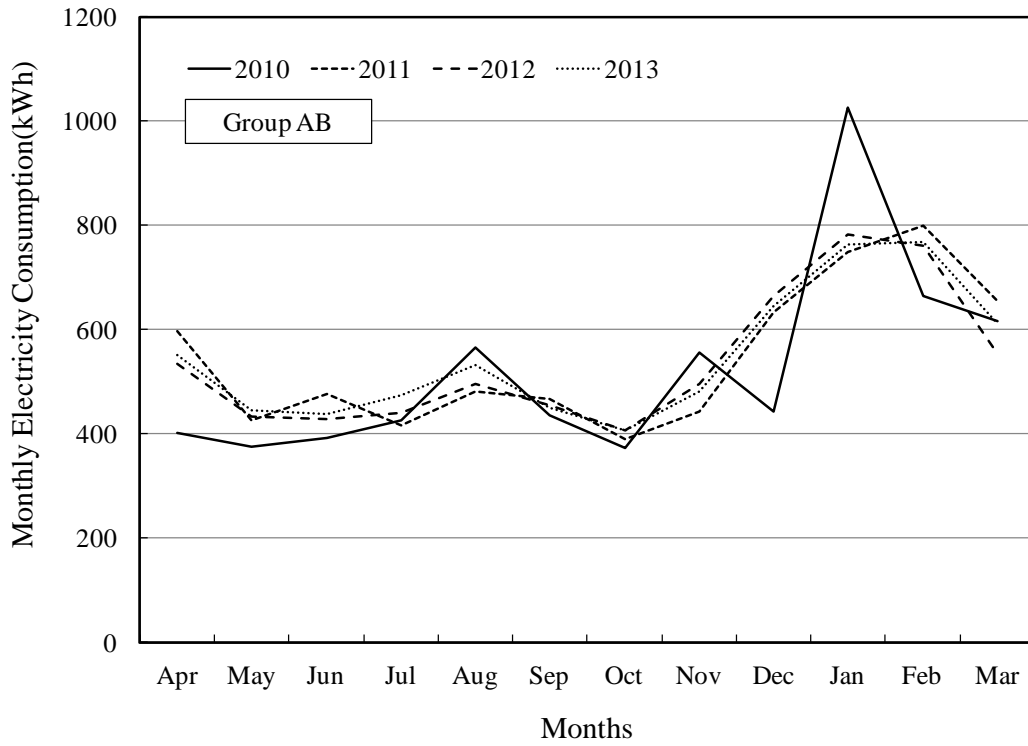

Figure 3-27 Monthly electricity consumption of group AB

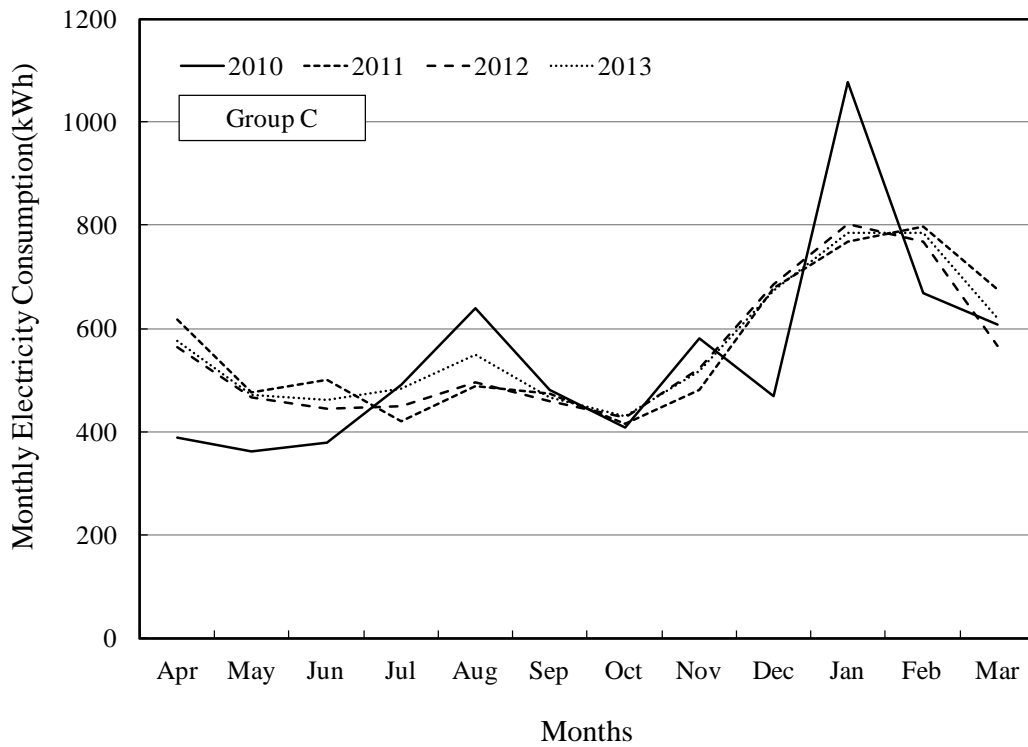

Figure 3-28 Monthly electricity consumption of group C



CHAPTER THREE: EXPLORATORY ANALYSIS OF KITAKYUSHU RESIDENTS  
RESPONSE TO DYNAMIC ELECTRICITY PRICING

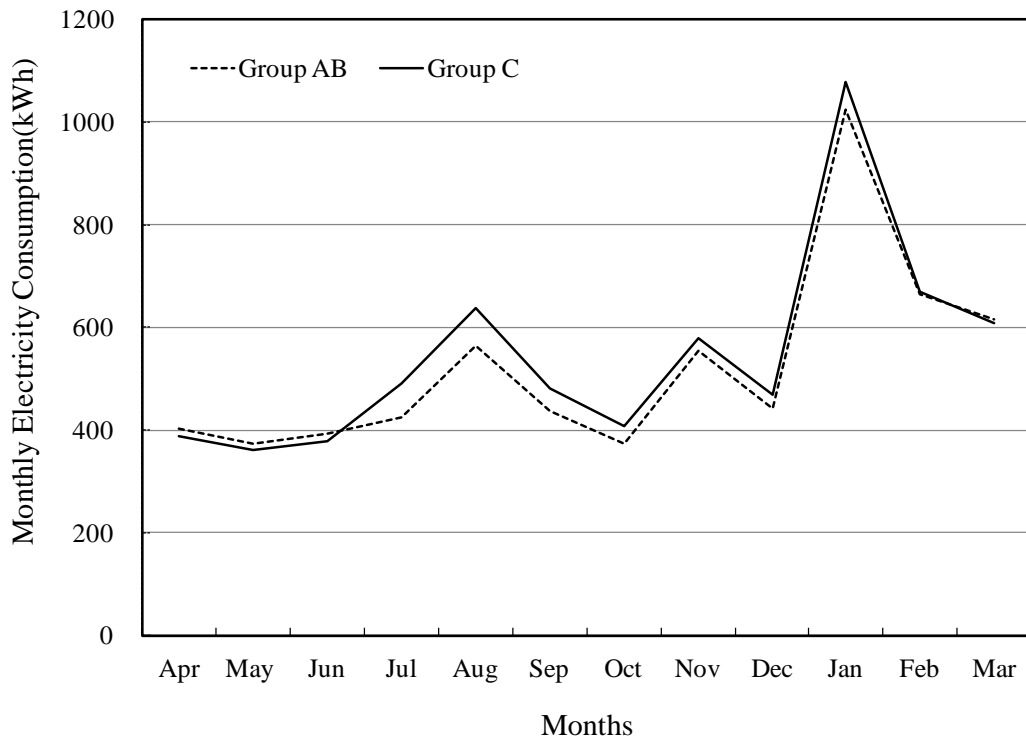

Figure 3-29 Monthly electricity consumption of households in 2010

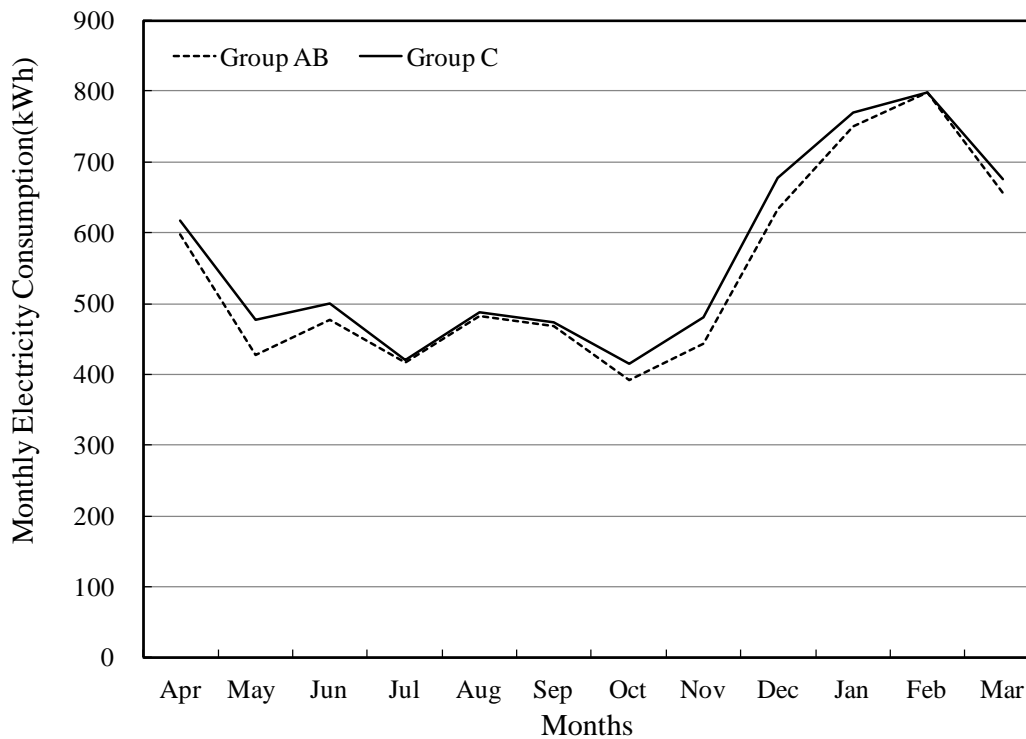

Figure 3-30 Monthly electricity consumption of households in 2011

CHAPTER THREE: EXPLORATORY ANALYSIS OF KITAKYUSHU RESIDENTS  
RESPONSE TO DYNAMIC ELECTRICITY PRICING

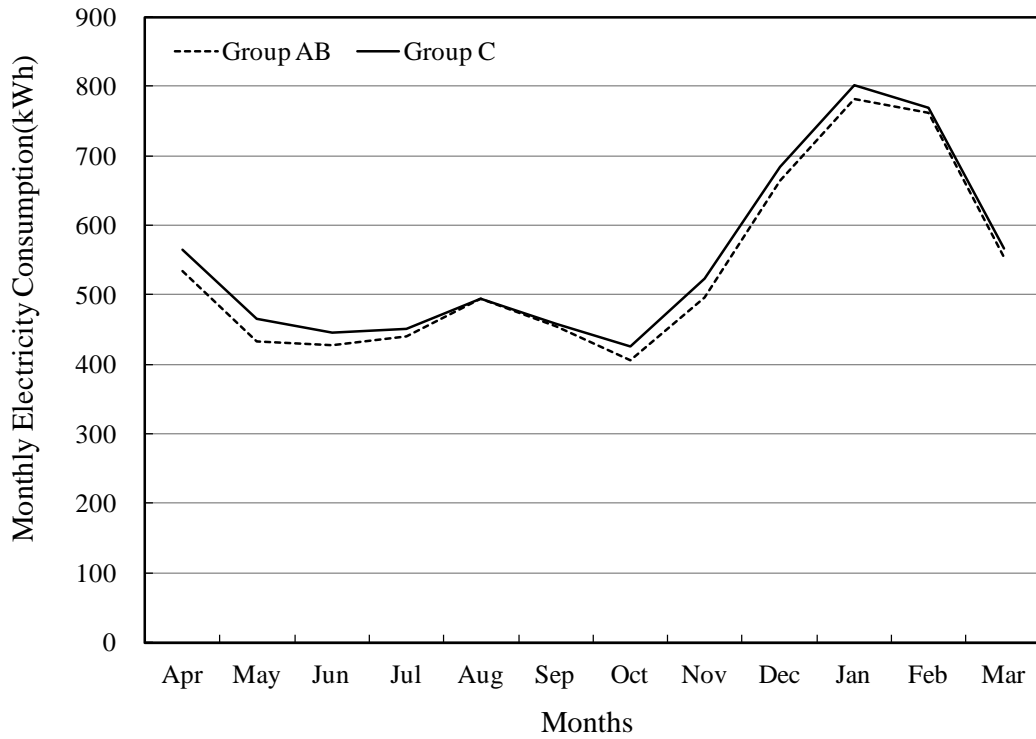

Figure 3-31 Monthly electricity consumption of households in 2012

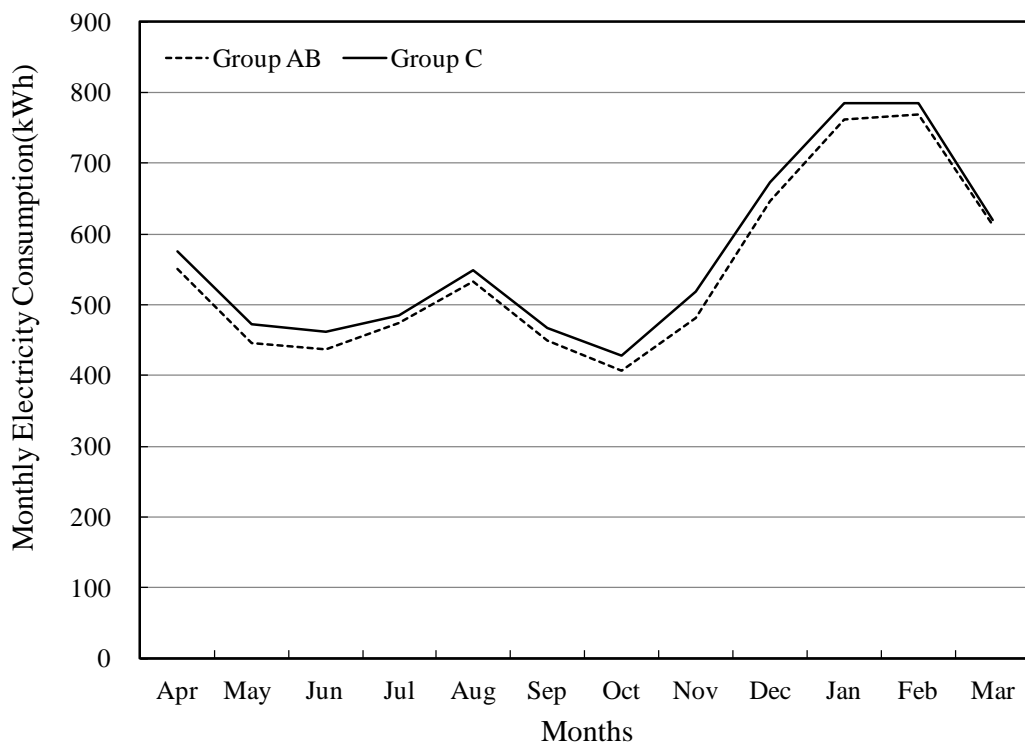

Figure 3-32 Monthly electricity consumption of households in 2013

## CHAPTER THREE: EXPLORATORY ANALYSIS OF KITAKYUSHU RESIDENTS RESPONSE TO DYNAMIC ELECTRICITY PRICING

### 3.3.3 The hourly electricity consumption

Figure 3-33 and 3-34 is the daily electricity consumption of group AB and group C in 2012 summer and winter. It is the first year that the dynamic pricing was implemented. Figure 3-27 and 3-28 is the daily electricity consumption of group AB and group C in 2013 summer and winter. As for four figures, X coordinate indicates the hours of one day, and Y coordinate indicates the average electricity consumption every half an hour, and it is the average value for all households.

Figure 3-33 and 3-34 also reveals the comparison of the demand curve (average value) between the group AB and group C in 2012. And dynamic pricing was totally implemented for 40 days in summer and 42 days in winter respectively according to its setting rule. From the figure, it is obvious that both in summer and winter, dynamic pricing was appropriately performed in the reduction of electricity load during peak/event period, besides, outside the event period, the difference between usage values on normal and critical days is negligible. It also demonstrates that with the incentive of high critical electricity price, residents of group AB did some corresponding energy saving actions.

As for 2013, the comparison of the demand curve (average value) between the group AB and group C shows the almost same tendency compared to that in 2012. The detailed information can be shown in Figure 3-35 and 3-36.

CHAPTER THREE: EXPLORATORY ANALYSIS OF KITAKYUSHU RESIDENTS  
RESPONSE TO DYNAMIC ELECTRICITY PRICING

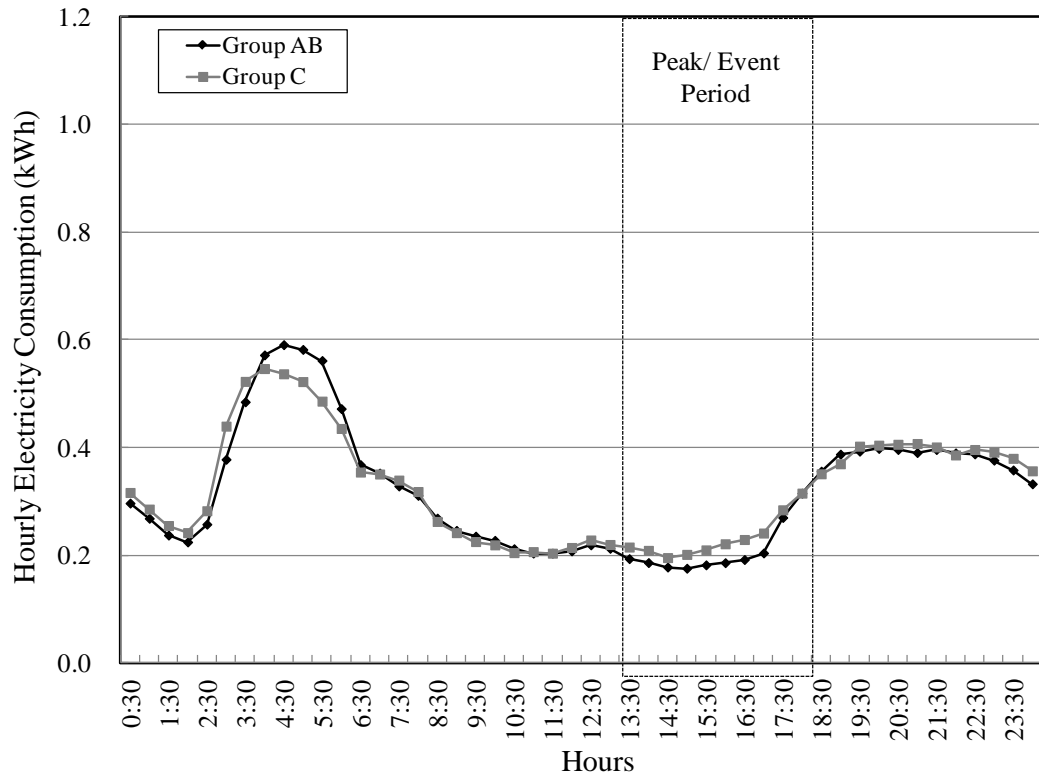

Figure 3-33 Hourly electricity consumption of households in 2012 summer

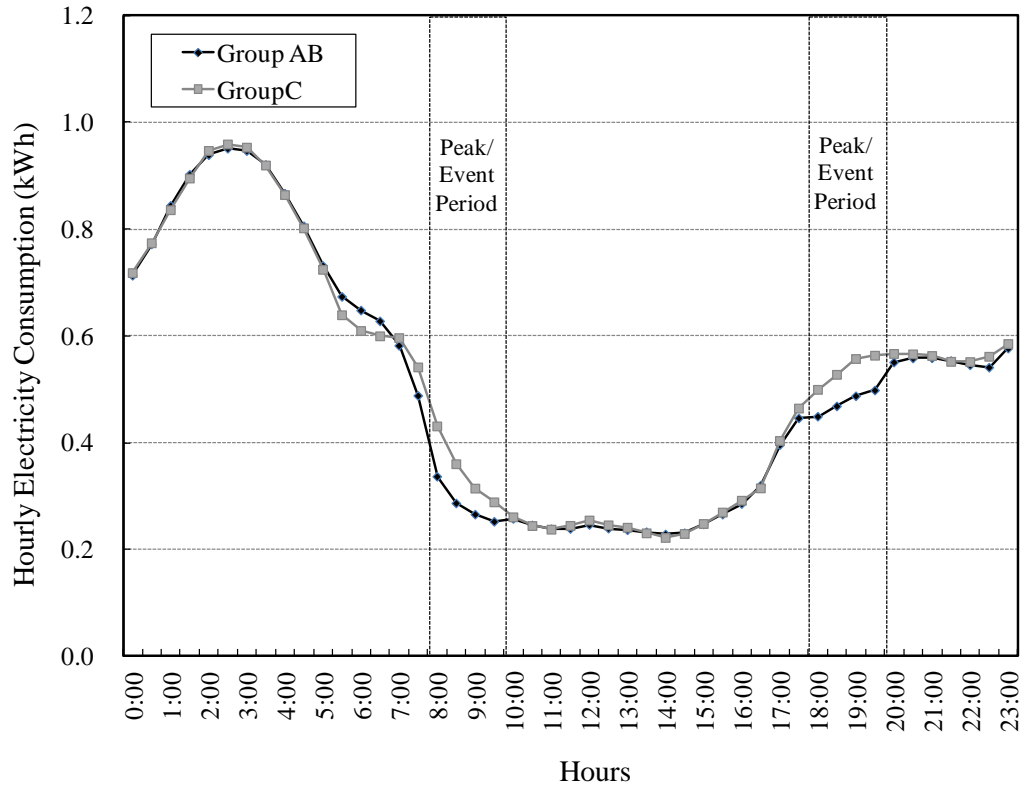

Figure 3-34 Hourly electricity consumption of households in 2012 winter

CHAPTER THREE: EXPLORATORY ANALYSIS OF KITAKYUSHU RESIDENTS  
RESPONSE TO DYNAMIC ELECTRICITY PRICING

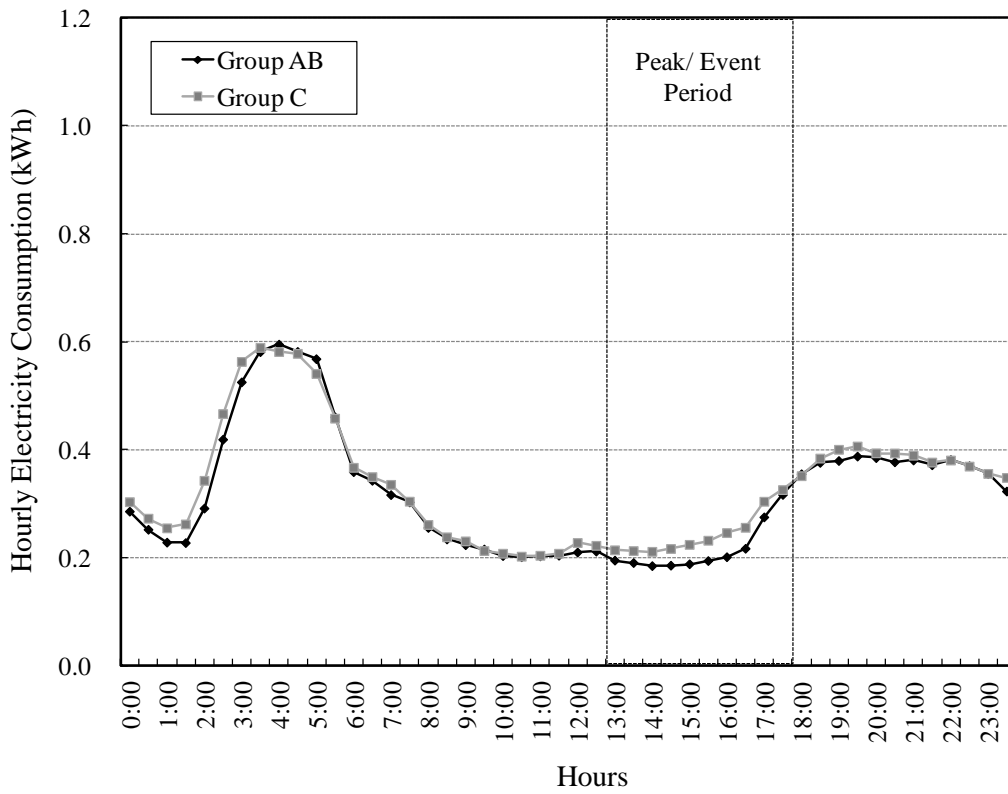

Figure 3-35 Hourly electricity consumption of households in 2013 summer

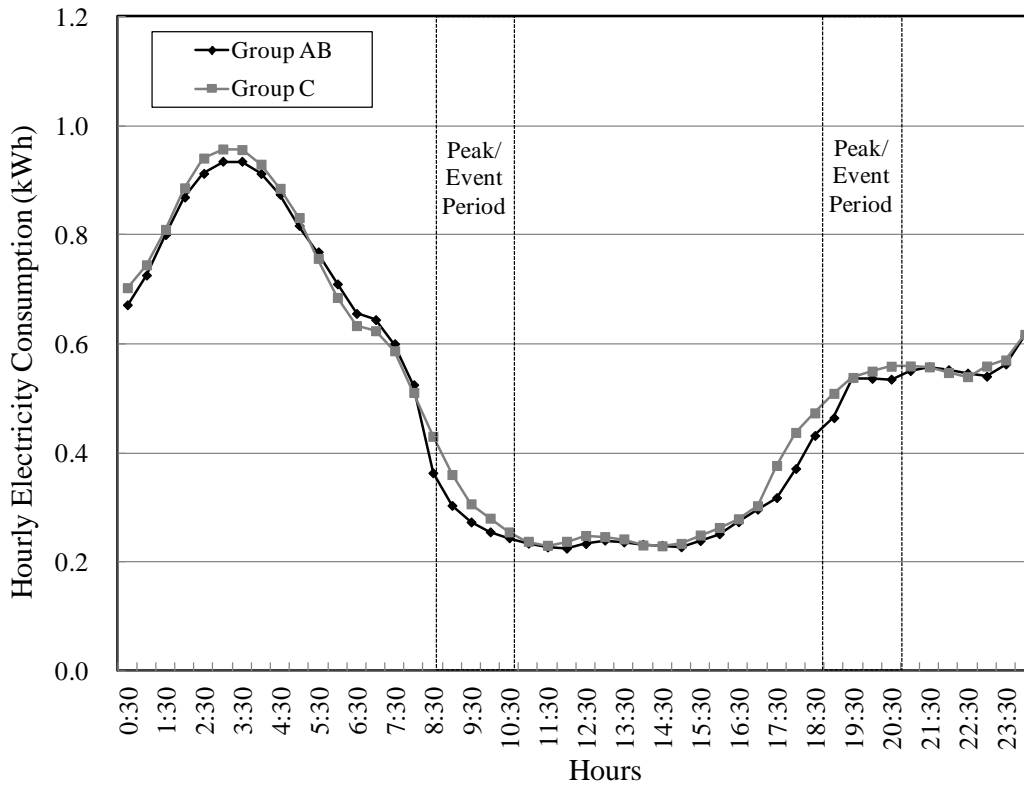

Figure 3-36 Hourly electricity consumption of households in 2013 winter

### 3.4 Residents Response to Dynamic Electricity Pricing

#### 3.4.1 Dynamic electricity pricing effect influenced by temperature

The link between temperature and energy consumption is rather intuitive. Higher temperatures may raise energy demand caused that more energy (in particular, electricity) will be needed to run air conditioners and other cooling devices in the summer. Lower temperatures still may increase the energy consumption due to the more energy resources will be needed for heating purposes in the winter season. Figure 3-37 and figure 3-38 proved this statement. Therefore, it is necessary to investigate the influence of temperature factor on the implementation effect of dynamic pricing.

Figure 3-39 shows the relationship between electricity consumption and temperature. Through comparing the trend line of group C and group AB in winter, there was a significant phenomenon that the lower the temperature was, the stronger the dynamic price effect. However, in summer, it indicates that the relationship between temperature and electricity usage is not as closely as that in winter. The gap between the electricity consumption of group C and group AB was not increased as the increase of temperature.

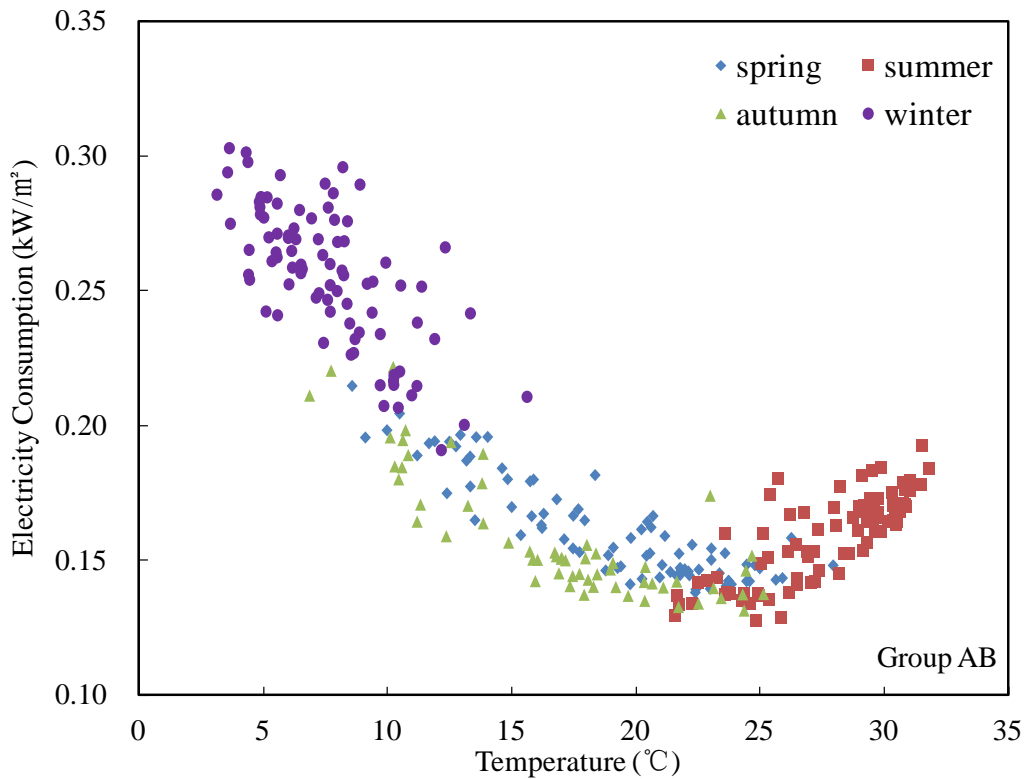

Figure 3-37 Relationship between electricity consumption and temperature in 2012 of group AB

CHAPTER THREE: EXPLORATORY ANALYSIS OF KITAKYUSHU RESIDENTS  
RESPONSE TO DYNAMIC ELECTRICITY PRICING

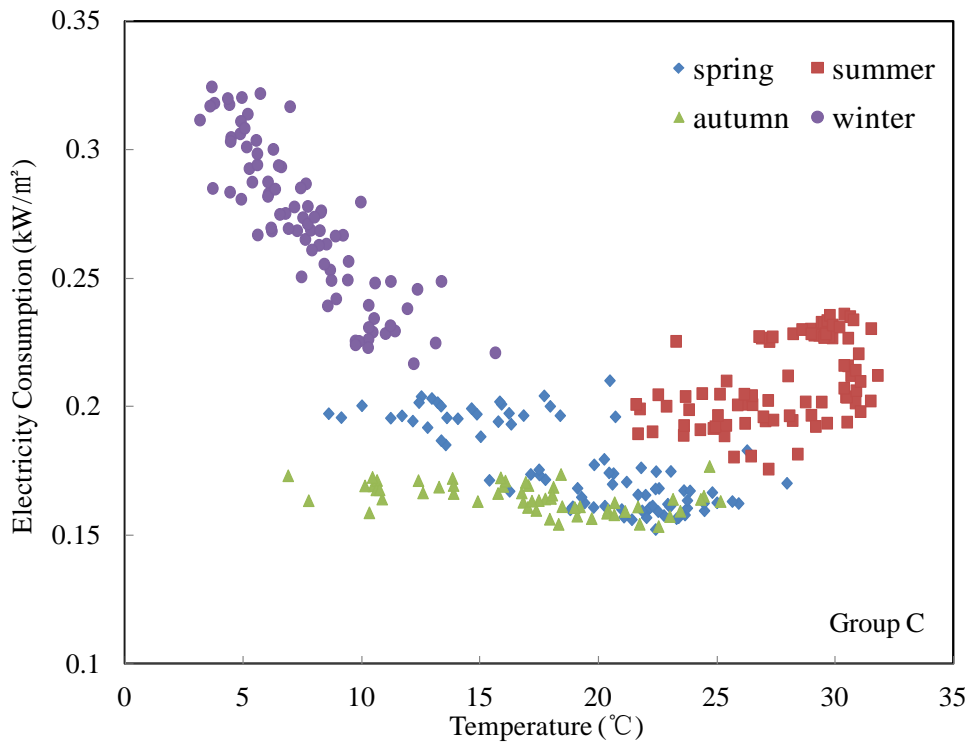

Figure 3-38 Relationship between electricity consumption and temperature in 2012 of group C

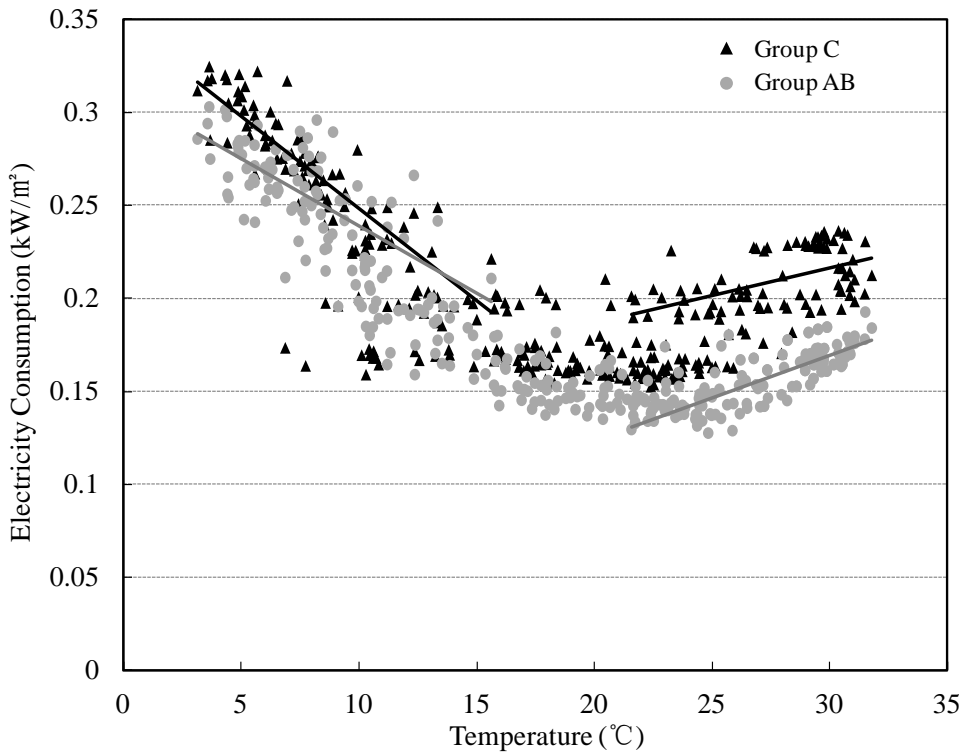

Figure 3-39 Relationship between electricity consumption and temperature in 2012  
of group AB and Group C

### 3.4.2 Dynamic electricity pricing effect influenced by floor area

Figure 3-40 illustrates the electricity decrease ratio across different floor areas. It shows that the implementation effect of dynamic price is well performed in the households with the floor area from 80 to 90 m<sup>2</sup> and above 100 m<sup>2</sup>. There are mainly two reasons to explain it according to the questionnaire which made by Kitakyushu city. Firstly, these two kinds of households have more appliances (dish washer, dryer, TV, etc) than the others which can provides them much possibility to adjust their electricity using habits to the dynamic pricing. Secondly, the income and education levels of these two kinds of households is higher than that of others which may results in the difference of their electricity saving consciousness.

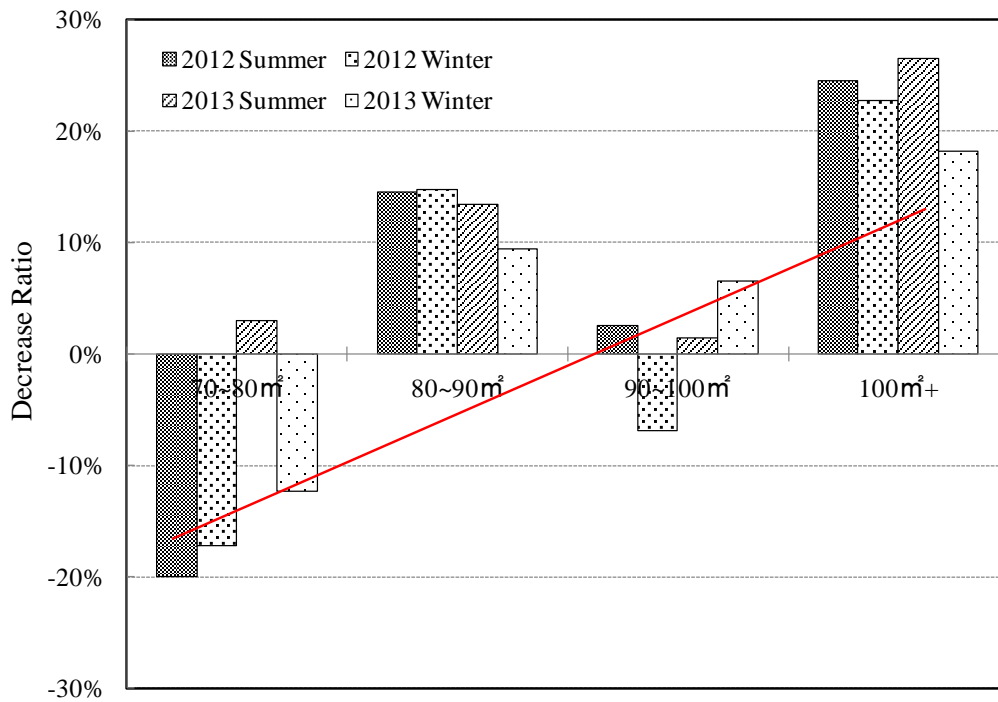

Figure 3-40 Electricity decrease ratio across different floor areas



### 3.4.3 Dynamic electricity pricing effect influenced by price level

Figure 3-41 indicates the electricity decrease ratio across different levels of electricity price. The peak demand reduction ratio changes from 6% to 14% in different situations. There is a tendency show the higher effect in the higher level which proved the effectiveness of the dynamic price. In addition, the dynamic price effect in 2012 is obviously better than that in 2013 due to the residents was already accustomed to dynamic price and lack of curious and motivation.

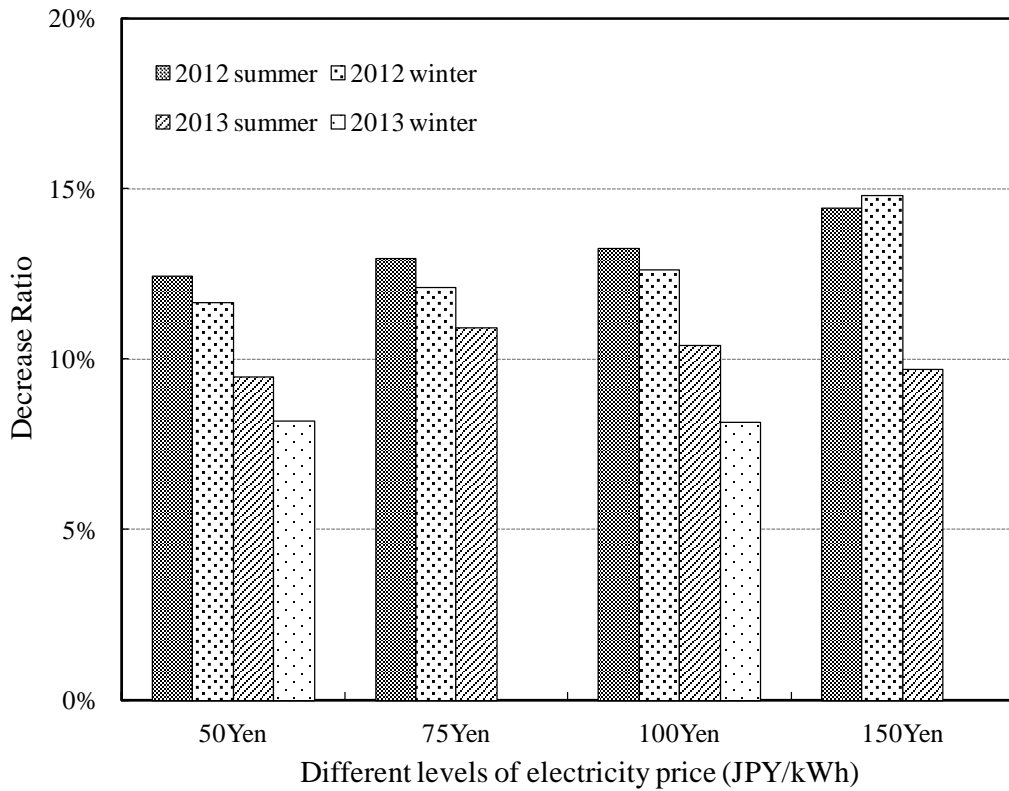

Figure 3-41 Electricity decrease ratio across different levels of electricity price

### **3.4.4 Dynamic electricity pricing effect influenced by consciousness**

Consumers have the potential to play an important role in addressing climate change problems through a better implementation of DP. On the demand-side, the consumers that with high consciousness of energy saving are expected to play a more active role in managing electricity consumption rather than being usual users only. Even consumers are essential to the DP process, little is known about how consumers perceive, and how they might respond to the opportunities that DP offer [7]. This part reports some results related to residential consciousness from a questionnaire that made by Kitakyushu City, try to analyze the association between the residents awareness and the electric consumption.

#### ✧ Questionnaire results

The number of households who take part in the survey in Kitakyushu smart community is 68. Group AB (Treatment group) has 43 households, and 25 households in Group C. Table 3-9 shows the questionnaire results of Group AB and Group C, which including participates number, effective number and response rate.

There are 120 households in Group AB. The number of participants is 47 and the participation rate is 39.2%. Among them, the effective number of which responded questionnaires is 43, the response rate is 91.5%. Group C has a total of 70 households, the number of participants is 27 and the participation rate is 38.6%. Among them, the effective number of which responded questionnaires is 25, the response rate is 92.6%.

#### ✧ Questionnaire analysis

The goal of this questionnaire is to illustrate the relationship between residents' consciousness and the electricity consumption to see whether the residents' consciousness has a good effect in the action of electricity saving. According to the contents of each branch, the questionnaire was divided into seven categories as shown in table 3-10. In this section, we only pick up one question as the representative to make a comprehensive analysis.

Table 3-9 Questionnaire results of Group AB and Group C

Items	Group AB	Group C
Total Number	120	70
Participants Number	47	27
Participation Rate	39.2%	38.6%
Effective Number	43	25
Effective Rate	91.5%	92.6%

Table 3-10 Contents classification of questionnaire

I	Aspect of the utilization of the smart meter
II	Aspect of the DP price with consciousness of energy saving
III	Aspect of the DP price with action of saving electricity
IV	Aspect of the menu of electricity price
V	Aspect of the monthly electricity charge
VI	Aspect of the feelings about energy saving
VII	Aspect of the relationship between health and purpose of energy saving

**CHAPTER THREE: EXPLORATORY ANALYSIS OF KITAKYUSHU RESIDENTS  
RESPONSE TO DYNAMIC ELECTRICITY PRICING**

Table 3-11 shows the information of selected question: “In order to confirm the enablement of DP, how often did you see the smart meter indoors during the DP implementation.” There are five different branches from positive side to negative side (several times per day; once per day; several times per week; once just at the beginning; never see). Table 3-11 also reveals that the residents who see the smart meter once just at the beginning have taken the biggest proportion compared to other four branches, accounts for 28.6%, followed by see the smart meter once per day (23.8%), several times per day (19%), several times per week(19%) and never see (9.6%). It is obvious that most consumers have the high consciousness at the beginning of the DP implement. They were interested in seeing smart meter once DP was introduced into their house, however, that interest will disappear as time goes on.

In order to compare the electricity consumption of each consumer group with different options, we calculated the percentage of electricity consumption which in DP time accounts for that in whole day in 2012 summer and winter. Figure 3-42 and figure 3-43 presents the results. As anticipated, along with the change of residents' consciousness from positive to negative, the electricity consumption during the DP period has an increasing trend. The electricity consumption of consumers who see smart meter several times per day is the highest and the electricity consumption of consumers who never see smart meter is the lowest. It tells us the awareness of residents could make a good influence on the aspect of utilization of DP.

Table 3-11 Information of selected question

Question 1: In order to confirm the enablement of DP, how often did you see the smart meter indoors during the DP implementation?			
		Household Number	Percentage
Option 1	Several times per day	8	19%
Option 2	Once per day	10	23.8%
Option 3	Several times per week	8	19%
Option 4	Once just at the beginning	12	28.6%
Option 5	Never see	4	9.6%

CHAPTER THREE: EXPLORATORY ANALYSIS OF KITAKYUSHU RESIDENTS  
RESPONSE TO DYNAMIC ELECTRICITY PRICING

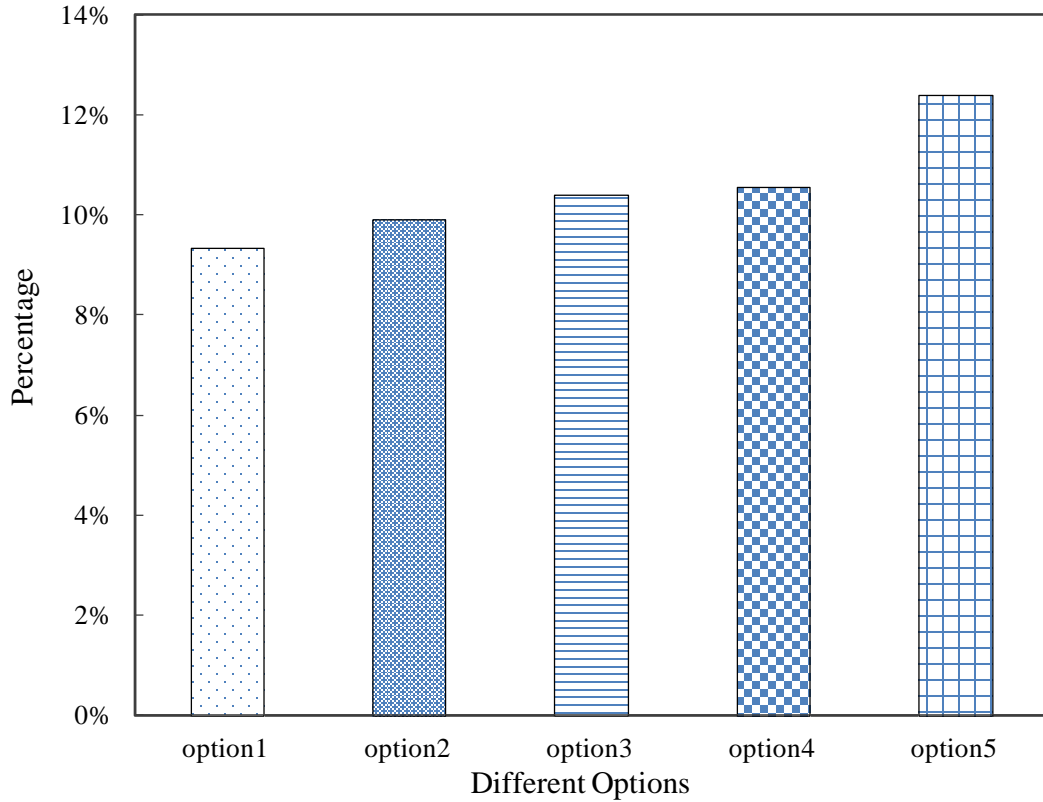

Figure 3-42 Electricity consumption in DP time accounts for that in whole day in 2012 summer

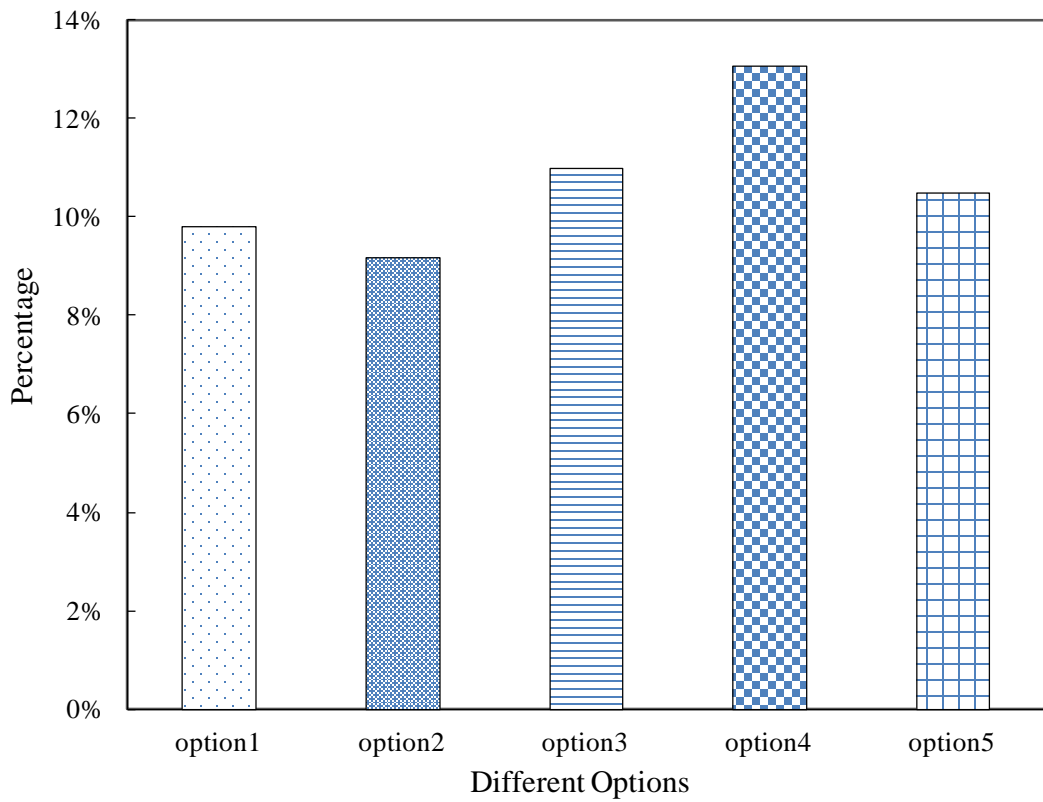

Figure 3-43 Electricity consumption in DP time accounts for that in whole day in 2012 winter

## CHAPTER THREE: EXPLORATORY ANALYSIS OF KITAKYUSHU RESIDENTS RESPONSE TO DYNAMIC ELECTRICITY PRICING

### 3.5 Summary

This chapter investigates the characteristic of Japanese dynamic pricing (DP) model, taken Kitakyushu smart community as an example, the construction of five-level electricity price system were introduced carefully. Meanwhile, it summarizes the results from an exploratory analysis of about 200 households that took part in DP experiment in Kitakyushu, Japan. Through analyzing hourly load data collected from smart meter, this part calculates the energy consumption of target residential consumers, found that the year electricity consumption mode of DP group and non-DP group in four years (from 2010 to 2013) is almost same, except the tiny value difference. In addition, the hourly electricity consumption reveals that dynamic pricing was appropriately performed in the reduction of electricity load during peak/event period, besides, outside the event period, the difference between usage values on normal and critical days is negligible. This chapter also discusses dynamic electricity pricing effect influenced by various factors, such as temperature, floor area of households, price level and residential consciousness. It has four major findings. Firstly, dynamic pricing was appropriately performed in the reduction of electricity load during peak period whether in summer or winter. Residential customers have the potential to respond to variable price signals. Secondly, the load reduction is tightly related to temperature. The size of load reduction is the largest during extreme temperature which indicating that the important part of load reduction are space heating and cooling. Thirdly, different levels of electricity price have different ability to decrease the peak load. The better dynamic pricing effect appears in higher price level. Finally, the awareness of residents could make a good influence on the aspect of utilization of DP, the electricity consumption of consumers that with high energy-saving consciousness is usually higher than that with low energy-saving consciousness.

## CHAPTER THREE: EXPLORATORY ANALYSIS OF KITAKYUSHU RESIDENTS RESPONSE TO DYNAMIC ELECTRICITY PRICING

### REFERENCE

- [1] IRED Side event iiESI Asian Workshop, “JAPAN’s Energy Situation”. November 17, 2014.
- [2] The Agency for Natural Resources and Energy, “Comprehensive Energy Statistics”.
- [3] Japanese Government (2010), New Growth Strategy,  
<http://www.kantei.go.jp/jp/sinseichousenryaku/sinseichou01.pdf#search='%E6%94%BF%E5%BA%9C%E3%81%AE%E6%96%B0%E6%88%90%E9%95%B7%E6%88%A6%E7%95%A5'>
- [4] New Energy and Industrial Technology Development Organization (NEDO), “NEDO Smart Community Projects”. April 29, 2015.
- [5] Tadahiro Goda, Kyushu University, “Development and Standardization of Smart Grid and Smart Community in Japan”. December 10, 2012.
- [6] Toyozo Sasakura, Fuji Electric Co., Ltd. “Result of the Kitakyushu Smart Community Creation Project”. June 18, 2015.
- [7] Daphne Ngar-yin Mah, Johannes Marinus van der Vleuten, Peter hills, Julia Tao. “Consumer perceptions of smart grid development: Results of a Hong Kong survey and policy implications”. Energy policy. 21 July 2012.

## **CHAPTER FOUR: EXPLORATORY ANALYSIS OF KITAKYUSHU OFFICES RESPONSE TO DYNAMIC ELECTRICITY PRICING**

### 4.1 Introduction

### 4.2 Database of Offices in Kitakyushu Smart Community Project

#### 4.2.1 Basic information of the project

#### 4.2.2 Information of office group in the project

#### 4.2.3 Electricity pricing system of offices in the project

### 4.3 Energy Consumption of the Target Offices

#### 4.3.1 Energy Consumption in Complex Commercial Building

#### 4.3.2 Energy Consumption in Office

#### 4.3.3 Energy Consumption in Retail store

#### 4.3.4 Energy Consumption in Manufacturing Industry

#### 4.3.5 Energy Consumption in Medical & Social Welfare

#### 4.3.6 Energy Consumption in Education Support Facility

### 4.4 Evaluation of Offices Response to Dynamic Electricity Pricing

#### 4.4.1 Dynamic electricity pricing effect related to temperature

#### 4.4.2 Dynamic electricity pricing effect related to standard baseline

#### 4.4.3 Dynamic electricity pricing effect related to people's consciousness

### 4.5 Summary





## CHAPTER FOUR: EXPLORATORY ANALYSIS OF KITAKYUSHU OFFICES RESPONSE TO DYNAMIC ELECTRICITY PRICING

### 4.1 Introduction

In the aftermath of the Great East Japan Earthquake that struck on March 11, 2011, and the subsequent nuclear power plant accident, people requires even more demand for "resilience" in this day and age. Energy saving was dramatically required to avoid the supply shortages during the peak period in summer and winter. Demand response as one of the effective means for saving energy has attracted widely attention. Demand response is a change in the power consumption of an electric utility customer to better match the demand for power with the supply. It provides an opportunity for consumers to play a significant role in the operation of the electric grid by reducing or shifting their electricity usage during peak periods in response to time-based rates or other forms of financial incentives. Utilities may signal demand requests to their customers in a variety of ways, most common one is using dynamic pricing.

As evidence of the dynamic price progress, several demonstration projects or initiatives have been developed in the last years by various countries. The Higata district of Kitakyushu city was selected as "Next Generation Social System Demonstration Project" in 2010, and it was implemented until 2015 as "Kitakyushu Smart Community Creation Project". It is one of the four smart community (SC) creation projects implemented by the Ministry of Economy, Trade and Industry. All the projects is aiming at enabling substantial CO2 reductions and energy savings, meanwhile, realizing the stabilized supply of energy. As for the Kitakyushu Yahatahigashi area, smart meters are installed in 225 households for low-voltage use and 50 offices for high-voltage use in that district. Meanwhile, dynamic pricing was introduced to these target consumers.

As for dynamic pricing issues of general households, in order to evaluate the effect of dynamic pricing, the randomized controlled trials were used to divide the participating households into two different groups (with DP and without DP). Due to the sample had about 190 households involved, therefore, the peak cutting effect of DP can be accurately measured. In the previous research which conducted by the Technical Research Association Kitakyushu Smart Community Promotion Organization (KSCoP) and other academic groups, researchers all focused on the analysis of the dynamic pricing effect for residential houses and draw the related conclusions. In the chapter three of this paper, it was also revealed that there was a peak cut effect of about 15% against power consumption. As for dynamic pricing issues of offices, since there are few participants in the social demonstration of DP (just about 50 offices), it is not possible to use randomized comparison tests to evaluate the DP effect. Therefore, it is necessary to find the other method to evaluate the DP effect. One considerable method is to estimate the baseline of power consumption in the case where DP was not implemented and compare it to the power consumption when DP was actually activated.

This chapter selects some kinds of office buildings as a representative aims to introduce the characteristic of Japanese dynamic pricing (DP) model of office side. Moreover, it investigates the energy consumption of target office building. Using hourly load data collected from smart meter and baseline calculating method, it estimates the effect of dynamic pricing system on the energy saving of office, concludes the load reduction for participants during the DP time block. In addition, this paper also discusses the situation of demand response of office customers according to the related questionnaire made by Kitakyushu city.

## 4.2 Database of Offices in Kitakyushu Smart Community Project

### 4.2.1 Basic information of the project

Kitakyushu smart community located in Yahatahigashi area. It is the demonstration area which focuses on creating an environment-friendly and energy saving district. The objective of this project is to realize 20% energy saving effect and reduce 50% CO<sub>2</sub> emissions which compared to other typical block in the city. Figure 4-1 is main features of Kitakyushu Smart Community Project. There are three important branches, local power generation, participation of consumers and linkage with large-scale system. Through the community energy management system, the coordination of those three branched and other sustainable items (Fuel cell, Generation using waste heat, wind and PV generation, power storage system) becomes feasible. The CEMS plays the role of commander to control the energy consumption in the region.

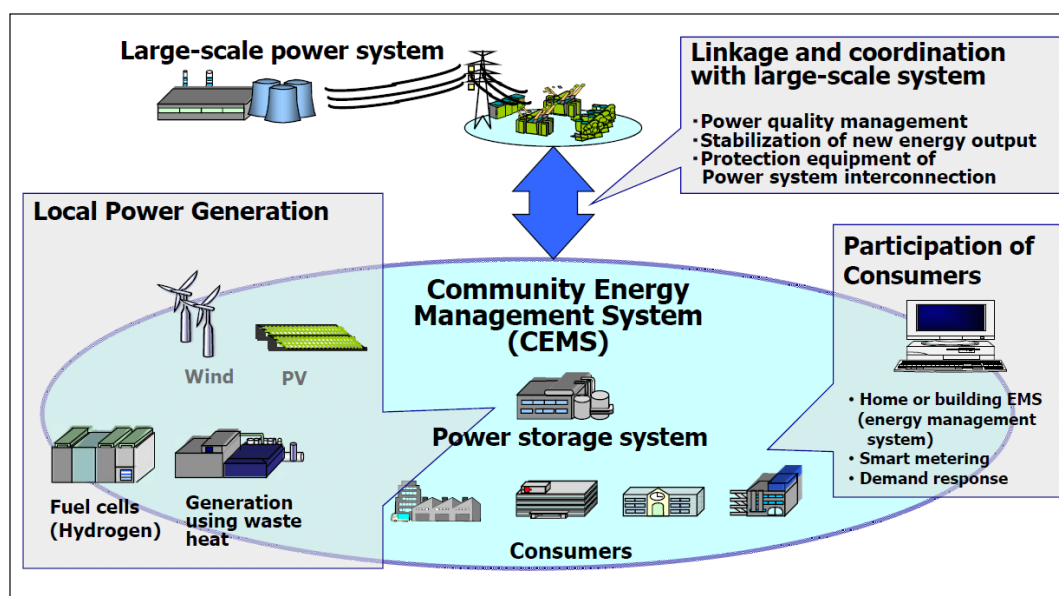

Figure 4-1 Features of Kitakyushu Smart Community Project

(Source: Smart community in Japan, Fuji Electric, 2015.)

The detailed features of Kitakyushu Smart Community Project can be concluded into five aspects:

- (1) Regional supply from the power source independent from large-scale power system. This is also common in other Asian smart community. The regional energy supply system had promoted the development of smart grid which enable the coexistence of both distributed energy and utility grid.
- (2) Realize the practical use of unused energy including factory waste heat. Kitakyushu Higashida area have many industries, the management of its waste heat is essential to the energy saving and environmental protection.
- (3) Use of renewable and clean energy. The introduction of both hydrogen energy and solar energy is meaningful to the CO<sub>2</sub> reduction in the target area.
- (4) Enable consumers take part in the regional energy management system. Users can control their daily activities and lifestyle to response to the energy signals which sent by CEMS, achieving the two-way communication.
- (5) Verification of smart metering and demand response. These two methods can strongly improve the energy efficiency. Figure 4-2 presents the energy visualization of smart management.

## CHAPTER FOUR: EXPLORATORY ANALYSIS OF KITAKYUSHU OFFICES RESPONSE TO DYNAMIC ELECTRICITY PRICING

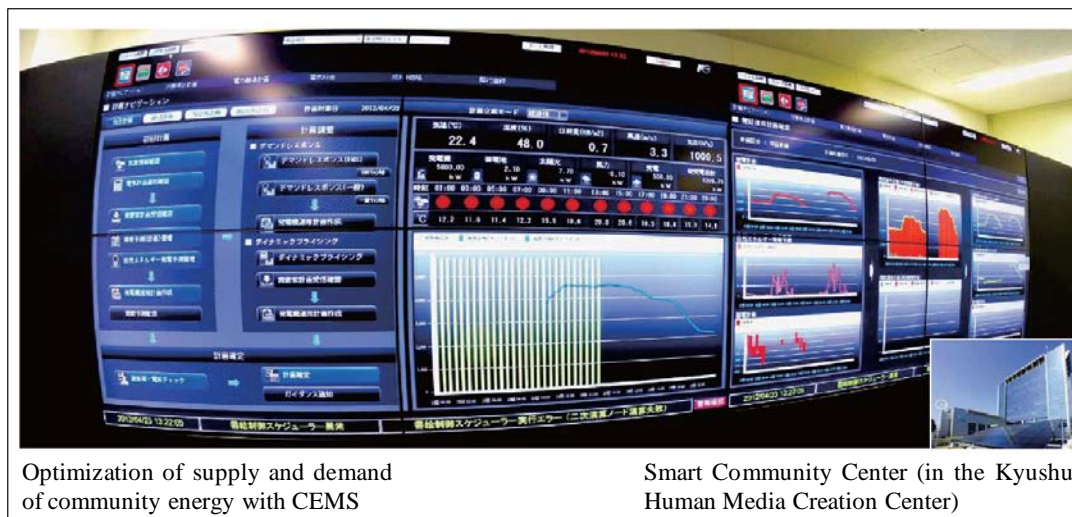

Figure 4-2 Energy Visualization of Smart Management

(Source: Office for Environmental Future City Promotion, Kitakyushu)

### 4.2.2 Information of office group in the project

DP of the Kitakyushu Smart Community Project was largely divided into residential DP and offices oriented DP. About 200 households in the Higashida district participated in the demonstration experiment, of which 120 household groups actually activated DP, and the remaining household groups had applied conventional electricity unit price. Meanwhile, about 50 offices in the Higashida area had participated in the DP experiment.

Higashida area is a commercial and industrial zone which includes the Yahashida Steel Works, Inochi no Tabi Museum (Kitakyushu Museum of Natural History & Human History), Kitakyushu Innovation Gallery & Studio, Yahata Hospital, Eon Shopping mall, Kitakyushu Environment Museum and so on. Various office buildings in the project area have supported the modernization in Kitakyushu model city for green growth. Under this background, the energy management in this kind of district is an important issue for establishing its ecological footprint.

Implementation of DP for offices sites began on August 1, 2012. 46 business sites have taken part in the DP demonstration experiment, including commercial facilities, offices, hospitals, hotels, employee dormitories, factories and public facilities. EMS (energy management system) was introduced to nine of them, and others were equipped with smart meters or other mechanisms that can check power usage and dynamic pricing event situation. Unlike households, the size and form of each office is totally different, such as commercial facilities and convenience stores. Therefore, all the participating targets were divided into seven categories. Table 4-1 shows the grouping information of offices in the project.

Table 4-1 Information of offices

Group	Categories	Number
A	Complex commercial building	1
B	Office	18
C	Retail store	9
D	Manufacturing industry	5
E	Medical & social welfare	3
F	Education support facility	3
G	Others	6

### 4.2.3 Electricity pricing system of offices in the project

Figure 4-3 shows the mechanism of DP in office. The target power demand tends to leveling, while the predicted power demand has the peak and valley. When the electricity load curve appears peak, we need to take actions to restrain the electricity consumption. When the electricity load curve appears valley, we need to take actions to encourage the electricity consumption

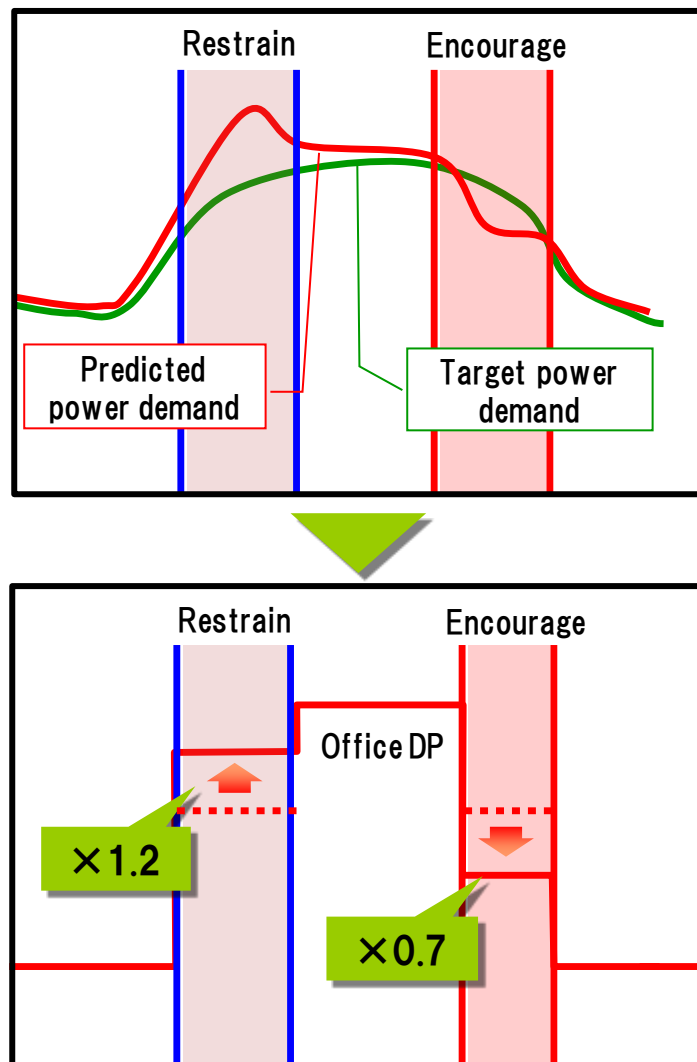

Figure 4-3 Mechanism of Dynamic Pricing in office

According to the actual situation, two kinds of pricing methods were designed for the target offices, one aims to restrain the electricity consumption, another one is to encourage the electricity consumption. Both of two pricing methods contribute to the load leveling through increase or decrease electricity price in critical time block. Actually, 13 specific pricing systems were provided for each office, but level 2 and level 6 were not implemented in real days, therefore, the illustration of them were not shown in the figure. In addition, dynamic price only been implemented when the highest temperature forecast exceeds 30 °C for summer or the lowest temperature forecast between -1 °C and 9 °C for winter.

Figure 4-4 and figure 4-5 show the detailed information of DP in offices. The Higashida version seasonal electricity price is multiplied by the coefficient of 1 to 1.5 (sometimes 2, 3 in some cases) in a time zone in which it is anticipated to restrain electricity consumption after power demand forecast, and multiplied by the coefficient of 0.7 to 1 in the time zone in which electricity

**CHAPTER FOUR: EXPLORATORY ANALYSIS OF KITAKYUSHU OFFICES  
RESPONSE TO DYNAMIC ELECTRICITY PRICING**

consumption is desired to be encouraged. Therefore, the dynamic pricing system of offices was built through this kind of mechanism. The notice of detailed price change which aimed to realizing load leveling was carried out twice. One is after 14 o'clock in the yesterday, another one is after 6 o'clock in the morning of the day. During peak time period from 1 pm to 5 pm, the experiment set a difference of up to 10 times of the electricity fee from Level 1 (15 JPY/ kWh) to Level 9 (150 JPY/kWh).

In this chapter, we use the hourly data collected from smart meter to analysis the effect of DP. The time period that we use to analyze DP effect is summer and winter in 2012 and 2013, respectively. Table 4-2 is the number of the dynamic pricing implement days in different level price for offices. It is obvious that DP had been event 35 days in 2012 summer, 24 days in 2012 winter, 17 days in 2013 summer and 30 days in 2013 winter respectively. The number of DP days in different price levels is also different. There are 21 days and 23 days for level 2 and level 7, 13 days for level 3 and lower than 10days for other types of levels.

Table 4-2 Number of the DP implement days in different level

Level	level 1	level 2	level 3	level 4	level 5	level 6	level 7	level 8	level 9	Total
2012summer	8	0	7	0	9	0	7	3	1	35
2012winter	3	4	6	4	0	7	0	0	0	24
2013summer	0	0	0	0	0	0	7	5	5	17
2013winter	0	17	0	4	0	0	9	0	0	30
Total	11	21	13	8	9	7	23	8	6	106

CHAPTER FOUR: EXPLORATORY ANALYSIS OF KITAKYUSHU OFFICES  
 RESPONSE TO DYNAMIC ELECTRICITY PRICING

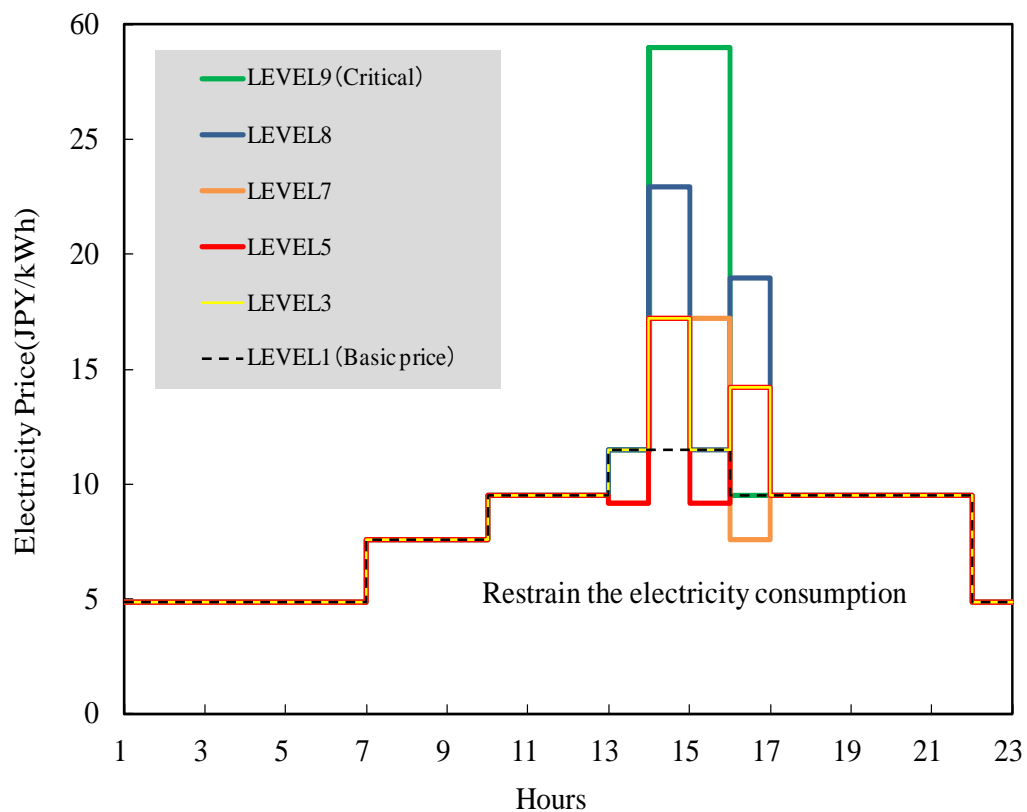

Figure 4-4 Dynamic electricity pricing in office (Restrain the electricity consumption)

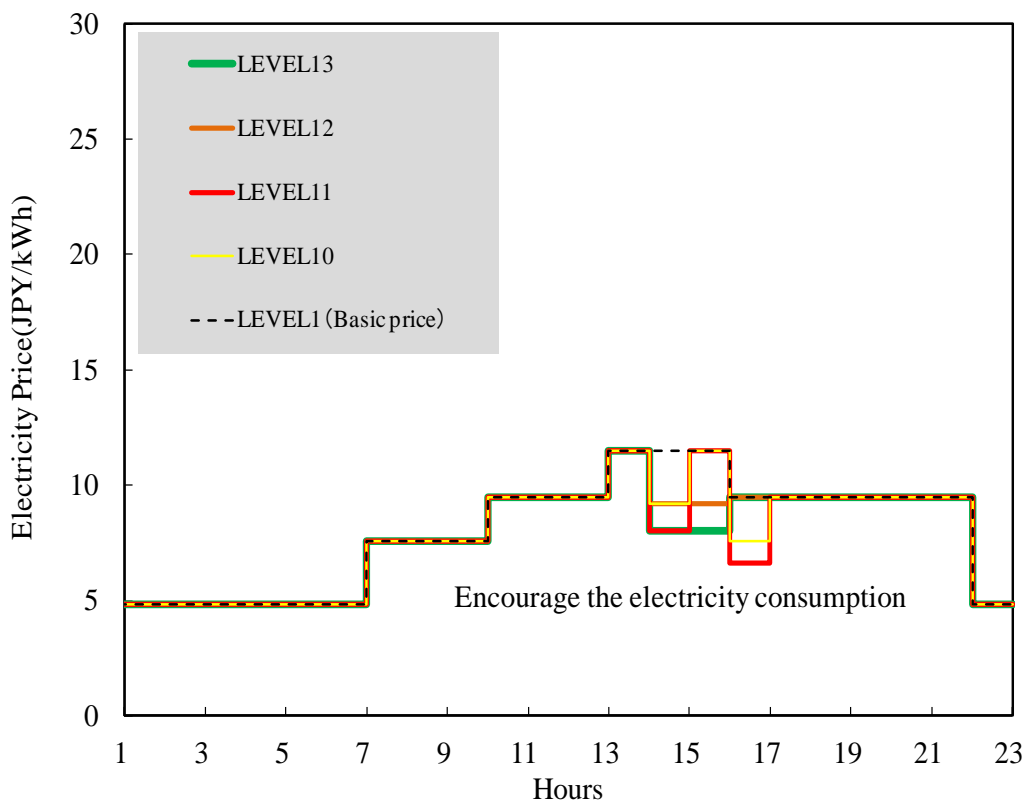

Figure 4-5 Dynamic electricity pricing in office (Encourage the electricity consumption)

### **4.3 Energy Consumption of the Target Offices**

As for the investigation method of energy consumption in target offices, this part provides three directions to do the discussion:

#### **(1) Investigation of the hourly electricity consumption**

First, in order to investigate the tendency of electricity consumption, the hourly electricity load of different office category in summer and winter was summarized. In this section, we select the data for August in summer and January in winter (setting DP most frequently) to see the electricity consumption situation in DP event time. As for the related graph in this part, the vertical axis represents the average value of hourly electricity consumption in weekday, and the horizontal axis represents the time.

#### **(2) Investigation of the monthly electricity consumption**

Next, the comparison of monthly total electricity consumption in four years (FY2010, FY 2011, FY2012, FY2013) was carried out. Owing to the data was selected from 2010 when two years before DP experiment started, some offices were able to exploring the DP effect of electricity consumption reduction. In addition, with respect to this investigation, it was predicted that there was a tendency of energy saving due to the influence of the Great East Japan Earthquake in March 2011, and based on that, the investigation about that whether further saving effect caused by DP demonstration experiment was also can concluded. As for the related graph in this part, the vertical axis shows the monthly electricity consumption and the horizontal axis the month.

#### **(3) Investigation of the relation between the electricity consumption and temperature**

Finally, the relation between the electricity consumption and temperature in the peak time on DP event day and DP no event day was investigated. DP was often set on the day when the temperature is really high and the electricity demand in that time increases accordingly, it is inevitable that the total electricity consumption will also increases. Therefore, just consider the electricity consumption to evaluate the energy saving effect of DP is not reasonable. Corresponding to this phenomenon, we decided to correct the DP effect result using the temperature.

### **4.3.1 Energy Consumption in Complex Commercial Building**

#### **◇ Group A:**

The target building of Group A is one complex commercial facility with a total floor area of 67,500 m<sup>2</sup>. The building houses about 150 small retails stores and a large scale supermarket, as well as a food court which results in the diverse and huge electricity usage. The daily hours of business are 10 AM till 10 PM, except for some days when the store is closed.

Figure 4-6 shows the hourly electricity consumption of group A. From the figure, we can confirm the change of the electricity consumption of complex commercial building on one day. The following two results can be concluded. ① Electricity consumption at night is stable with a nearly constant value, some parts is owing to the refrigeration needs from the food stores, and the remainder is taken up by power for lighting. ② Electricity consumption rises rapidly from one hour before the business start time. It is clear that the peak period of electricity using for commercial building is from 9:00 to 21:00 which is tightly related to its working hour. The electricity consumption of group A is almost flat during the working hours.

Figure 4-7 gives us the illustration about the monthly electricity consumption of target commercial building. We recognized the time period from April to March of next year as a whole year due to the smart meter starts to collect data from April, 2012. Here, summer includes June,

## CHAPTER FOUR: EXPLORATORY ANALYSIS OF KITAKYUSHU OFFICES RESPONSE TO DYNAMIC ELECTRICITY PRICING

July, August and September. Winter includes December, January, February and March. The electricity demand and consumption show distinct seasonal variations. As was presumable, the electricity consumption peaks during the summer period due to the hot summer months and the air-conditioning needs. During the mid-season the electricity consumption is also high due to the high internal loads, such as people, office but mainly the thermal loads from the artificial light. Besides, it is obvious that the electricity consumption of 2012 and 2013 is lower than that of 2010 and 2011, which due to the energy saving actions after the Great East Japan Earthquake. Furthermore, from Figure 4-7, it also revealed us that July and August have the largest electricity consumption throughout the year, and a decrease in electricity consumption of 18.9% can be confirmed from 2010 to 2013. The reason for the large amount of electricity consumption in July and August can be concluded to be an increase in electricity usage due to the frequently use of air-conditioning equipments as the temperature rises. On the other hand, the declining trend of electricity consumption in the year is due to improvements in energy conservation management or the impact of LED lighting etc.

The largest electricity consumption in complex commercial building is air-conditioning which is very much weather dependent. Many researches are about climatic influences on both the residential and commercial buildings electricity use indicated that there were significant correlations between electricity consumption and the corresponding temperature data. Linear regression analysis of the electricity consumption and the corresponding outdoor temperature was conducted for Group A. Figure 4-8 and Figure 4-9 presents the relationship between electricity consumption and temperature in 2012. From figure 4-8, there was a significant phenomenon that the higher the temperature was, the higher the electricity consumption. It is owing to that higher temperatures may raise energy demand caused that more energy (in particular, electricity) will be needed to run air conditioners and other cooling devices in the summer. These two figures also indicate that dynamic pricing was appropriately performed in the reduction of electricity load in summer day (the red line represents the trend of electricity consumption in DP event day; the black line represents the trend of electricity consumption in DP no event day). In other words, that is to say, with the incentive of high critical electricity price, the employees of commercial building did some corresponding energy saving actions.

However, as for winter, according to the figure 4-9, we can easily know that the gap between the electricity consumption of DP no event day and DP event day was not increased as the increase of temperature. Actually, the electricity consumption of complex commercial building has no tightly relationship with temperature. Although the temperature in winter is low, but the high customer density and other special characteristics for shopping mall results in that the temperature will not influence the heat demand for complex commercial building seriously. In addition, it was found that air conditioning and electric lighting were the major electricity end uses for the complex commercial buildings, almost accounting for about 85% of the total building energy use. Tenant electricity use was for electric lighting in the shops and retail outlets, consisting mainly of fluorescent tubes, track lights, tungsten halogen lamps and energy saving light bulbs. Lighting density loads and the corresponding electricity consumption varied, depending largely on functional and aesthetic requirements and the trading hours. Lighting load is separately to the temperature. Therefore, the electricity load of complex commercial building is evenly distributed in figure 4-9.



CHAPTER FOUR: EXPLORATORY ANALYSIS OF KITAKYUSHU OFFICES  
 RESPONSE TO DYNAMIC ELECTRICITY PRICING

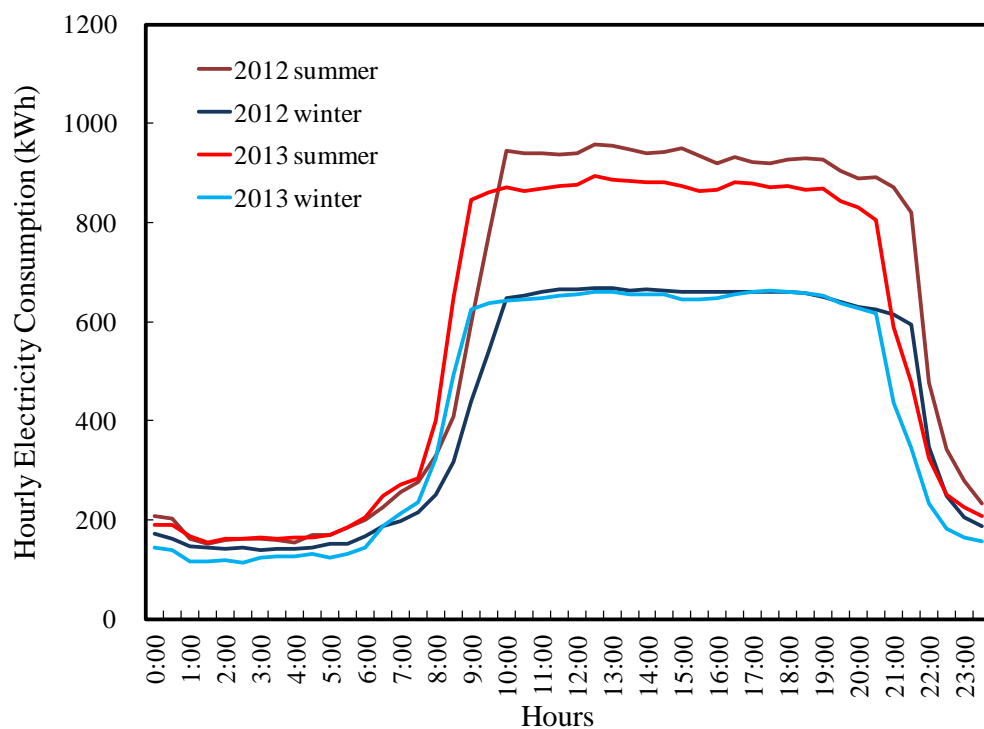

Figure 4-6 Hourly electricity consumption of group A

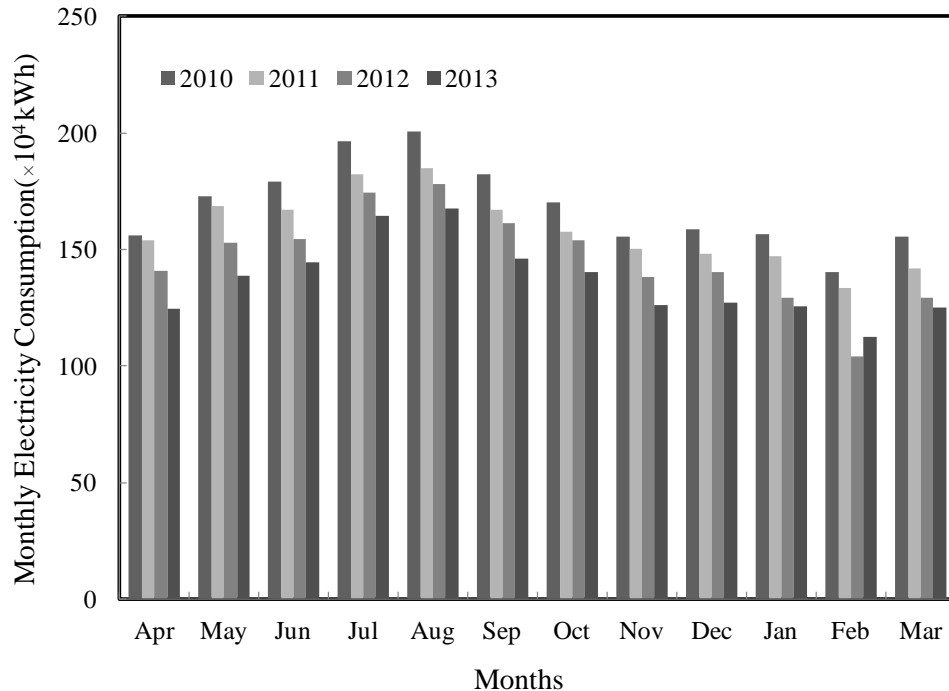

Figure 4-7 Monthly electricity consumption of group A

CHAPTER FOUR: EXPLORATORY ANALYSIS OF KITAKYUSHU OFFICES  
RESPONSE TO DYNAMIC ELECTRICITY PRICING

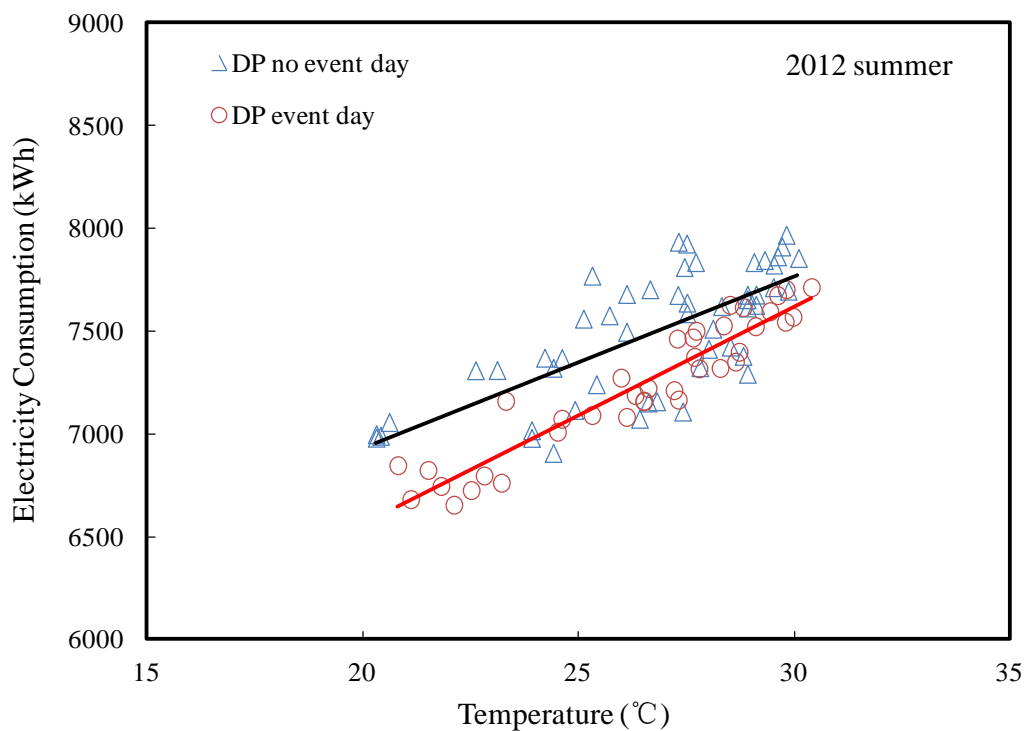

Figure 4-8 Correlations between electricity consumption and temperature in 2012 summer of Group A

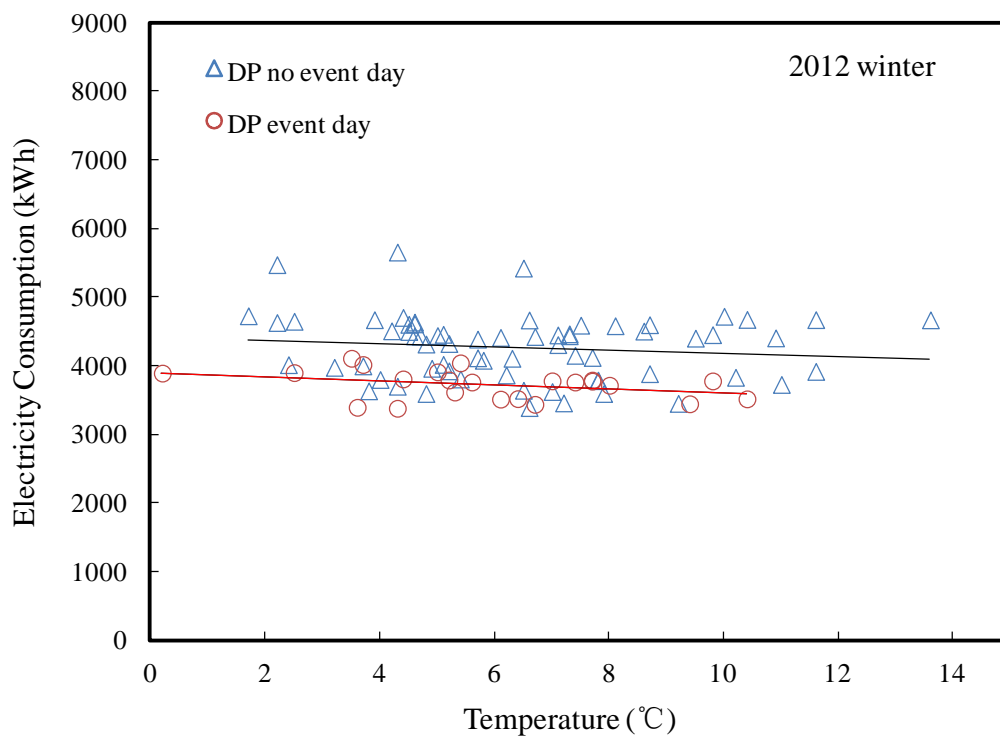

Figure 4-9 Correlations between electricity consumption and temperature in 2012 winter of Group A

### 4.3.2 Energy Consumption in Office Building

#### ◇ Group B:

In the target creation project area, 18 buildings were classified as offices. Using the same method as Group A, we also analyzed the hourly electricity consumption and monthly electricity consumption of Group B.

Figure 4-10 illustrates the hourly electricity consumption of group B. According to the figure, we can know that the peak period of electricity using for office house is from 8:00 to 20:00 which is tightly related to the working hour of office house. Around 12 o' clock, the electricity of office house reached to the maximum. In the other daytime period, the electricity consumption has no obvious difference. In the night time, office house almost have relatively small electricity consumption, owing to the standby power of office equipments and some overtime work of staff in the company.

Figure 4-11 shows the monthly electricity consumption of office houses. In this part, we just list the monthly electricity consumption of offices in 2011, 2012 and 2013, owing to the data missing in 2010. As same as commercial building, the electricity consumption of 2012 is lower than that of 2011, which due to the energy saving actions after the Great East Japan Earthquake. But for 2013, the electricity consumption has almost rebounded to the original level. In addition, it is obvious that the electricity load of office house in summer is much higher than the load in other periods. For the reason that office house usually have many office equipments which can't have good heat dissipation under the hot weather, this will aggravates the indoor temperature environment so that more electricity was need to meet the increased cooling load.

The electricity consumption of air-conditioning is still an essential part in the total electricity consumption as for office building. Due to the temperature is strongly influenced the cooling and heating load of air-conditioning, therefore, it is necessary for us to analyze the relationship between electricity consumption and temperature. Figure 4-12 and figure 4-13 presents the correlations between electricity consumption and temperature in 2012 summer and winter of Group B. It can be known that the electricity consumption of DP event day is higher than that of DP no event day in summer. It mainly conducted by two reasons. One is that global warming results in the extremely high temperature in summer in recent years, and DP is usually be set in such kind of high temperature days. Under this condition, people are not able to change their energy consumption actions when response to DP in the hot summer. The other one is that computers are commonly the single biggest source of energy use in office, and as such, contribute significantly to internal heat gains. In hot summer days, offices which equipped with many computers will make the indoor temperature more unbearable. Consumers must use air-conditioning to drop temperature as usual in DP event day. In winter, the electricity consumption of DP no event day is higher than that of DP event day which proved that DP has some electricity load reduction effect for office building. The heat dissipation from a lot of office equipments provides the possibility to staffs to consume less in winter.

CHAPTER FOUR: EXPLORATORY ANALYSIS OF KITAKYUSHU OFFICES  
RESPONSE TO DYNAMIC ELECTRICITY PRICING

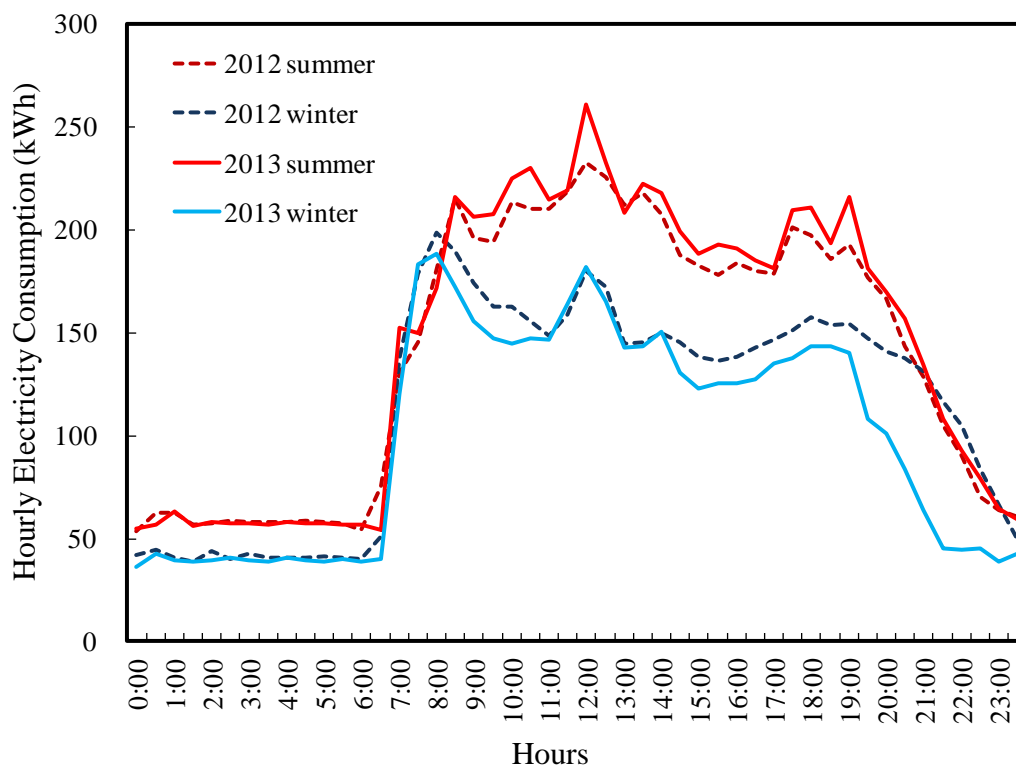

Figure 4-10 Hourly electricity consumption of group B

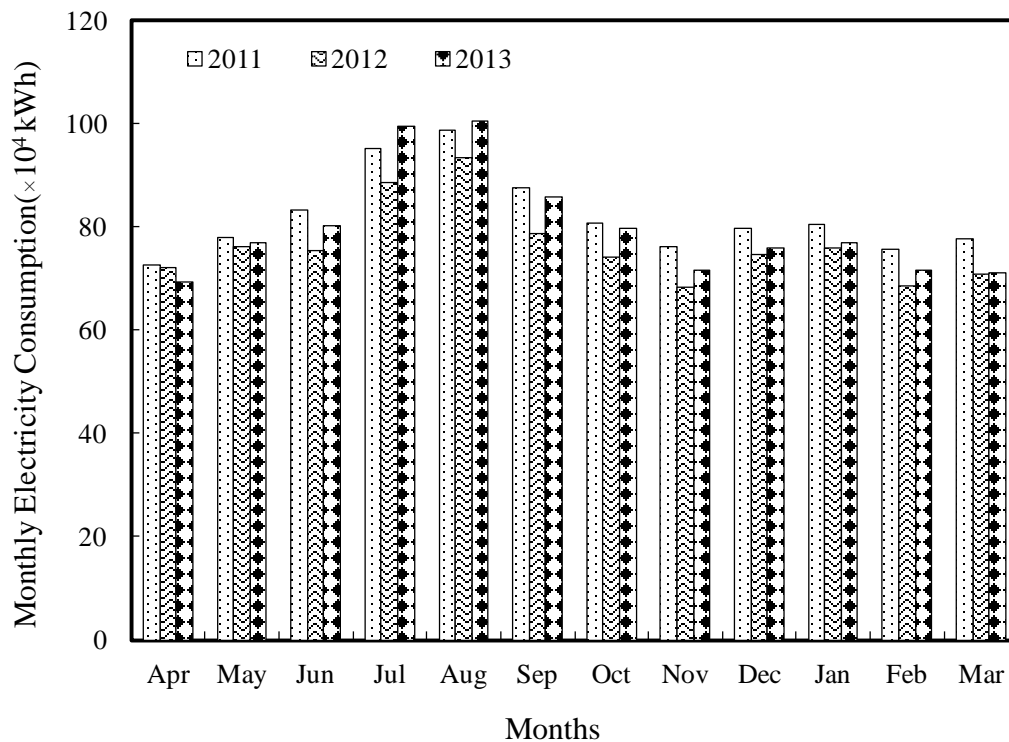

Figure 4-11 Monthly electricity consumption of group B

CHAPTER FOUR: EXPLORATORY ANALYSIS OF KITAKYUSHU OFFICES  
RESPONSE TO DYNAMIC ELECTRICITY PRICING

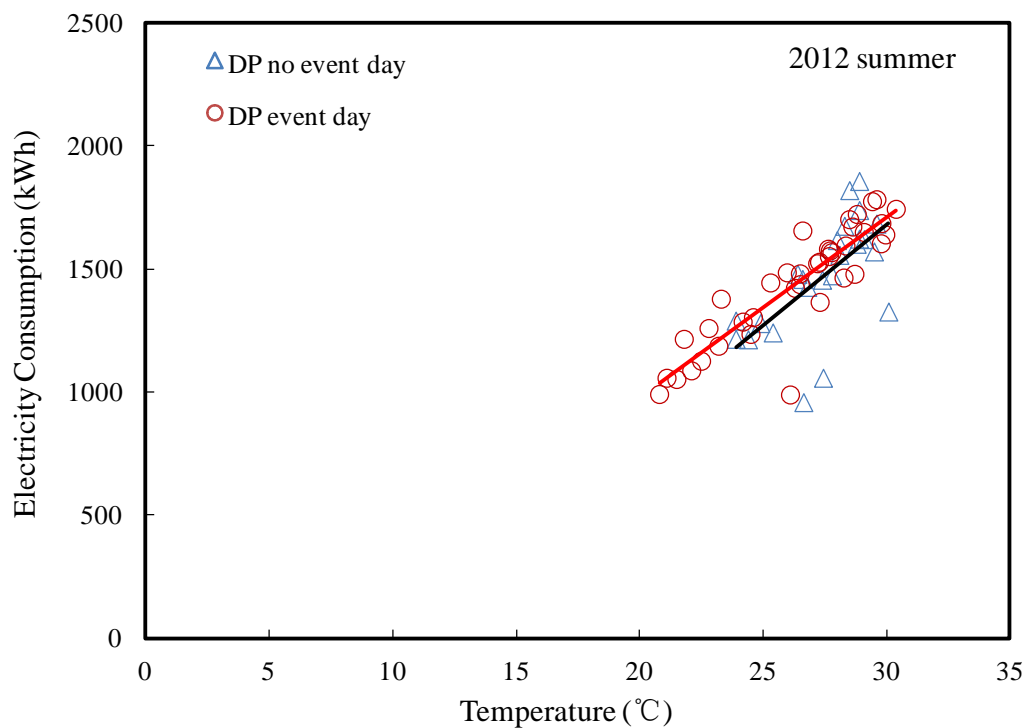

Figure 4-12 Correlations between electricity consumption and temperature  
in 2012 summer of Group B

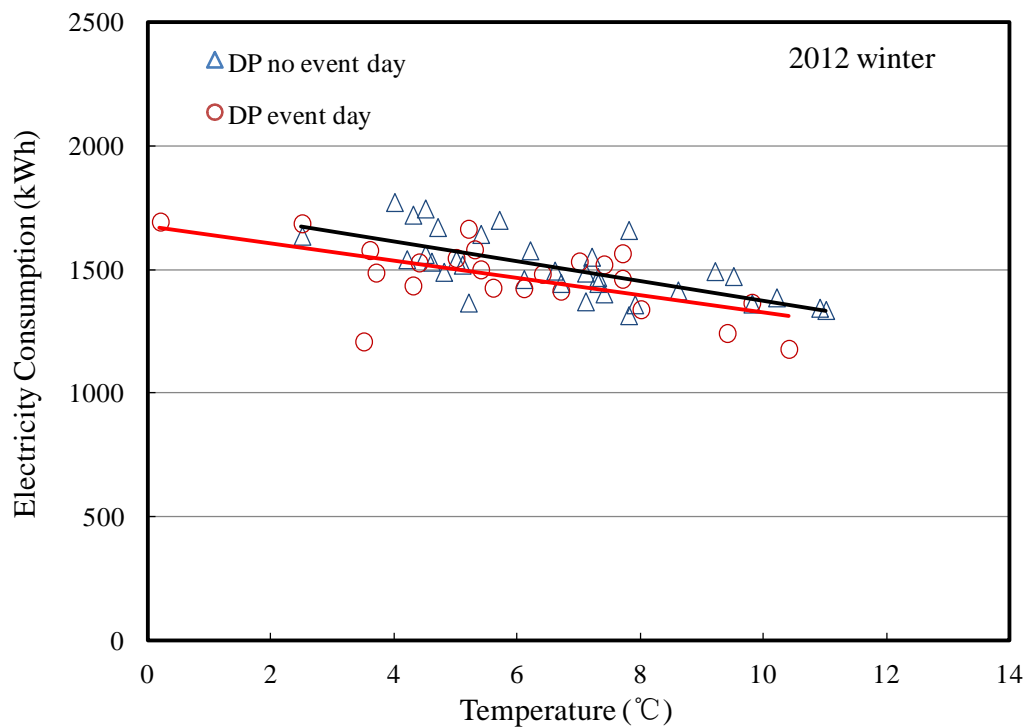

Figure 4-13 Correlations between electricity consumption and temperature  
in 2012 winter of Group B

### 4.3.3 Energy Consumption in Retail store

◇ Group C:

Retail store has a high level of energy consumption due to decorative illumination and refrigerated cabinets. The energy consumption of retail store accounts for approximately 40% of the consumption of Japanese commercial sectors. It is an essential part when people discussing the energy consumption situation in offices buildings. Compared to other kinds of offices, retail store has more refrigeration cases and more intensive activities which will results in great energy consumption. This part provides insight into which aspects of the investigation of the energy consumption in retail store using the half an hour data collected from smart meter.

Retail store usually can be divided into two different parts: food retail stores and non-food retail stores. Figure 4-14 shows the electricity consumptions by end use in food retail stores and non-food retail stores. It is obvious that the refrigeration section has accounts for the largest section in all end users in food retail stores, reached to 48%. While lighting accounts for the largest section in all end users in non-food retail stores which reached to 50%, nearly the half of all energy consumptions. Electricity consumption in retail store were categorized into those of the cabinet and the heat source of refrigeration equipment, those of HVAC and those for lighting and other equipment for analysis. One important factor that has a deep influence on the electricity consumption of retail store is the balance between temperature controlled (refrigerated) and ambient products, as well as the balance between frozen and chilled food products. It caused the high energy density in most of retail stores.

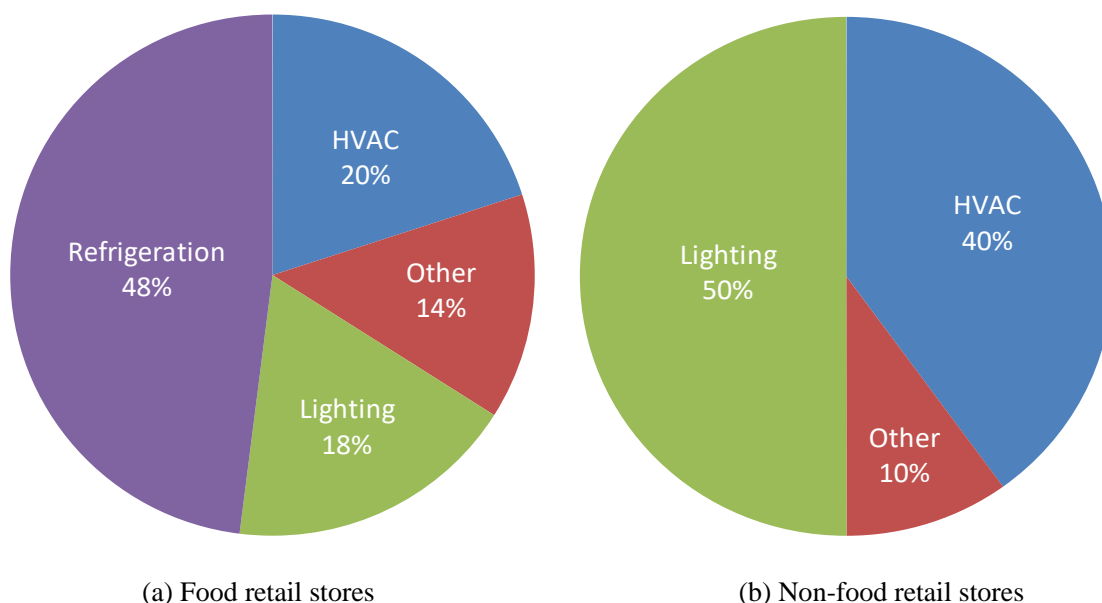

Figure 4-14 Electricity consumptions by end use in retail store

(Source: Schneider Electric audits)

Figure 4-15 presents the electricity consumption situation of group C. The result demonstrates the hourly power consumption in summer and winter. It is easily know that the maximum value of electricity consumption appears in around 19 o'clock. In the whole day, electricity load starts to increase around 9 o'clock in the morning, and then it almost keeps stable until 17 o'clock. The hourly electricity consumption in summer was higher than the one in winter with values of 900 kWh/hour and 800 kWh/hour respectively. There was approximately 100 kWh/hour seasonal

**CHAPTER FOUR: EXPLORATORY ANALYSIS OF KITAKYUSHU OFFICES  
RESPONSE TO DYNAMIC ELECTRICITY PRICING**

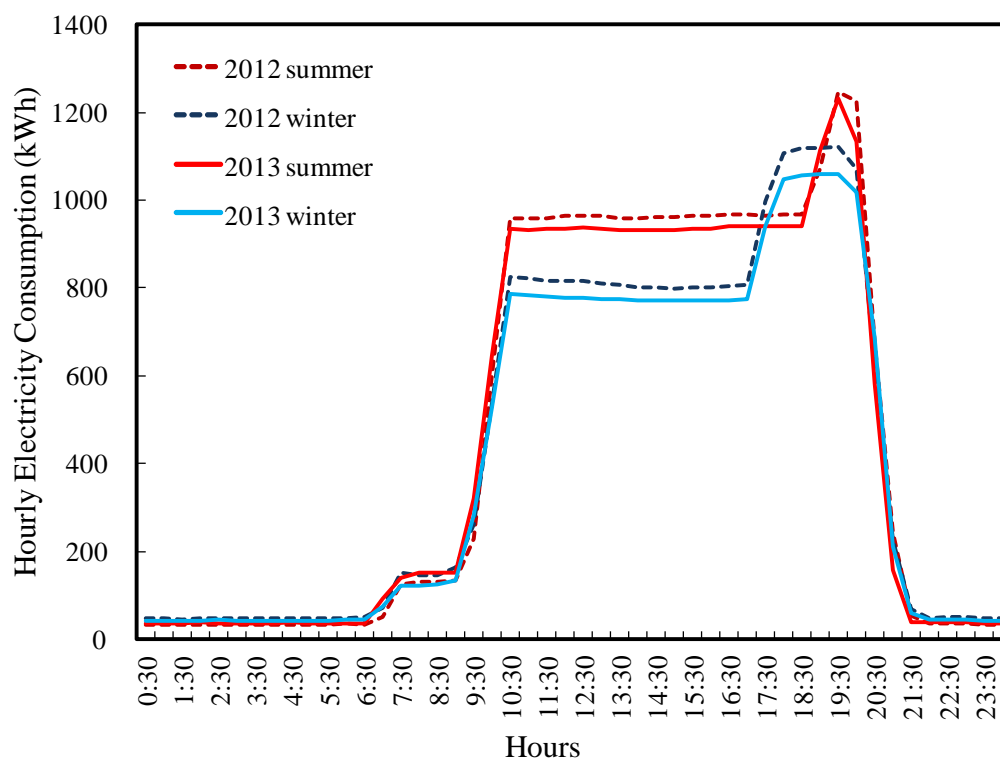

Figure 4-15 Hourly electricity consumption of group C

variation according to the power consumption in retail stores.

Due to the loss in the selecting data of retail store in 2010 and 2011, we are not draw the monthly electricity consumption figure in this part as same as Group A and Group B.

Business activity and temperature are often correlated with energy consumption. For example, retail stores that are open longer hours, have more refrigeration cases, and experience more cooling degree days use more energy, on average. Figure 4-16 and figure 4-17 shows the correlations between electricity consumption and temperature in 2012 summer and winter of Group C. It is obvious that the electricity consumption of DP event day is higher than that of DP no event day in summer. Even in winter, DP also has no conspicuous electricity consumption reduction effect. The most important reason is that the properties of retail store decide they are not able to do corresponding energy saving actions when response to DP. Actually, retail store is a kind of service industry, the benefit and comfort of customer is prior to everything. If they turn the temperature of air-conditioning higher, it will gives customer an unpleasant shopping experience. Therefore, it is difficult to change the energy consumption mode in order to decrease its energy consumption. The other important reason which results in this phenomenon is that retail store usually has many cooling equipments to make sure the food fresh. In addition, the electricity consumption of this part takes a large percentage in the whole energy consumption and not able to change.

CHAPTER FOUR: EXPLORATORY ANALYSIS OF KITAKYUSHU OFFICES  
RESPONSE TO DYNAMIC ELECTRICITY PRICING

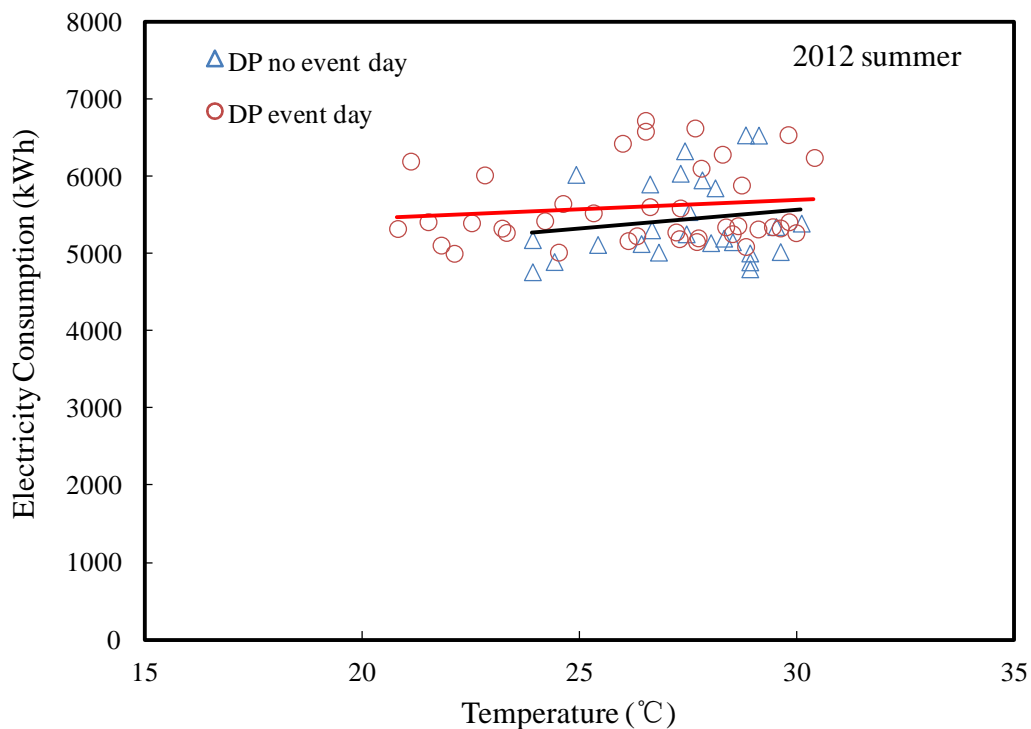

Figure 4-16 Correlations between electricity consumption and temperature  
in 2012 summer of Group C

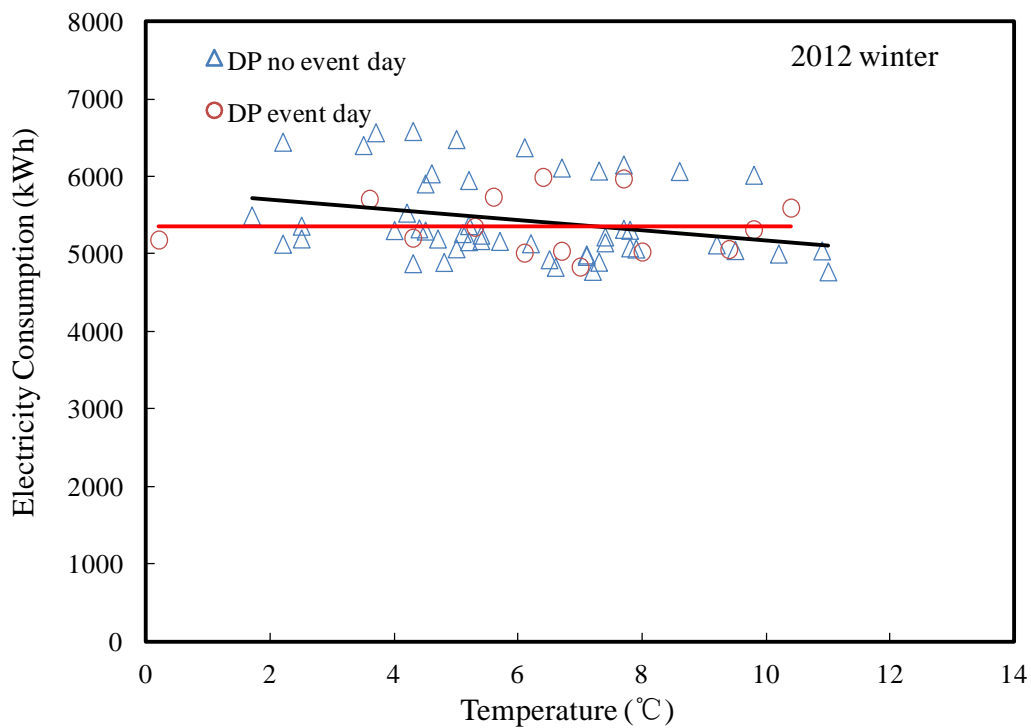

Figure 4-17 Correlations between electricity consumption and temperature  
in 2012 winter of Group C



### 4.3.4 Energy Consumption in Manufacturing Industry

◇ Group D:

The appearance of industrialization boosts the development of economies of many countries. People have put their emphasis on making production efficient, reliable and cheaper, worldwide. The study shows that most of electricity consumption of industries can be allocated to a few applications. The dominant applications are compressed air systems, pumping systems and air conditioning systems.

In this paper, we also categorized several manufacturing industries from about 50 target offices. However, it is difficult to conclude the electricity consumption mode of these manufacturing industries owing to the area of them is much different. Therefore, we just select one office which be classified to manufacturing industry to show its electricity consumption situation. It can't represent all of this kind of offices.

Figure 4-18 illustrates the electricity consumption situation of group D in two years. It is the same with other office group, the electricity consumption in 2013 is lower than that in 2012 due to the influence of temperature. The result demonstrates the hourly power consumption in summer and winter. As shown in the figure, the electricity consumption is strongly related to the working hour of factories which start from about 7 o'clock or 8 o'clock, finish at 19 o'clock or 20 o'clock. One most obvious characteristic of electricity consumption curve is that there is a drop around 12 o'clock. It is mainly owing to the lunch time and break time in the noon for factory workers. In the night, the electricity consumption for the manufacturing industry is still not zero. As for the case of this office which we selected, the night electricity consumption of it reached to 100kWh in 2012 and 50kWh in 2013.

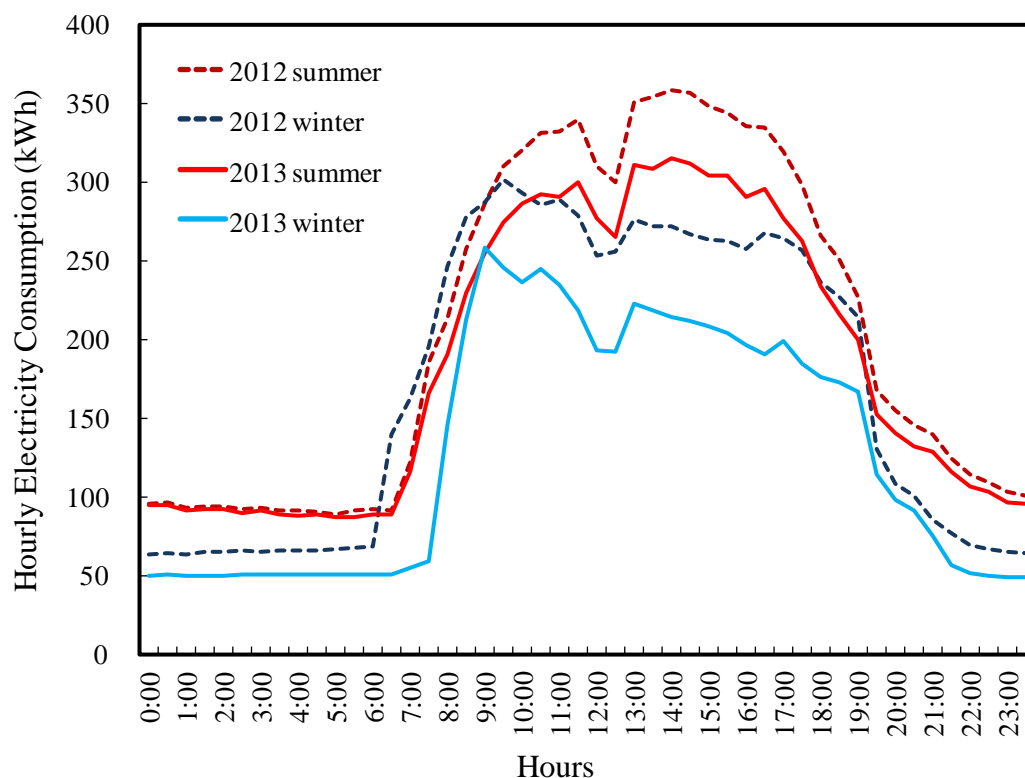

Figure 4-18 Hourly electricity consumption of group D

## CHAPTER FOUR: EXPLORATORY ANALYSIS OF KITAKYUSHU OFFICES RESPONSE TO DYNAMIC ELECTRICITY PRICING

Like offices of group C, we are also not draw the monthly electricity consumption figure in this part as same as Group A and Group B. Because of that we loss the electricity consumption data which need to select in 2010 and 2011.

The link between temperature and energy consumption is rather intuitive. Higher temperatures may raise energy demand caused that more energy (in particular, electricity) will be needed to run air conditioners and other cooling devices in the summer. Lower temperatures still may increase the energy consumption due to the more energy resources will be needed for heating purposes in the winter season. Therefore, it is necessary to investigate the influence of temperature factor on the electricity consumption of offices. Linear regression analysis of the electricity consumption and the corresponding outdoor temperature was also conducted for Group D. Figure 4-19 and Figure 4-20 presents the relationship between electricity consumption and temperature in 2012 for group D. According to figure 4-19, there was a significant phenomenon that the higher temperature results in the higher electricity consumption. In most of manufacturing industries, power machines have be equipped to make sure the smooth progress of production. And this section usually accounts for a large proportion of electricity consumption. In hot summer, power machines will consume more when working at such a condition with extremely high temperature. However, as for winter, the relationship between temperature and energy consumption is not so obvious. As shown in figure 4-20, the distribution of electricity consumption of group D is almost evenly scattered. Although the temperature in winter is low, the exhaust from the power machine and production process will help manufacturing industry to decrease its heating load in winter.

In addition, DP has no obvious effect in reducing electricity consumption in peak time period. From figure 4-19 and figure 4-20, it can be found that the electricity consumption of DP event day is almost higher than that of DP no event day whether in summer or winter. The most important reason is that the production line of manufacturing industry is fixed. If factory adjusts its electricity consumption mode to response to DP, it will interrupt the normal production process and lead to huge economic losses. Therefore, as for manufacturing industry, it is difficult to change its energy consumption mode in order to decrease its energy consumption during DP time.

CHAPTER FOUR: EXPLORATORY ANALYSIS OF KITAKYUSHU OFFICES  
RESPONSE TO DYNAMIC ELECTRICITY PRICING

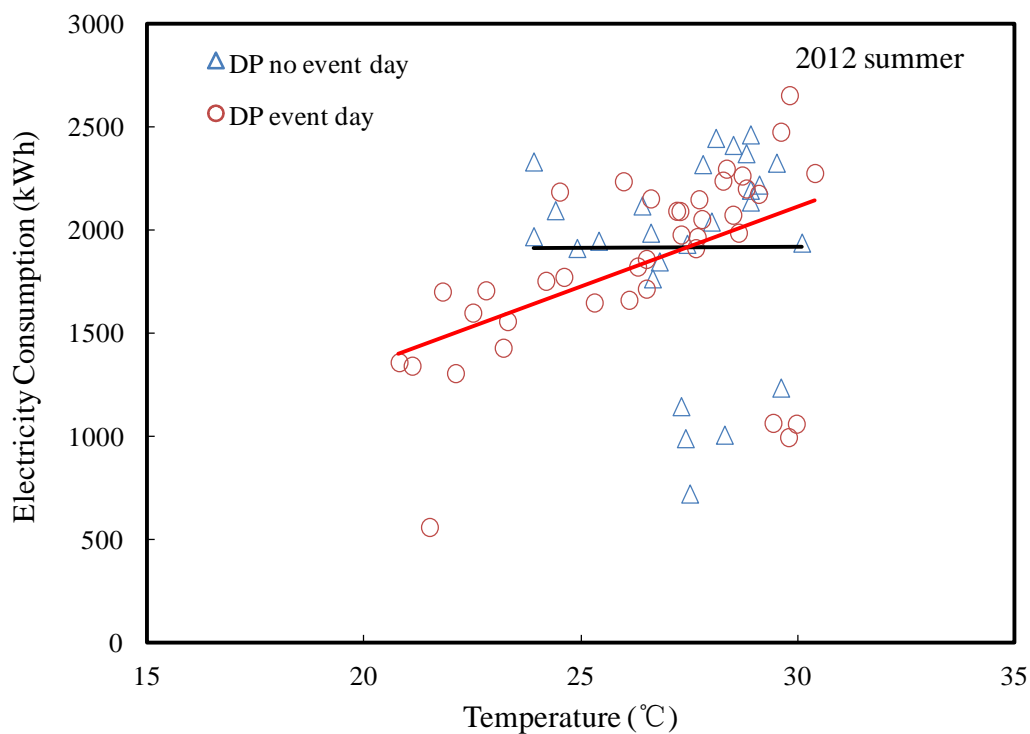

Figure 4-19 Correlations between electricity consumption and temperature  
in 2012 summer of Group D

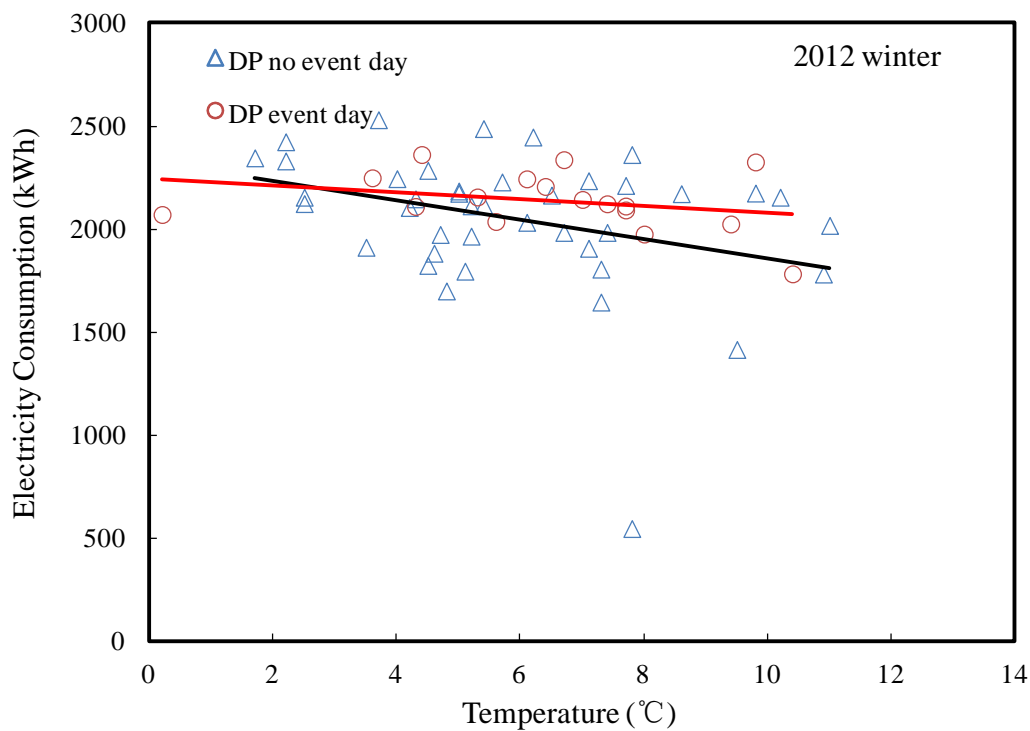

Figure 4-20 Correlations between electricity consumption and temperature  
in 2012 winter of Group D

### 4.3.5 Energy Consumption in Medical & Social Welfare

◇ Group E:

Special run mode decide the large amounts of energy consumption in medical & social welfare buildings. In such kind of building, various people use them and hospitals are open 24 hours a day. Furthermore, thousands of employees, patients, and visitors occupy the buildings daily, all the items referred here also have contributed to the large amounts of energy consumption in hospital. The heating and cooling load in hospital is sophisticated which result in that the air conditioning (HVAC) systems of it consumes more energy, as well. In addition, during the weekday, many energy intensive activities occur in medical & social welfare buildings: laundry, medical and lab equipment use, sterilization, computer and server use, food service, and refrigeration, all of these will aggravate the energy consumption of the building. Consequently, energy consumption in hospital buildings exhibit several characteristics in energy use including: (1) air-conditioning and hot water system always working and operate 24 hours a day year round. What's more, back-up machines are required due to the impatient, (2) multi-function services required such as surgery, diagnostic, healing, monitoring, food preparation and laundry, (3) some medical treatment equipment consumes huge electricity such as MRT, X ray etc. and (4) weather, operation mode and user's style affect the cost and consumption of hospital greatly.

Based on the contents referred above, energy efficiency of hospital becomes a necessity that cannot be over emphasized for long-term management. Efficient energy usage at all stages of the energy chain from production to final consumption is meaningful for the reduction of GHG and therefore the mitigation of climate change. One of the characteristics of countries' development is the high demand for health care and medical services in target countries. At present, the floor area

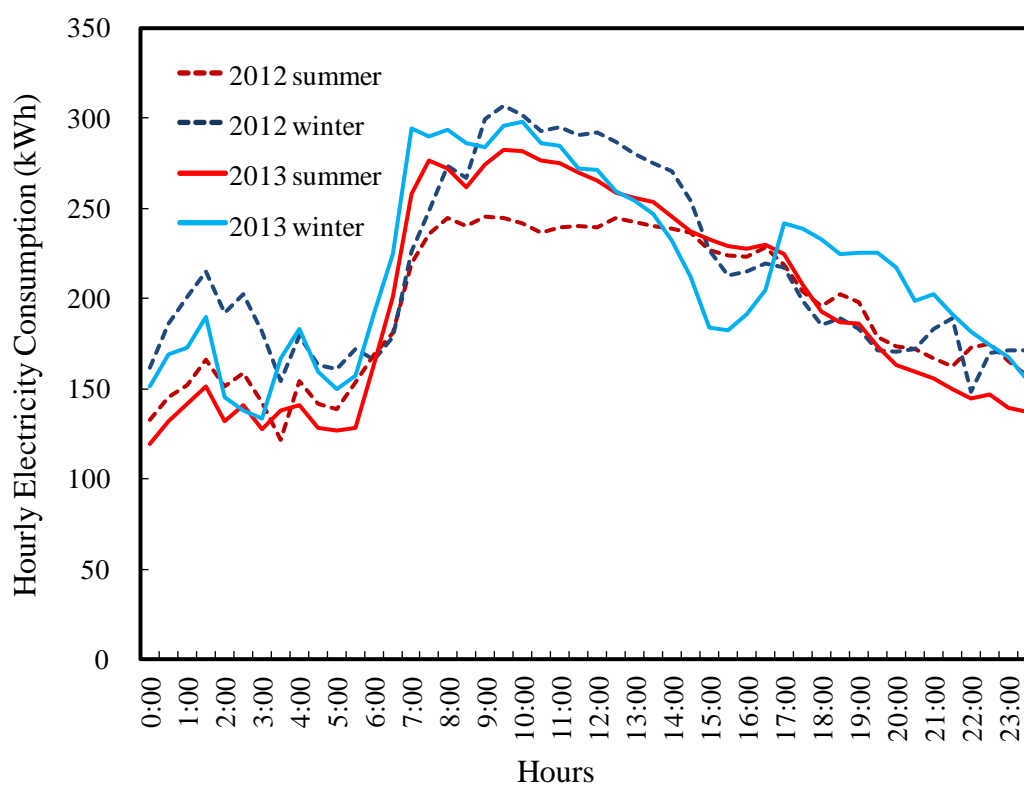

Figure 4-21 Hourly electricity consumption of group E

## CHAPTER FOUR: EXPLORATORY ANALYSIS OF KITAKYUSHU OFFICES RESPONSE TO DYNAMIC ELECTRICITY PRICING

of hospitals and clinics in most of countries is increased ever since. Therefore, it is essential to us to investigate the energy consumption situation of hospital. Figure 4-21 shows the hourly electricity consumption of group E. In this section, we just select one hospital as the reference to do the related analysis. As for hospital, the daily electricity load characteristics are tightly related to its working time and patients' hospitalizing time. We can clearly see from figure 4-21 that about 5:00, the electricity load reached at a small morning peak caused by patient rounds. After that, it starts to climb until reached at maximum load from 6:00 to 10:00, this is mainly because that many people prefer visiting hospital in morning which result in the opening of medical equipment. In the period from 10:00 to 17:00, electricity load remains high because of the hospitalizing time. After 17:00, the load has fallen slightly. At night time, the load curve is also not a straight line, owing to the emergency treatment and some medical activities of inpatient.

Like offices of group C and group D, we are also not draw the monthly electricity consumption figure in this part as same as Group A and Group B. Because of that we loss the electricity consumption data which need to select in 2010 and 2011.

In response to rising costs of health services and competitive environment, health care organizations must provide high quality services at lowest possible costs. Given this into consideration, it is essential to analysis the DP effect in such a rigorous background. Linear regression analysis of the electricity consumption and the corresponding outdoor temperature was conducted for Group E. Figure 4-22 and figure 4-23 presents the relationship between electricity consumption and temperature in 2012 for group E.

From figure 4-22, as anticipated, there was a significant phenomenon that the higher the temperature was, the higher the electricity consumption. The most possible reason is that the high temperature will leads to the high cooling load of hospital in summer. The appropriate temperature is beneficial to the patient's recovery. In winter, owing to the more energy resources will be needed for heating purposes, the energy consumption of hospital is still high, extremely in low temperature.

As for the DP effect evaluation, it is obvious that DP was appropriately performed in the reduction of electricity load in summer day and winter day (the red line represents the trend of electricity consumption in DP event day; the black line represents the trend of electricity consumption in DP no event day). Although it is difficult for hospital to adjust their electricity consumption activities to response to DP (for example, operation time is decide by the physical conditions of patients), it is still has the electricity consumption reduction effect mainly because of that there is an enforced response activity which turning off the lights partly in DP time for the hospital which we selected.

CHAPTER FOUR: EXPLORATORY ANALYSIS OF KITAKYUSHU OFFICES  
RESPONSE TO DYNAMIC ELECTRICITY PRICING

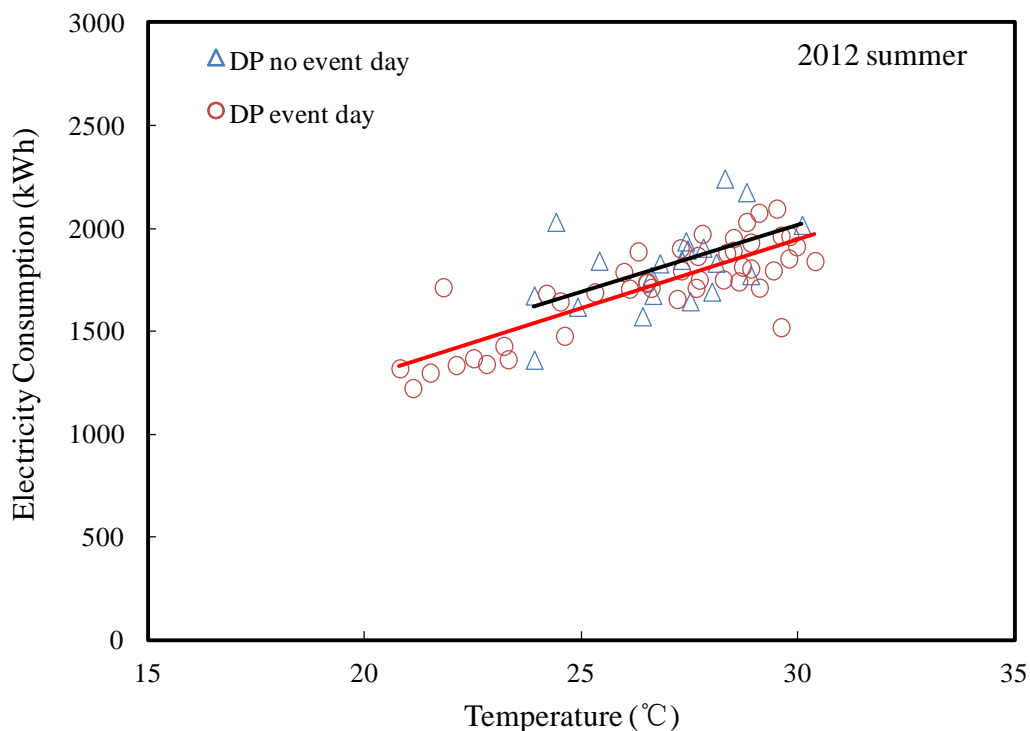

Figure 4-22 Correlations between electricity consumption and temperature  
in 2012 summer of Group E

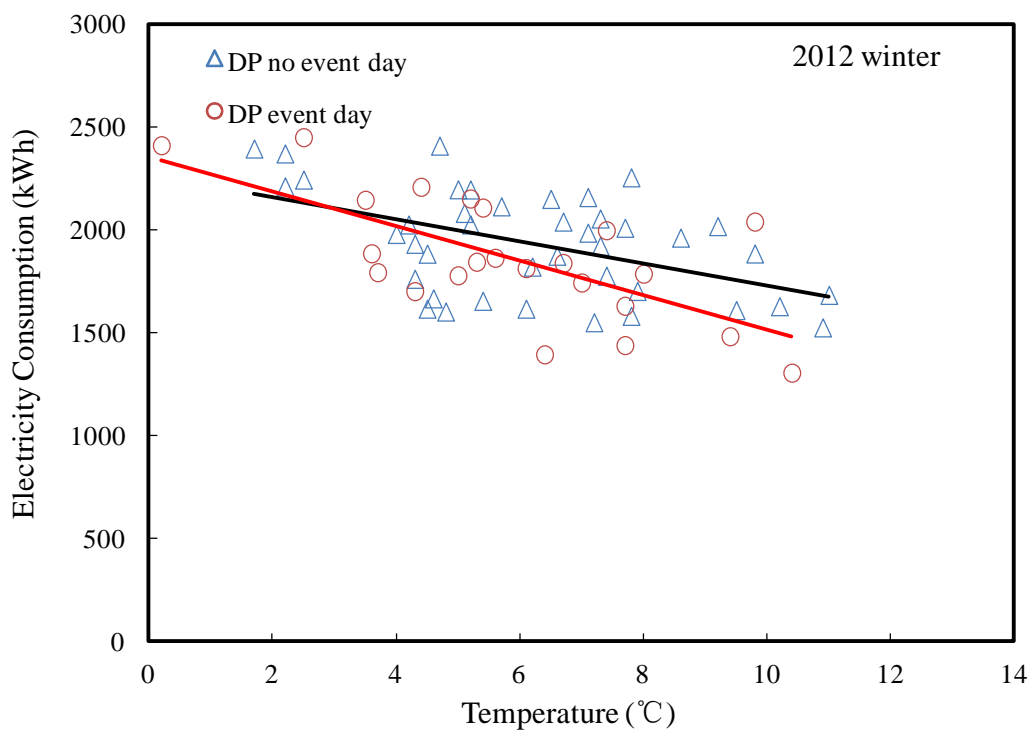

Figure 4-23 Correlations between electricity consumption and temperature  
in 2012 winter of Group E

### 4.3.6 Energy Consumption in Education Support Facility

◇ Group F:

This group includes some museums and exhibition halls. The people in such kind of buildings are complex which results in that it is difficult to control electricity consumption of it. In addition, the space of museums and exhibition halls is usually high and huge. Therefore, the electricity consumption conducted by air conditioning in museums and exhibition halls is bigger than other normal types of building. Lighting also accounts for a very important proportion of electricity consumption in museums and exhibition halls. Whether the focus of exhibition is art or science, technology or history, the presentation needs to be appealing, interesting and varied. And that is where lighting plays an important role.

In this section, we excluded data on weekend days when exploring the electricity consumption of museums and exhibition halls. Figure 4-24 presents the electricity consumption situation of group F in 2012 and 2013. It is the same with other office group, the electricity consumption in 2013 is lower than that in 2012 due to the influence of temperature. The result illustrates the hourly power consumption in summer and winter. As shown in the figure, the electricity consumption is mainly occurred in the period from 8 am to 7 pm. During the daytime of one typical day, the electricity load has no obvious change and always maintains a stable tendency. It also can be seen that the electricity consumption in winter is far lower than that in summer. One possible reason is that some exhibition need museum keep a certain humidity to protect exhibit and make sure the good visual experience. And the humidity in summer is higher than that in winter, so the dehumidification was inevitable for museum in summer which results in the higher

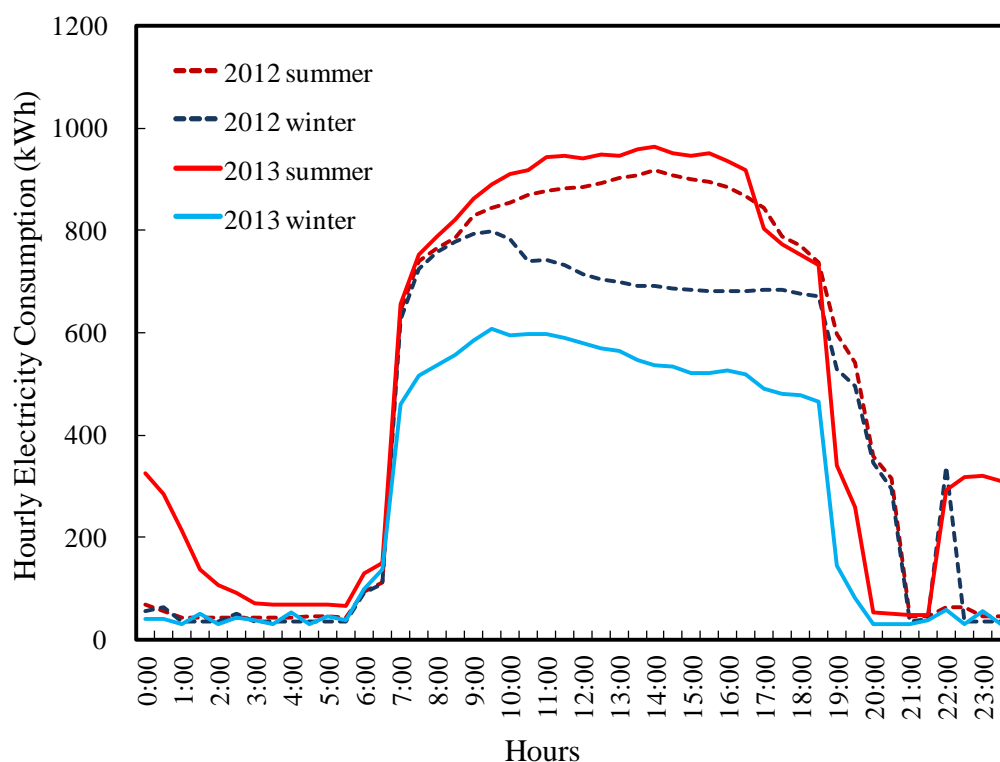

Figure 4-24 Hourly electricity consumption of group F

CHAPTER FOUR: EXPLORATORY ANALYSIS OF KITAKYUSHU OFFICES  
RESPONSE TO DYNAMIC ELECTRICITY PRICING

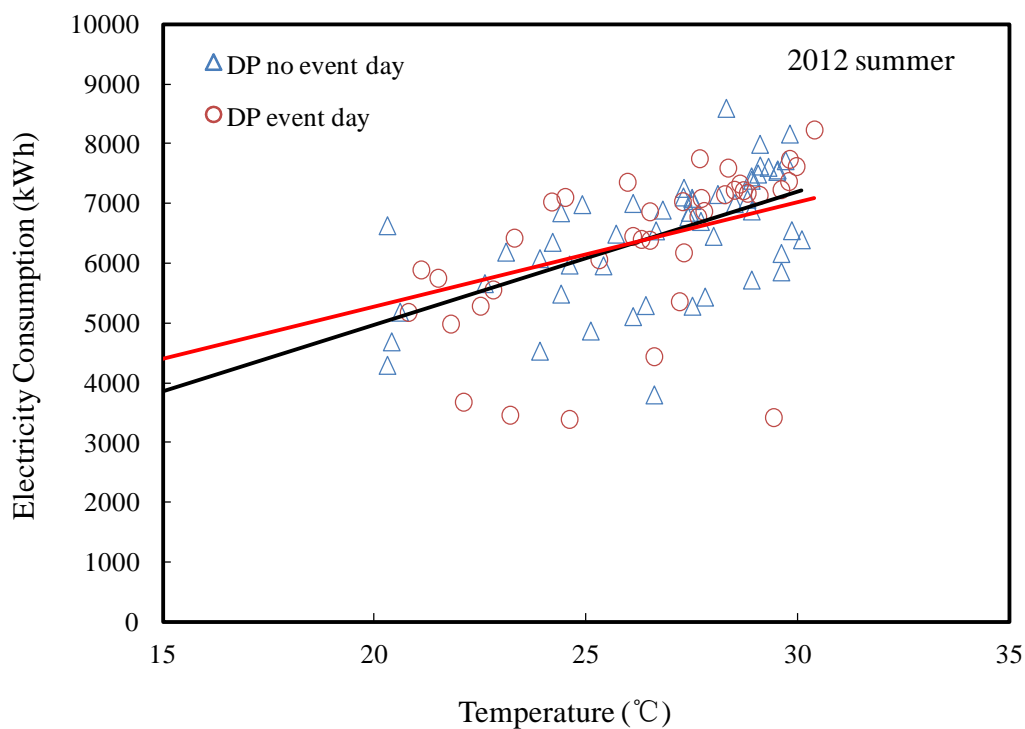

Figure 4-25 Correlations between electricity consumption and temperature  
in 2012 summer of Group F

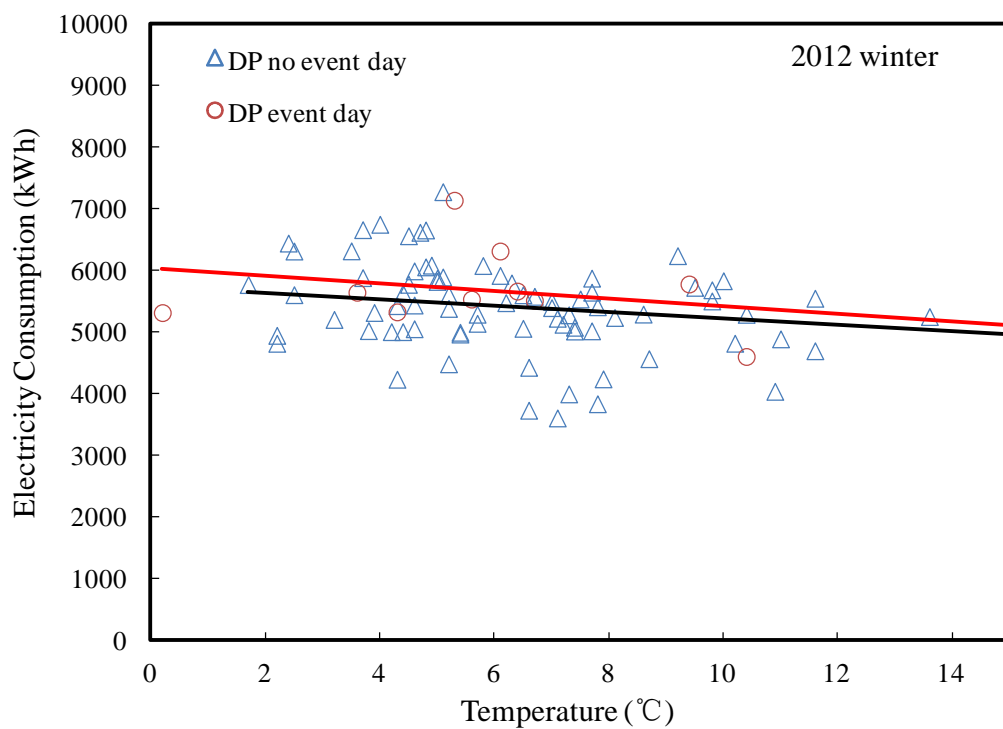

Figure 4-26 Correlations between electricity consumption and temperature  
in 2012 winter of Group F



## CHAPTER FOUR: EXPLORATORY ANALYSIS OF KITAKYUSHU OFFICES RESPONSE TO DYNAMIC ELECTRICITY PRICING

electricity consumption.

Like offices of group C, D and E, we are not draw the monthly electricity consumption figure in this part as same as Group A and Group B. Because of that we loss the electricity consumption data which need to select in 2010 and 2011.

Figure 4-25 and figure 4-26 presents the relationship between electricity consumption and temperature in 2012 for group F. Through the comparison between the trend of electricity consumption in DP event day (represented by red line) and electricity consumption in DP no event days (represented by black line), we can explore the influence of DP on electricity consumption reduction in museums and exhibition halls. From figure 4-25, it is clear that DP have electricity consumption reduction effect only when the temperature is higher than 28 centigrade in summer. In winter, DP has almost no effect in decreasing electricity consumption in museums and exhibition halls.

### 4.4 Evaluation of Offices Response to Dynamic Electricity Pricing

#### 4.4.1 Dynamic electricity pricing effect related to temperature

✧ Evaluation method

This part, we extracted the electricity consumption data from smart meter with the range from 13:00 to 17:00 which is the peak period of DP demonstration experiment, and make the association with the average temperature in that time period (peak time). Next, we divided the data calculated before by DP event day and DP no event day, compare its distributions through making a scatter chart. According to the figure, we can also get the correlation equations of DP event day and DP no event day. Then, using the correlation equations and substituted specific temperature values into the formulas, the results of electricity consumption reduction effect of DP by different temperature can be summarized. In this paper, we analyze the temperature 20 ° C and 30 ° C in the summer, and 1 ° C and 11 ° C in the winter to see the DP effect, respectively.

The final electricity consumption reduction effect (%) of DP can be calculated as the following formula shows.

$$\text{DP reduction effect} = \left(1 - \frac{A}{B}\right) \times 100$$

Where, A presents the total electricity consumption when assuming that DP was set every day; B presents that total electricity consumption when assuming that DP was always not set.

✧ Evaluation result

The result of DP electricity consumption reduction effect for various groups calculated as the method explained above was shown in following tables. Where, table 4-3 presents the DP reduction effect of various groups in 2012 summer and winter, table 4-4 presents the DP reduction effect of various groups in 2013 summer and winter. According to these two figures, it is obvious that DP is most effective in reducing the electricity consumption of Group A which represents complex commercial building. This conclusion also can be proved in the analysis of the relationship between electricity consumption and temperature which was shown above in this chapter. As for other kinds of offices (retail store, manufacturing industry, medical & social welfare and education support facility), according to table 4-3 and table 4-4, the DP has almost no effect when reducing its electricity consumption during the peak time. Actually, different from the

**CHAPTER FOUR: EXPLORATORY ANALYSIS OF KITAKYUSHU OFFICES  
RESPONSE TO DYNAMIC ELECTRICITY PRICING**

residential house, the DP effect of different office buildings depends on its characteristics and the nature of work. For example, hospital and some industries are difficult to change their energy consumption mode according to the set of DP owing to the operations and fixed production line.

Table 4-3 DP reduction effect of various groups in 2012 summer and winter

Group	2012 summer		2012 winter	
	20 °C	30 °C	11 °C	1 °C
Group A	5.37%	1.71%	11.74%	14.35%
Group B	-26.40%	-2.29%	-6.74%	-9.74%
Group C	5.05%	-6.03%	-12.10%	-14.35%
Group D	-0.01%	-4.02%	-8.40%	-7.11%
Group E	-4.31%	12.70%	6.18%	-17.98%
Group F	0.37%	-3.99%	-18.50%	-16.40%

Table 4-4 DP reduction effect of various groups in 2013 summer and winter

Group	2013 summer		2013 winter	
	20 °C	30 °C	11 °C	1 °C
Group A	11.56%	-0.03%	1.05%	2.63%
Group B	-	-5.10%	-1.91%	-1.08%
Group C	-	-4.22%	-7.81%	-2.10%
Group D	11.56%	-0.03%	0.92%	1.02%
Group E	-5.91%	10.44%	-17.78%	-8.19%
Group F	-	-6.07%	-0.91%	-15.50%

Taken group A as a reference to have further discussion of the effect of DP, it can draw the following conclusions. In summer, from the calculation according to approximate curve of electricity consumption and temperature, a DP reduction effect of 5.6% appears around 20°C of the air temperature. However, the effect decreased as the temperature rose, and it was found that the DP reduction effect was reduced to only 1.7% at 30°C. The reason that such a result appeared in Group A was that the reduction of electricity consumption is mainly because of the behaviors which carried out by BEMS and employees rather than the temperature. Based on the analysis of DP effect in summer in 2012 and 2013, we can also analyze the DP effect in winter in 2012 and 2013.

Table 4-5 shows the comprehensive evaluation of DP effect in different offices. The DP effect of offices as a whole, it is more complicated than that of residential house.

**CHAPTER FOUR: EXPLORATORY ANALYSIS OF KITAKYUSHU OFFICES  
RESPONSE TO DYNAMIC ELECTRICITY PRICING**

Table 4-5 Comprehensive evaluation of DP effect in different offices.

Group	Categories	Office Number	Characteristics
A	Complex commercial building	1	Realized the overall electricity consumption reduction by utilizing BEMS and other energy saving actions. However, it is difficult to share consciousness for all employees due to the large scale of the building.
B	Office	18	With BEMS, there is the office that has DP reduction effect. There is a difference in the degree of effectiveness of DP at each office. In addition, according to the energy saving evaluation, the overall energy consumption is decreasing, so the reduction effect of DP can be expected.
C	Retail store	9	Peak shift effect could not be confirmed in 7 retail stores. The overall energy saving effect was weak.
D	Manufacturing industry	5	The DP almost has no effect. The variation in the hourly electricity consumption was larger than that of other groups.
E	Medical & social welfare	3	There was virtually no difference between the electricity consumption of medical institutions in week days and weekends. This kind of office considered treatment business prior to any other things.
F	Education support facility	3	In the comparison of yearly electricity consumption of offices, energy saving effect was shown in each facility. However, no peak shift effect was observed

### **4.4.2 Dynamic electricity pricing effect related to standard baseline**

◇ Evaluation method

Due to the DP in offices has no comparison group, it is difficult to evaluate the electricity consumption reduction in DP event period. In order to solve this problem, we intend to calculate the baseline to do the comparison.

A baseline is an estimate of the electricity that would have been consumed by a demand resource in the absence of a demand response event. It is an important method to measure customer load reductions during DP event period. Two essential techniques for calculating baseline are day matching and regression analysis. In practical application, day matching was be widely used. The baseline which referred in the following discussion is all calculated by day matching method.

When we evaluate the DP reduction effect, two important elements is necessary: actual electricity use and the baseline. Here, actual electricity use is the amount of electricity the customer actually consumed during the DP event time; baseline it the amount of electricity the customer would have consumed without demand response. With these two key pieces, the mathematical difference between the baseline and actual electricity use can be explored.

Table 4-6 presents two important baseline types. One is using the historical interval meter data to calculate the baseline. Another is using statistical sampling data to calculate the baseline. Where, type 1 which using historical interval meter data is the most commonly used baseline method for performance measurement of demand resource in energy markets.

Table 4-6 Baseline types

Type	Content
Type 1	Calculated based on historical interval meter data for each demand resource
Type 2	Calculated based on statistical sampling for each demand resource

X of Y baseline is the most commonly baseline in type 1. X of Y baselines are a performance evaluation methodology based on historical interval meter data for a demand resource. They use data for the Y most recent days preceding a DR event. A high X of Y baseline uses meter data from a specified X number of days with the highest load within the set of Y days. The specified Y value in includes a specified number of days prior to a DR event, often between 5 and 10. This one element of the set used to construct a customer baseline. The Y group of days may be narrowed down to a subset of X days for a better representation of the DR event day. For example, a high 4 of 5 baseline would evaluate the previous five days (excluding weekends, etc.) and select the four with the highest load. An average 10 of 10 would include the last 10 qualifying days. In this section, we select high 4 of 5 method to calculate the baseline which we need.

The detailed calculating method of high 4 of 5 baseline is illustrated as follows:

- (1) Calculate the average value of target data (every 30 minutes) under the following conditions.
  - ① Within the last 5 days (excluding the DR implementation date), select 4 days (High 4 of 5) with high average electricity consumption during DR event period
  - ② The following days are excluded from the last five days
    - a).Saturday, Sunday, and a public holiday ·b). Past DR event date
- (2) As for 6 frames in 30 minutes from 4 hours to 1 hour before DR event time, calculate the average value of the following formula:

The electricity demand for DP event day - the value calculated by step (1) = (2)

## CHAPTER FOUR: EXPLORATORY ANALYSIS OF KITAKYUSHU OFFICES RESPONSE TO DYNAMIC ELECTRICITY PRICING

(3) the value of (2) to the value of (1) on the DR event time as the baseline

When finished the calculation of standard baseline, it still need to test the baseline. The test flow was shown in figure 4-27.

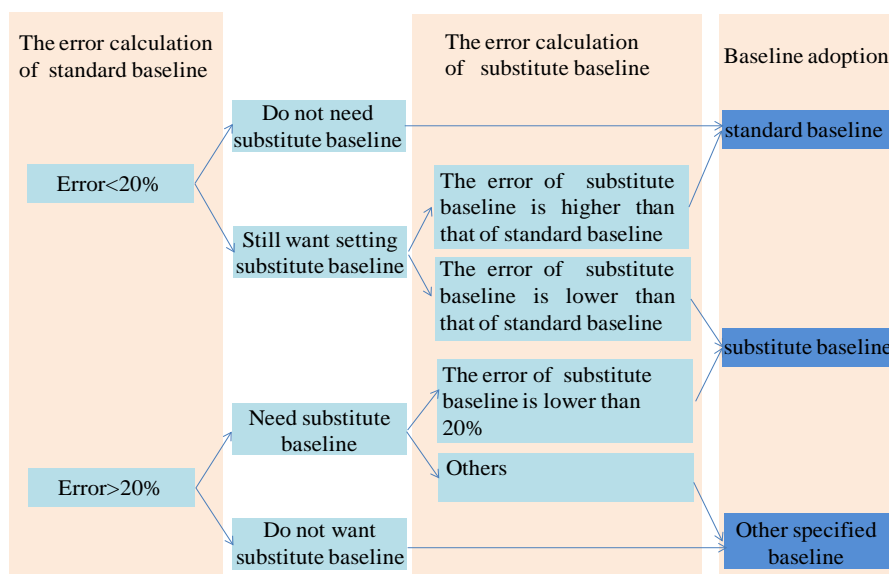

Figure 4-27 Baseline test flow

### ✧ Evaluation result

Based on calculation method which explained above, we can explore the peak load reduction effect of DP through the comparison between the baseline and actual electricity use. In the process of calculation, due to that Saturday, Sunday, public holiday and the past DR event date need to be excluded during using High 4 of 5 method. Therefore, we just select 4 typical days (2012/09/03, 2012/09/05, 2012/09/11, 2012/09/18) to discuss the peak load reduction effect of DP according to the real DP event date. In this section, we mainly take complex commercial building, retail store, hospital and education building as example to do the baseline calculation.

Figure 4-28, 4-29, 4-30, 4-31 show the electricity consumption saving by baseline comparison in four different kinds of buildings. Through compare the load curve of actual electricity use and baseline, it is obvious that the electricity consumption of baseline is almost higher than that of actual situation which proved that DP is effective in reducing electricity consumption in peak time period.

## CHAPTER FOUR: EXPLORATORY ANALYSIS OF KITAKYUSHU OFFICES RESPONSE TO DYNAMIC ELECTRICITY PRICING

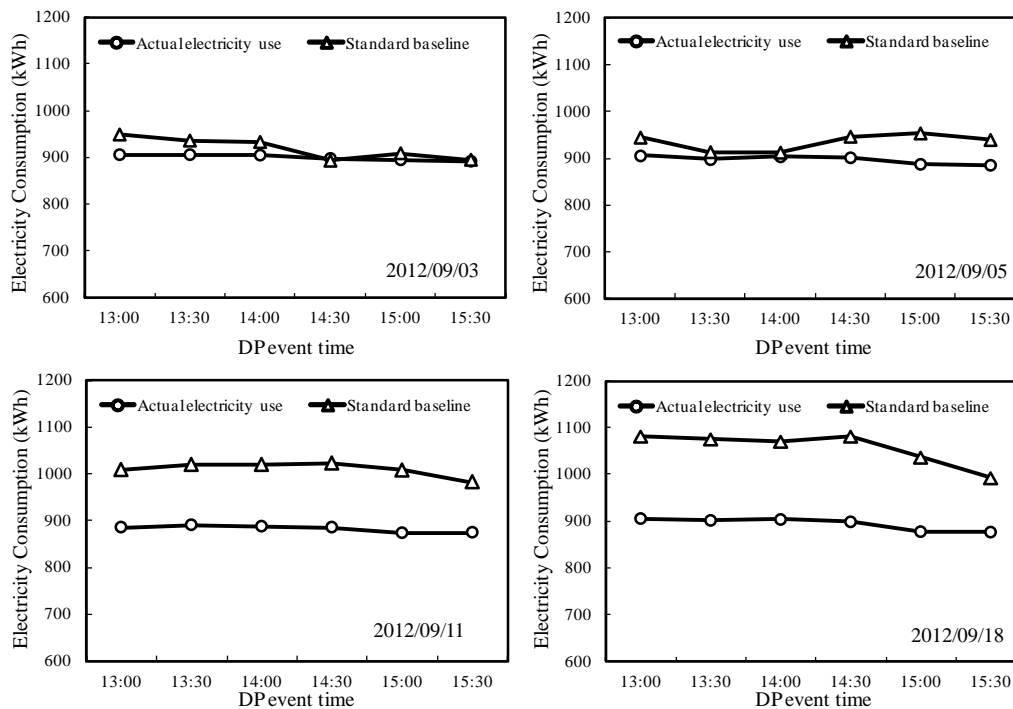

Figure 4-28 Electricity consumption saving by baseline comparison  
in complex commercial building

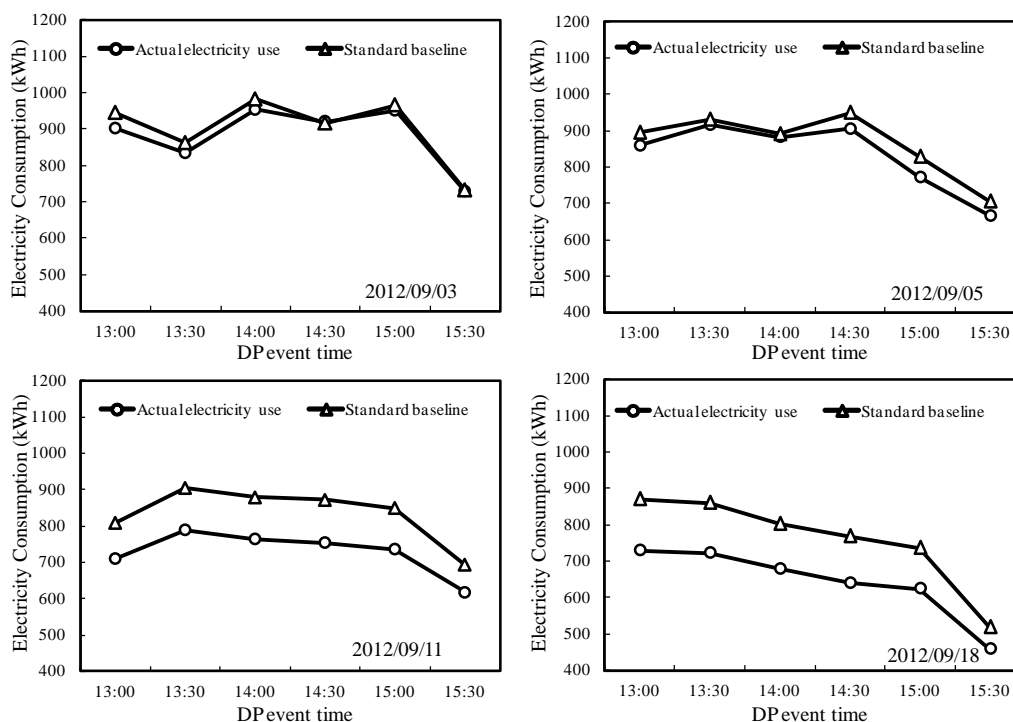

Figure 4-29 Electricity consumption saving by baseline comparison  
in retail store

CHAPTER FOUR: EXPLORATORY ANALYSIS OF KITAKYUSHU OFFICES  
 RESPONSE TO DYNAMIC ELECTRICITY PRICING

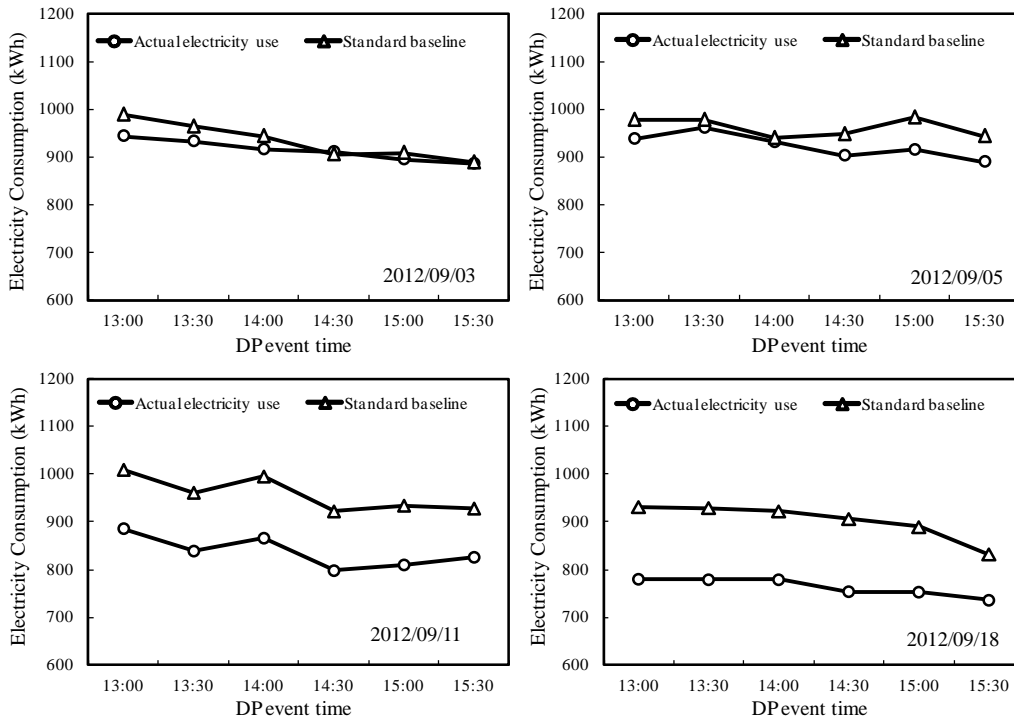

Figure 4-30 Electricity consumption saving by baseline comparison  
 in medical & social welfare

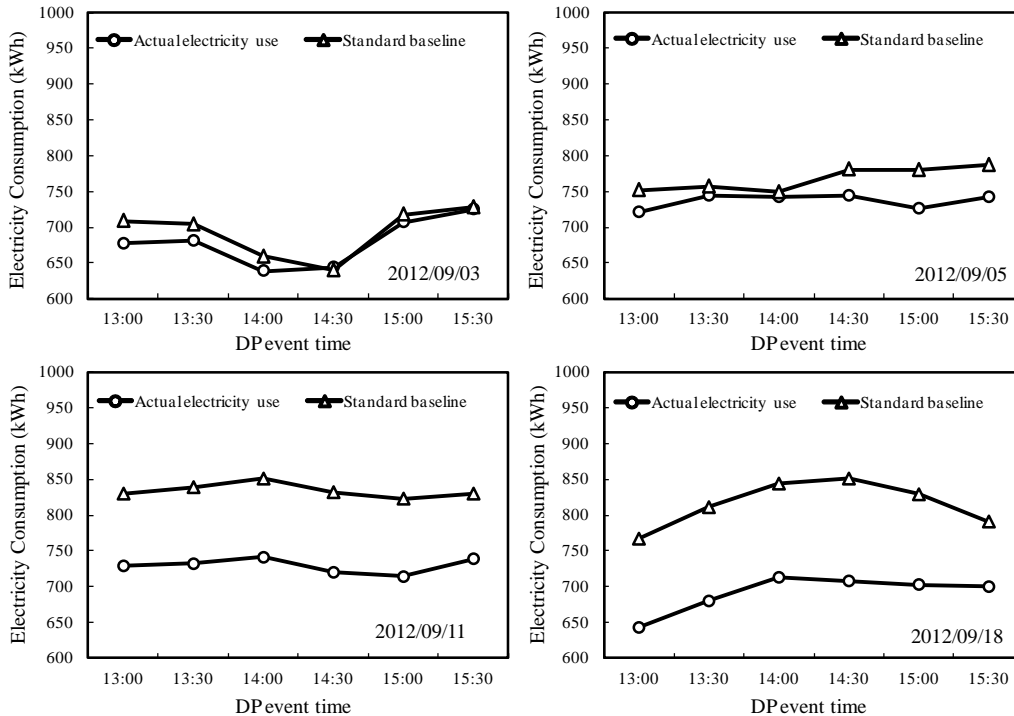

Figure 4-31 Electricity consumption saving by baseline comparison  
 in education support facility

**CHAPTER FOUR: EXPLORATORY ANALYSIS OF KITAKYUSHU OFFICES  
RESPONSE TO DYNAMIC ELECTRICITY PRICING**

**4.4.3 Dynamic electricity pricing effect related to people’s consciousness**

In this part, we only select group A which is complex commercial building to do the analysis. Compared to the DP utilization in residents, the DP peak reduction effect of commercial building is far lower than that of residential house. Therefore, we try to investigate the energy saving behavior and energy saving consciousness of employees which worked in each store.

Figure 4-32 is the result of questionnaire which related to dynamic pricing made by Kitakyushu City. There are 23 stores answered that business have the priority when compared to response to DP, accounts for almost 50% of total stores. And 12 stores thought that only rely on the energy saving actions of employees have the limitation when response to DP. There are still various other reasons that each store can’t response to DP well.

According to figure 4-33, we can also know that most of stores intended to take actions to response to DP, bur finally not able to do it. All of these presents that although DP is an effective way to saving energy, there are no sufficient factors to stimulate participants to take real actions to response to DP. Consequently, giving consideration to both energy saving and economic benefit is an essential way to heighten the effective utilization of DP in commercial building. Figure 4-34 shows us that with the introduction of DP, 73% of employees increased their consciousness of energy saving.

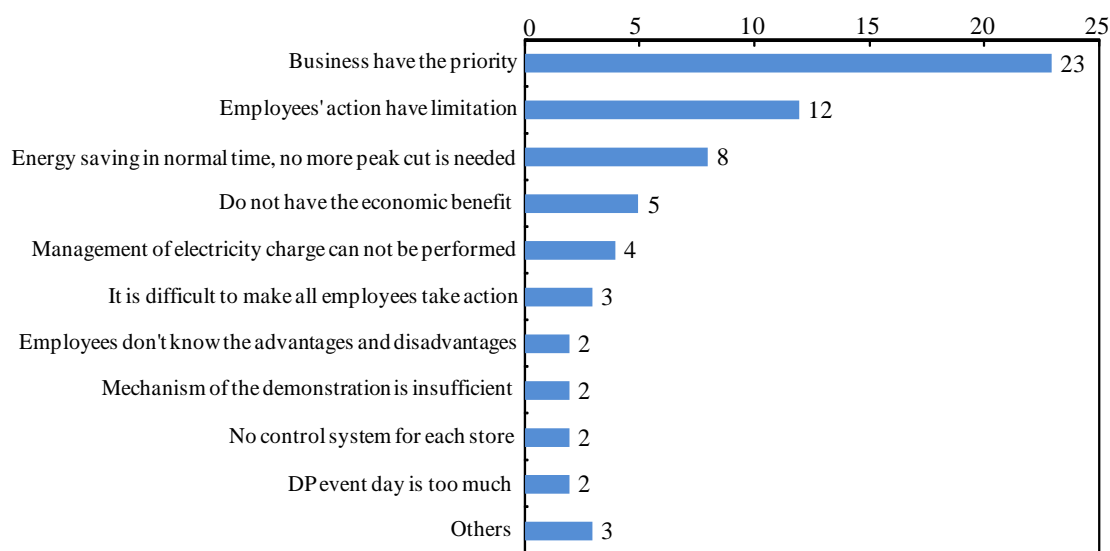

Figure 4-32 Results of questionnaire which related to dynamic pricing



CHAPTER FOUR: EXPLORATORY ANALYSIS OF KITAKYUSHU OFFICES  
 RESPONSE TO DYNAMIC ELECTRICITY PRICING

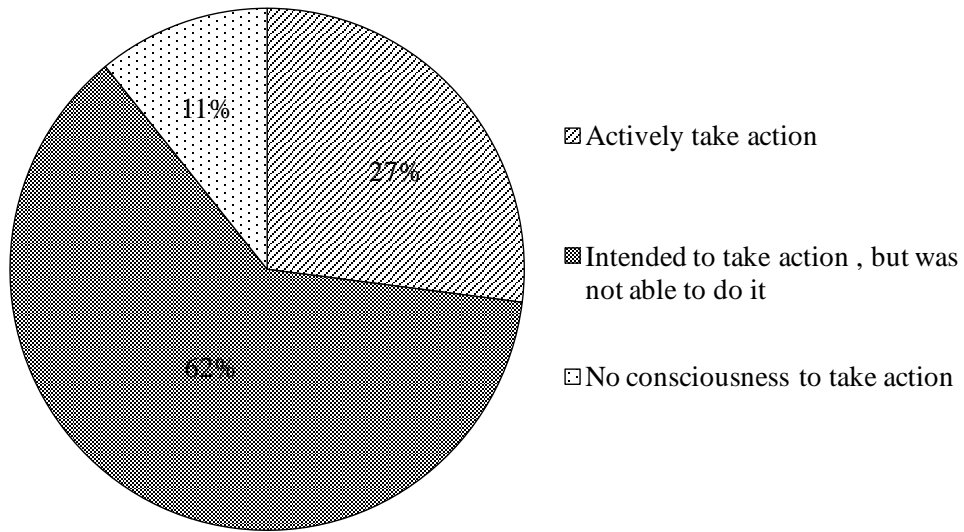

Figure 4-33 Did you actively take action in order to respond to dynamic pricing?

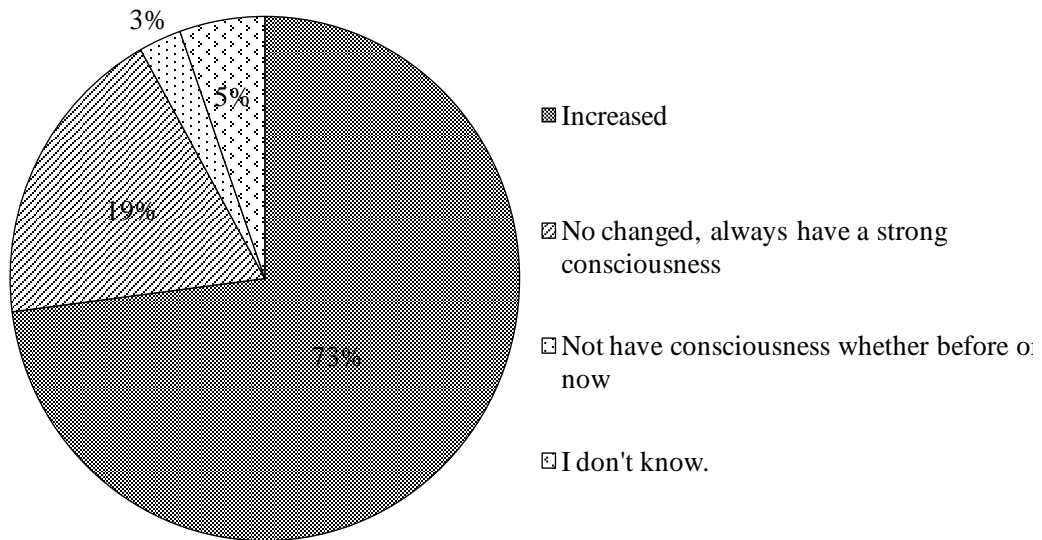

Figure 4-34 Did your consciousness of energy saving have increased?

## CHAPTER FOUR: EXPLORATORY ANALYSIS OF KITAKYUSHU OFFICES RESPONSE TO DYNAMIC ELECTRICITY PRICING

### 4.5 Summary

This chapter introduces the database of offices which have taken part in the Kitakyushu smart community project, firstly. Unlike households, the size and form of each office is totally different. Therefore, all the participating targets were divided into seven categories according to the characteristic of each office. Meanwhile, we investigate the electricity pricing system of offices in the project. As for offices, two kinds of pricing methods were provided to the consumers, one aims to restrain the electricity consumption, another one is to encourage the electricity consumption. There are 13 specific pricing levels when DP was introduced into the offices, actually.

Then, this chapter investigates the energy consumption of target office building. Using hourly load data collected from smart meter, hourly electricity consumption, monthly electricity consumption and relation between the electricity consumption and temperature were explored. Draw the conclusion that the hourly electricity consumption is tightly related to the working mode of each office. In addition, as for all kinds of offices, the electricity usage of 2012 and 2013 is lower than that of 2010 and 2011 which due to the energy saving actions after the Great East Japan Earthquake. The monthly electricity consumption of each office also reveals that July and August have the largest electricity consumption throughout the year. Furthermore, the electricity consumption of office is strongly influenced by the temperature. There was a significant phenomenon that the higher the temperature was, the higher the electricity consumption.

Finally, this chapter estimates the effect of dynamic pricing system on the energy saving of office, concludes that the load reduction for participants during the DP time block is occurred. In this section, we discussed the dynamic electricity pricing effect related to temperature, standard baseline and the consciousness of employees. It was found that the gap between the electricity consumption of DP no event day and DP event day was not absolutely increased with the increase of temperature. It affected by many other items. Due to the loss of control group and experiment samples, baseline was also used to analyze the effect of DP. The results show the well peak load reduction effect of DP through the comparison of the load curve of actual electricity use and baseline. The consciousness of employees is an uncontrollable element which affects the import effect of DP. According to the questionnaire which made by Kitakyushu City, there are more than half the offices approve that the business have the priority when compared to response to DP. The employees thought of that their energy saving actions have limitation and such kind of actions should be carried out in normal days, no more peak cut is needed. However, it is also proved that with the introduction of DP, 73% of employees increased their consciousness of energy saving.

## CHAPTER FOUR: EXPLORATORY ANALYSIS OF KITAKYUSHU OFFICES RESPONSE TO DYNAMIC ELECTRICITY PRICING

### REERENCE

- [1] Joseph C. Lam, Danny H.W. Li. "Electricity consumption characteristics in shopping malls in subtropical climates". *Energy Conversion and Management*. Vol. 44, Issue 9, June 2003, Pages 1391–1398.
- [2] A. Menezes, A. Cripps, D. Bouchlaghem, R. Buswell. "Analysis of electricity consumption for lighting and small power in office buildings". *CIBSE Technical Symposium*, 6th–7th September, DeMontfort University, Leicester, UK (2011).
- [3] Carbon Trust. *Office Equipment – Introducing Energy Saving Opportunities for Business*. CTV005(2006).
- [4] J.C Lam. "Climatic and economic influences on residential electricity consumption". *Energies. Convers. Manage.*, 39 (7) (1998), pp. 623–629
- [5] J.C Lam. "Climatic influences on the energy performance of air conditioned buildings". *Energies. Convers. Manage.*, 40 (1) (1999), pp. 39–49.
- [6] S. A. Tasou, Y. Ge and A. Hadaway. "Energy Consumption and Conservation in Food Retailing". Brunel University.
- [7] Yusuke Suzuki, Yohei Yamaguchi, Kaori Shiraishi, Daisuke Narumi, "Yoshiyuki Shimoda. Analysis and Modeling of Energy Demand of Retail Stores". *Proceedings of Building Simulation 2011:12th Conference of International Building Performance Simulation Association*, Sydney, 14-16 November.
- [8] T. Rackow, T. Javied, T. Donhauser, C. Martin, P. Schuderer und J. Franke, *Green Cockpit: Transparency on Energy Consumption in Manufacturing Companies.*, in *CIRP 12th Global Conference on Sustainable Manufacturing*. , Johor Bahru, Malaysia, 2014.
- [9] Tallal Javied, Tobias Rackow, Roland Stankalla, Christian Sterk, Jörg Franke. *A Study on Electric Energy Consumption of Manufacturing Companies in the German Industry with the Focus on Electric Drives*. *Procedia CIRP*. Vol.41, 2016, Pages 318-322.
- [10] Shabnam Mahmoudzadeh Vaziri, Babak Rezaee, Masoud Amel Monirian. *Bi-Objective Integer Programming of Hospitals Under Dynamic Electricity Price*. *Proceedings of the Tenth International Conference on Management Science and Engineering Management*.
- [11] S.C. Hu, J.D. Chen and Y.K. Chuah. *Energy Cost And Consumption In A Large Acute Hospital*. *International Journal on Architectural Science*, Volume 5, Number 1, p.11-19, 2004.
- [12] Mark S. Martinez, Ryn Hamilton. *Role of Demand Response Baselines In Estimating Participant Impacts*. *Energy Utility & Environment Conference*, January 30, 2013.



## **CHAPTER FIVE: EVALUATION METHODS FOR ELECTRICITY DYNAMIC PRICING SYSTEM AND ENERGY SAVING TECHNOLOGIES**

### 5.1 Introduction

### 5.2 Overview of the evaluation method

5.2.1 Overview of the evaluation method for electricity dynamic pricing system

5.2.2 Overview of the evaluation method for energy saving technologies

### 5.3 Methodology for evaluation

5.3.1 Description of the energy system

5.3.2 Methodology for evaluating electricity dynamic pricing system

5.3.3 Methodology for evaluating energy saving technologies

### 5.4 Assessment criteria

5.4.1 Assessment for economy performance

5.4.2 Assessment for energy performance

5.4.3 Assessment for environmental performance

### 5.5 Summary



## 5.1 Introduction

Electricity dynamic pricing is a new kind of pricing system which can realize the two-way communication in the power market. Customers could change their electricity consumption behaviors according to the different price signals or incentive mechanisms. Essentially, electricity dynamic pricing allows the cost of electricity to reflect how expensive the power actually is to produce, which varies depending on the time of day because of changes in demand across the grid system. It is the most significant evolutionary developments in pricing systems in recent years.

The development of electricity dynamic pricing has attracted considerable interest from fields as diverse as economics, sociology and electrical engineering. Research on its development and application has been carried out worldwide for more than ten years, and there are already many practical cases and rich experiences in this field. Due to each country has its own electricity market modes and basic energy situation which results in the achievements of their utilization of electricity dynamic pricing are different. Therefore, the objective evaluation of such kind of pricing system is extremely crucial issue before the widely promotion of it. Furthermore, based on the previous studies which shown in this paper, electricity dynamic pricing was anticipated to cause economy losses when there were no demand response. In order to solve this problem, energy saving technology was assumed to introduce into the DP system. Corresponding to this situation, the evaluation of the introduction of energy saving technology is also need to do the further discussion.

This chapter attempts to develop the evaluation system for the utilization of electricity dynamic pricing and energy saving technology. Its findings will provide an instrument for government and power companies to process the following development of electricity dynamic pricing.

## 5.2 Overview of the evaluation method

As for the evaluation method of electricity dynamic pricing and energy saving technologies, there are various directions and contents corresponding to the different objectives. This section presents an overview of DP evaluation method and energy saving method according to the related references.

### 5.2.1 Overview of the evaluation method for electricity dynamic pricing system

The evaluation of electricity dynamic pricing based on demand response programs is an emerging field of study that is not as mature as the evaluation of traditional energy efficiency programs. Based on previous studies which aimed at evaluating DP programs, ultimately the measurement of dynamic pricing focuses on estimating how energy use patterns for a set period of time are different from how they would have been in the absence of the demand response program owing to that dynamic pricing often uses enabling technologies. Actually, there are still other essential items which influence the evaluation of dynamic pricing. Figure 5-1 shows the main evaluation directions of electricity dynamic pricing. There are three directions when evaluating DP systems, evaluate DP from participants, evaluate DP from non-participants and evaluate DP from market side. Figure 5-2 presents the evaluation method of electricity dynamic pricing. In this paper, we only consider the evaluation of load reduction effect of DP.

The customers of DP programs currently under implement usually have been evaluated using criteria that include participant satisfaction, energy use change and bill impacts. When one DP system was introduced, whether participant consider it easy to participate or not is very important to the successfully deployment of DP. Furthermore, the energy use change of customers is also an essential subset of DP evaluation from participant side. Participant savings are important for the individual participant and contribute to the popularity of DP programs. According to previous study, the dynamic rates have the load reduction effect for almost every DP program. Figure 5-3 summarizes the findings from most of these studies in terms of estimated percentage peak load

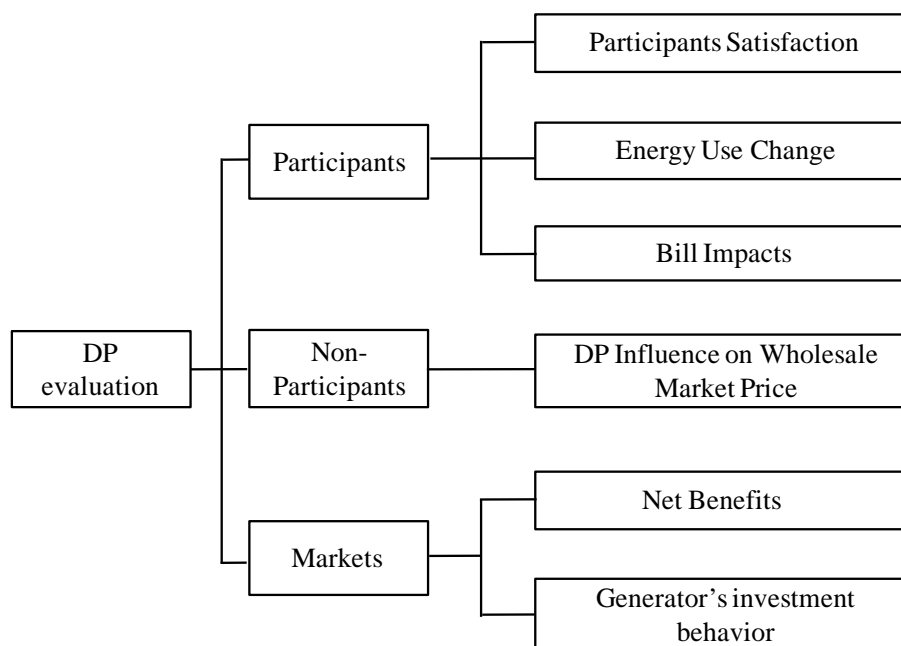
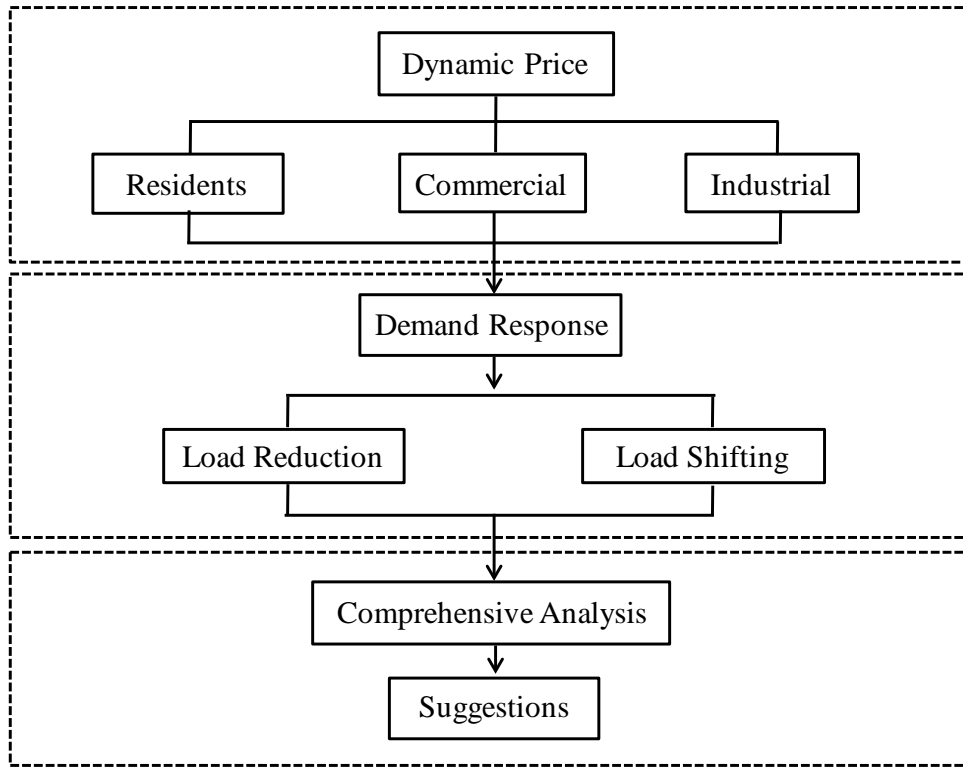

Figure 5-1 Evaluation directions of electricity dynamic pricing





Figure

5-2 Evaluation method of electricity dynamic pricing

CHAPTER FIVE: EVALUATION METHODS FOR ELECTRICITY DYNAMIC PRICING SYSTEM AND ENERGY SAVING TECHNOLOGIES

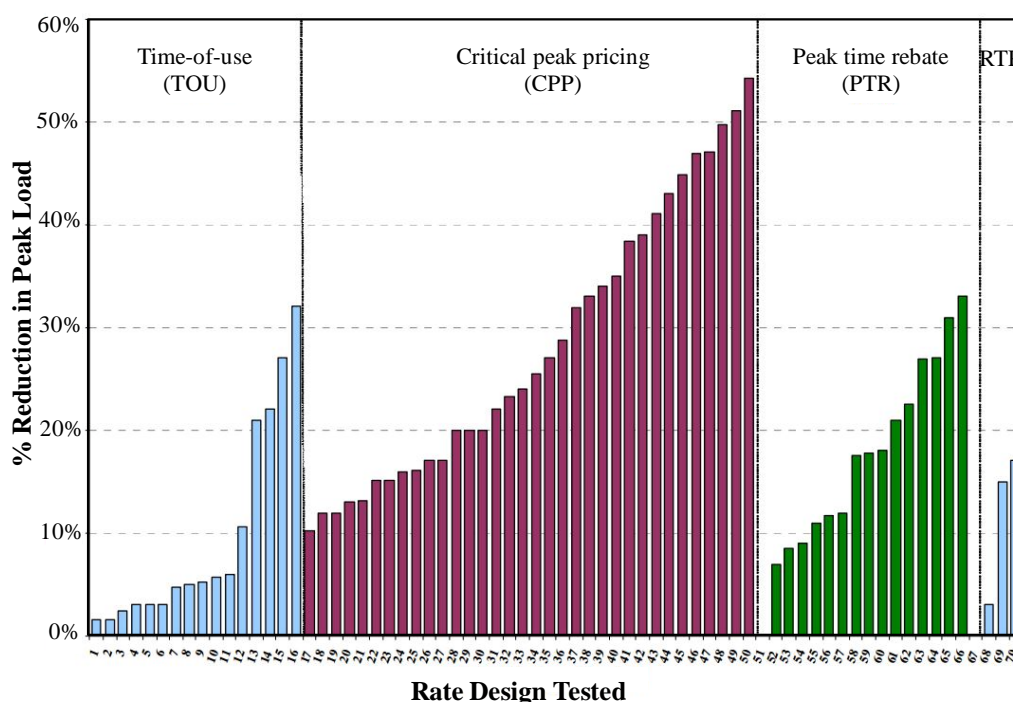

Figure 5-3 Comparison of Peak Load Reductions across Dynamic Pricing Programs

reductions. Where, the numbers of the horizontal axis represent discrete DP programs and rate design pilots and explain how these seventy different pilots have consistently found similar results. This part of evaluation can be done in a number of ways, such as establishing a baseline load curve of a non-event day for use as a comparison group to the hourly load profile of the event day, or estimate the elasticity of demand to price. While economists calculate a variety of types of elasticity of demand, the basic concept is to measure how, as the price of electricity changes, the predicted use of energy changes as well. Load shifting is another feasible way to evaluate DP from the energy use change for participant. Participant bill impact have also considered in the evaluation of DP. Generally, bill saving have largely come from the change in energy usage, not the structural changes of the underlying rate.

In addition to the DP evaluation of participant, non-participant benefits is also worth us to do the discussion. Although DP program can effectively affect the load curve of consumers which would reduce the electricity consumption of customers, the influence of DP on wholesale market price will also brings economic effect to non-participant. As for the long term evaluation of DP program, the influence of DP on electricity market is also necessary. Many researches claim that short-term reductions in wholesale price spikes will automatically result in lower future contract prices which ignore the dynamic effects of price expectations on generators' investment behavior, which in turn affects future market prices. Reducing peak demand can mean postponing or avoiding development of new generating capacity and transmission or distribution investments. It will dramatically affect the net benefits.

### 5.2.2 Overview of the evaluation method for energy saving technologies

In recent years, there has been increased public awareness of the need to develop low carbon society and sustainable energy systems. This is mainly owing to the worldwide energy price hike in 2008. What's more, many people around the world are becoming interested in participating in "green" living. While in making such a lifestyle choice, individuals commit to reducing their impact on the environment. Therefore, the utilization of energy saving technologies becomes more common among the current daily life, and it is necessary for us to provide an effective evaluation method for energy saving technologies. This section will give a overview about the evaluation method for energy saving technologies, subsequently.

Generally, if energy saving technology can maintain operation at high operation rate, it will contribute to energy conservation, environmental conservation and improve the system reliability. However, its effectiveness is not unconditionally achieved. The quantitative evaluation of the technology is required along with cautious planning and design in considering its introduction. It is common that evaluating energy saving technologies from following aspects:

- (1) Energy saving performance
- (2) Economy performance
- (3) Environmental performance
- (4) Others (such as electricity load leveling effect, etc.)

◇ Energy saving performance

Energy saving performance is an index which evaluating the whole energy consumption of the building. It is usually calculated by comparing the annual energy consumption of the alternative energy system (AES) and conventional energy system (CES). Due to energy saving performance is the comparison of the primary energy consumption between the two systems, the utility grid electricity need to be converted to primary energy. In this paper, all coefficients which be used in calculation is based on the Japanese standard owing to that the related data is all selected from Japan. In this case, in addition to the Okinawa electricity company, other 9 electricity companies have the power generation efficiency of 35.1% (corresponding to high calorific value standard) when considering the transmission loss, Moreover, if the backward flow of surplus electric power to the utility grid occurs, assume the input amount of primary energy reduced by this parts, and convert it into primary energy consumption with the same coefficient. Table 5-1 shows the conversion coefficient of heating value in the Kitakyushu area.

Table5-1 Conversion coefficient of heating value in the Kitakyushu area

Energy sources	Coefficient of heating value
Electricity	9.97MJ/kWh
Gas	46.06MJ/m <sup>3</sup>

## CHAPTER FIVE: EVALUATION METHODS FOR ELECTRICITY DYNAMIC PRICING SYSTEM AND ENERGY SAVING TECHNOLOGIES

### ✧ Economy performance

Both economy evaluation and energy saving evaluation are relative evaluation which examined by comparison with the conventional system. Although economic performance is tightly related to energy saving performance, it is not mean that the high energy saving effect will absolutely results in the high economy performance. When we design a system with energy-saving technology, it is important to establish a more economical system from the perspective of social contribution while considering both energy conservation and environmental protection. Initial cost and running cost are two essential items when we talking about the economy performance of the target system and it will be presented in the following paragraph. In addition, some representative evaluation index which corresponding to economy will be also introduced.

An energy system's initial costs are those that are incurred during the design and construction process. They can include any of the following: planning, preliminary engineering, project design and equipment cost. Once the structure of the system is decided, the initial cost is almost unchanged. Generally, the initial cost of the system is roughly estimated by the system's capacity.

The running cost is the sum of fuel costs such as gas, oil; electricity cost of utility grid; income of selling extra electricity of the system; energy cost such as water supply and sewage charges, and maintenance cost, etc. As for the evaluation index of running cost, it can be concluded as follows.

#### ① Pay-back year

Pay-back year in energy system refers to the period of time required to recoup the funds expended in a system investment, or to reach the break-even point. It is usually be used to determine the acceptability of the investment proposal. The Pay-back year is obtained by dividing the increment of the initial cost when introducing AES by the annual operation merit (the reduction of the running cost) by a simple and qualitative comparison. It is the most frequently used index from the initial stage of designing an energy system, but it is not suitable for long-term quantitative economic indicators which corresponding to the working life of facilities and buildings already be recovered investment. Figure 5-4 illustrates the initial cost and running cost of alternative energy system and conventional energy system. The payback year can be calculated by the formula as shown in Eq. (5-1).

$$\begin{aligned}
 \text{Payback year} &= \frac{\text{Initial cost of DES} - \text{Initial cost of conventional system}}{\text{Running cost of conventional system} - \text{Running cost of DES}} \quad (5-1) \\
 &= \frac{\text{Increase of equipment cost}}{\text{Decrease of running cost}} \\
 &= \frac{A}{B}
 \end{aligned}$$

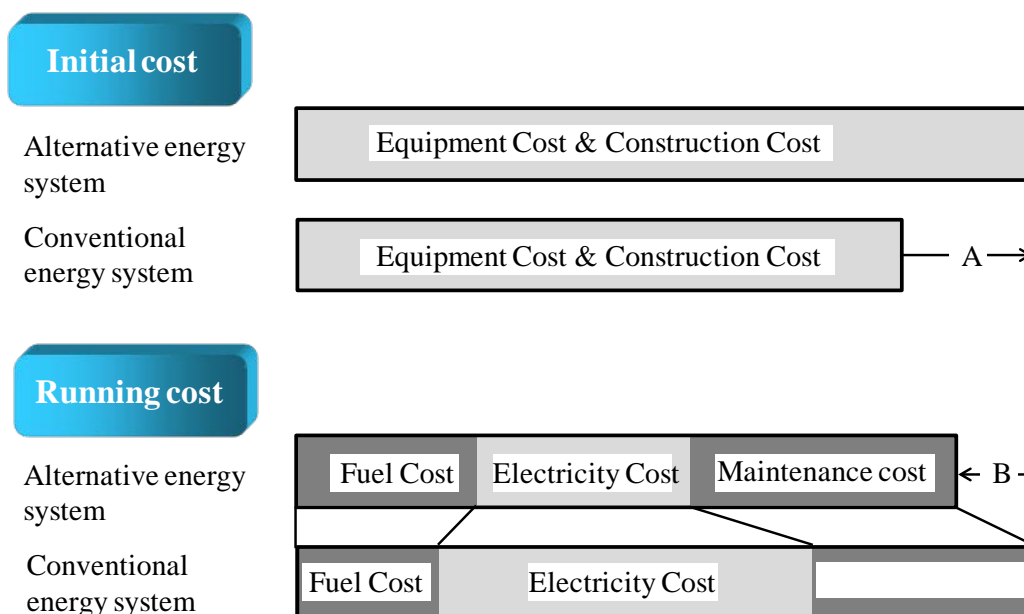

Figure 5-4 Initial cost and running cost of new energy system and conventional energy system

② Annual yearly cost

Annual yearly cost is the most convenient index that can evaluate the long-term economic performance of energy system which equipped with energy saving technologies. It shares the total initial cost into each year and compared it with the conventional system. In other words, it is obtained by adding the variable cost (running cost) to the fixed cost which has been converted into the amount per year. In the process of converting, the life time of the equipment and interest rate were both taken into consideration. The annual yearly cost can be calculated by the following formula.

If the calculated annual yearly cost of the new energy system is lower than that of conventional system, we can believe that the energy system with energy saving technology have the economy performance.

$$\text{Annual yearly cost} = \text{Running cost} + \text{Initial cost} \quad (5-2)$$

$$\text{Initial cost} = \text{Equipment cost} \times \text{fixed rate} \quad (5-3)$$

$$\text{Fixed rate} = (1 + Ar)^t \frac{i(1+i)^t}{(1+i)^t - 1} + \frac{A_r(1 - S/C)}{(1 - \sqrt[S/C]{}) \times t} \quad (5-4)$$

$C = \text{Equipment Cost}$        $S = \text{Residual price}$

$t = \text{Service life}$                $i = \text{Rate}$

$A = \text{Evaluation rate}$          $r, r' = \text{Tax rate}$

③ Life cycle cost (LCC)

From an economic standpoint, life cycle cost is the total cost of ownership of machinery and equipment, including its cost of acquisition, operation, maintenance, conversion, and/or decommission. LCC are summations of cost estimates from inception to disposal for both equipment and projects as determined by an analytical study and estimate of total costs

## CHAPTER FIVE: EVALUATION METHODS FOR ELECTRICITY DYNAMIC PRICING SYSTEM AND ENERGY SAVING TECHNOLOGIES

experienced in annual time increments during the project life with consideration for the time value of money. As for energy system, the good accuracy of life cycle cost is difficult to obtain owing to the complicated calculation method and the low accuracy data. Therefore, the LCC almost not be used in the planning and initial design stage. Eq. (5-5) presents the calculation method of life cycle cost.

$$LCC = C_e F_p + \sum_{j=1}^n F_p (C_r + C_{oj} I_{oj} + C_{mj}) + S F_p \quad (5-5)$$

$C_e$  = Initial cost of planning

$F_p$  = Conversion Rate

$C_r$  = Maintenance fee

$C_{oj}$  = Annual operating cost of j year

$I_{oj}$  = Inflation rate for j years

$C_{mj}$  = Annual maintenance fee of j year

$n$  = Lifetime

$S$  = Residual value

### ✧ Environmental performance

The emissions of greenhouse gases (GHGs) and the air pollutant are frequently be used to evaluate the environmental performance of the energy system which equipped with energy saving technologies. GHGs are those gaseous constituents of the atmosphere, both natural and anthropogenic, that absorbs and emits the sun's radiation (the greenhouse effect). The GHGs mentioned in this chapter mainly refers to carbon dioxide (CO<sub>2</sub>). Air pollutants result in smog and acid rain, and have impacts on human health and the environment. It includes particulate matter (PM), ground-level ozone (O<sub>3</sub>) and sulphur oxides (SO<sub>x</sub>). However, we don't evaluate the air pollutants in this chapter.

## 5.3 Methodology for evaluation

### 5.3.1 Description of the alternative energy system

The alternative energy system of this research refers to the energy system which equipped with different energy saving technologies, such as photovoltaic (PV), storage battery (SB) and distributed energy system (DES) in the various building sector. In particular, these systems interact with individual buildings, or a cluster of buildings connected via a local electric grid. In this thesis, PV and SB are provided for individual buildings owing to that these two technologies are common, convenient and relatively easy to deploy, while DES is provided to the area owing to the complex load characteristics of the area. The energy system with the basic following characteristics is suggested as a possible alternative energy system:

- ① Gas boiler, providing heating load;
- ② Absorption refrigerator, providing cooling and heating load;
- ③ Electricity supply from the power system through the electric grid.

Generally, the alternative energy system contains the cogeneration device with the other components of the system (e.g. storage battery), and with other energy supply parts such as heat pumps and fuel cells, or with renewable energy sources (e.g. photovoltaic), is evaluated in terms of selected three criteria, such as the primary energy demand, CO<sub>2</sub> emissions, and operating costs.

## CHAPTER FIVE: EVALUATION METHODS FOR ELECTRICITY DYNAMIC PRICING SYSTEM AND ENERGY SAVING TECHNOLOGIES

The energy structure of alternative energy system which equipped with DES has been explained emphatically. We will take this energy system as an example to do the following related discussion.

In recent years, DES has contributed a lot in energy saving performance and environmental protection, and also has created great merits in economic aspect, for example, it makes it possible to withdraw the initial investment which was invested in early stage. Therefore, in Japan, the input volume of power generation equipments which utilize distributed energy system, such as gas co-generation system, etc., tends to increase year by year. What's more, because of the East Japan Earthquake, people have a higher cognition about the safe support of energy system, and pay more attention to the ability of disaster prevention of distributed energy system. In this paper, a combination of the dynamic pricing and distributed energy system was assumed to discuss both the DP influence on the planning of energy system and how the DES affects the DP introduction effect. The conventional energy system and distributed energy system were shown in figure 5-5 and figure 5-6.

The electric power of DES is supplied from four kinds of ways—gas engine (GE), fuel cell (FC), photovoltaic cell (PV) and commercial power. The air conditioning is supplied from three kinds of ways—waste heat recovery absorption refrigerator (ABS), turbo cooling machine (TC), and heat pump (HP). The exhaust heat supply the hot water load, and gas boiler plays a supporting role. As for the conventional system, electricity load is supplied by utility grid. Cooling and heating demand is supplied by absorption refrigerator. Hot water demand is supplied by boiler.

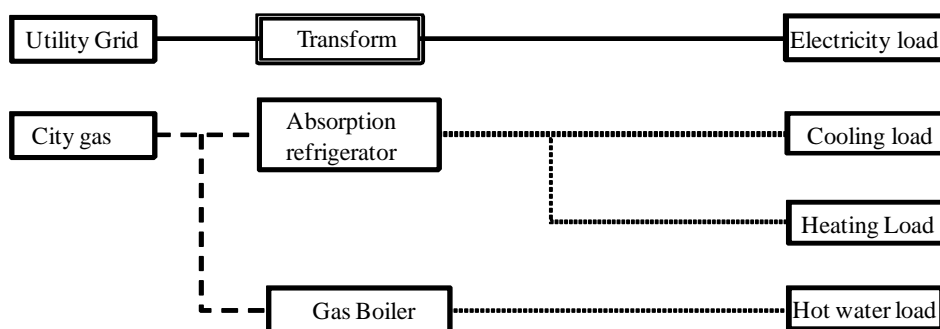

Figure 5-5 Description of conventional energy system

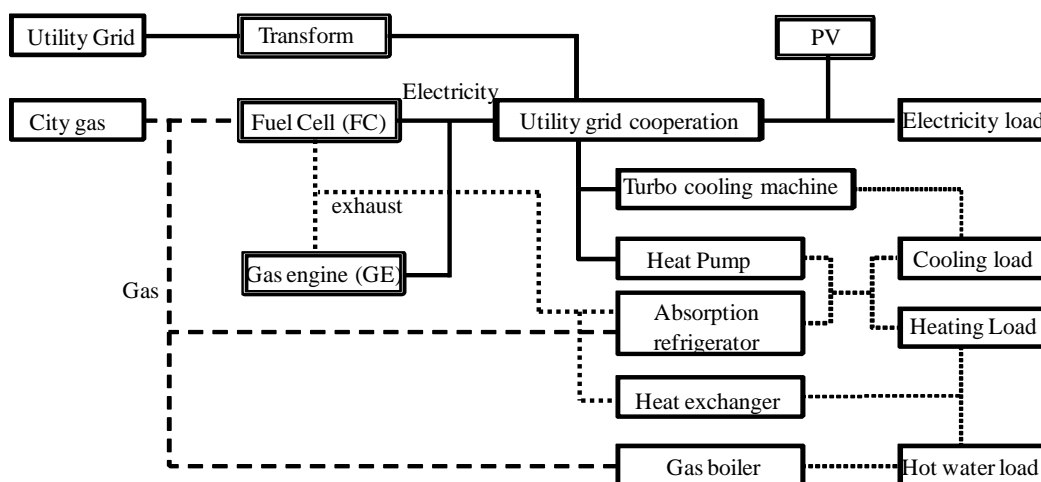

Figure 5-6 Description of distributed energy system

### 5.3.2 Methodology for evaluating electricity dynamic pricing system

The objective of each kind of dynamic pricing is to reduce electricity consumption by providing consumers incentives to shift or reduce their electricity consumption in peak period. The reduction value affected by many items, such as temperature, appliance efficiency and building characteristics. Figure 5-7 shows the flow chart of evaluating electricity dynamic pricing system. First, electricity data have been collected from smart meter through CEMS. The collection of target data allowed for the electricity consumption of consumers to be investigated from both hourly electricity usage and monthly electricity usage. With the establishment of database of electricity consumption for each building, a comprehensive analysis of power consumption could be realized. Meanwhile, the relationship among electricity consumption, temperature, building characteristics and appliance also can be discussed. Through the comparison between the electricity consumption of treatment group and control group (baseline group), load reduction effect of DP can be concluded

### 5.3.3 Methodology for evaluating energy saving technologies

#### ✧ Evaluation step of AES in individual building

In this section, PV was selected as a representative to explain the evaluation methodology. Figure 5-8 is a flow chart that illustrating the evaluation structure of photovoltaic technology. The basic data of the model includes three parts: hourly irradiation data of the objective research area, hourly electricity load data and technology data of the demand side in PV systems and market data for the cost related section (e.g. electricity tariff, etc.). When the specific scale of PV system has been determined, the model can evaluate the economical effects. Meanwhile, this model also can analyze the effects of PV capacity and PV buy-back price on the annual energy cost of target consumers.

#### ✧ Evaluation step of AES in the area

The effectiveness of DES is not shown without any condition. It is difficult to make sure the optimal allocation of DER facilities due to the complex factors involved in the system. Therefore, it is necessary to discuss how to balance these factors during the integration stage of DER system. Figure 5-9 illustrated the evaluation step of distributed energy system under the condition of using dynamic pricing. In order to reach the best introduction effect of the DER system, the mixed-integer linear programming (MILP) model is developed using the GAMS. The input data is divided into the following categories: demand site information (electric, heat load, etc.), energy charge information (gas, electricity tariff, etc.) and technical information (capacity, efficiency, investing cost, etc). After the optimal calculation, the most suitable combination of facilities can be obtained (structure of energy system; equipment type, number and capacity), meanwhile, the economic, primary energy and environmental effects can be also deduced.

In most cases, energy saving, economy performance and environment performance are the main objectives of the plan of distributed power source and heat source system. In this paper, in order to evaluate the effect of introducing distributed energy resource (DER) systems, we set the conventional system as a comparison energy system (CES), and the objective of this model is to minimize the annual cost after introduced distributed energy system under the condition of fuel prices either electricity or gas prices.



CHAPTER FIVE: EVALUATION METHODS FOR ELECTRICITY DYNAMIC PRICING SYSTEM AND ENERGY SAVING TECHNOLOGIES

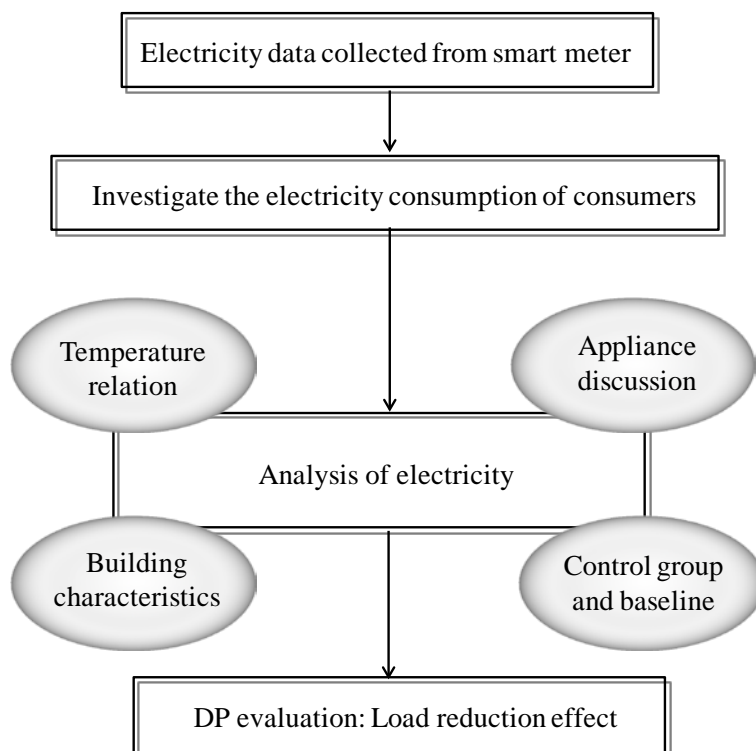

Figure 5-7 Flow Chart of evaluation model of electricity dynamic pricing system

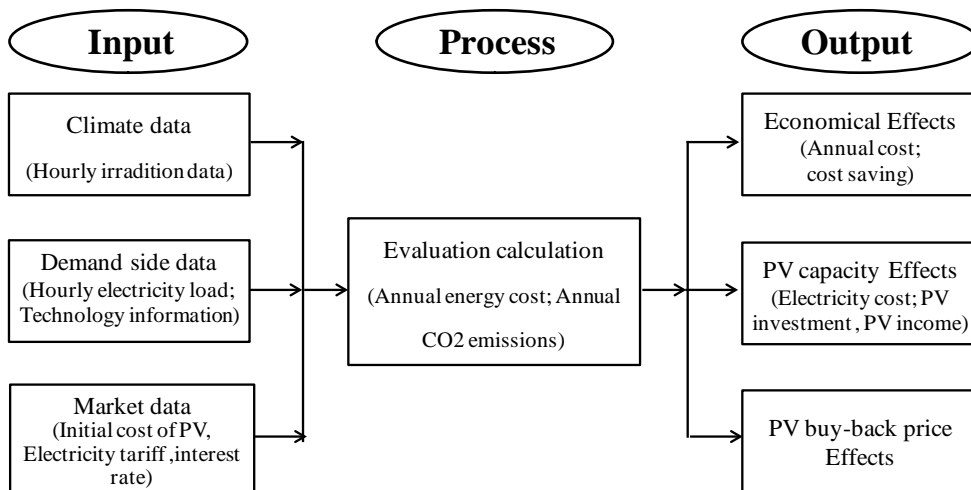

Figure 5-8 Flow Chart of evaluation model of energy saving technology

CHAPTER FIVE: EVALUATION METHODS FOR ELECTRICITY DYNAMIC PRICING SYSTEM AND ENERGY SAVING TECHNOLOGIES

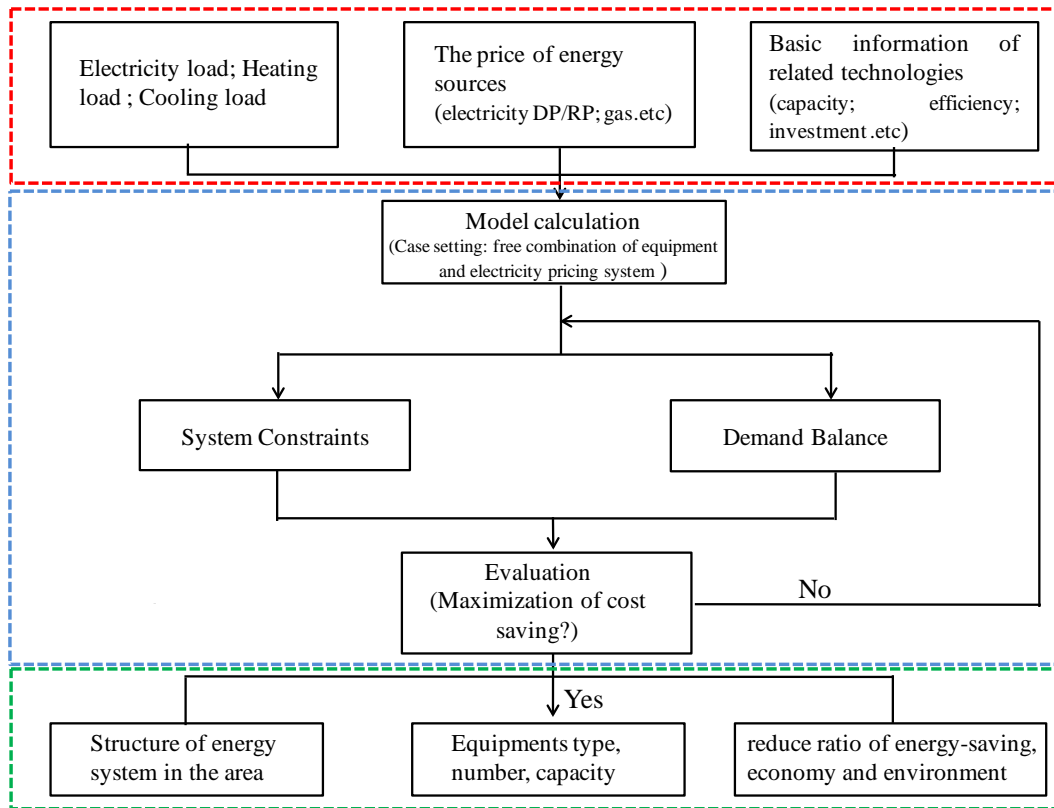

Figure 5-9 Evaluation step of distributed energy system

### 5.4 Assessment criteria

Three criteria are used to evaluate the performance of the introduction of energy saving technologies in various buildings, cost saving ratio (CSR), primary energy saving ratio (PESR) and CO<sub>2</sub> emissions reduction ratio (CERR). A simplified approach to evaluate these three assessment criteria is through comparing, with respect to a specific time period (typically an annual basis), the primary energy consumption, annual energy cost, and CO<sub>2</sub> emissions with those of a conventional system. This energy process was performed while consider the delivered and introduced energy amounts, as well as the output energy and user demands, as illustrated in figure 5-10.

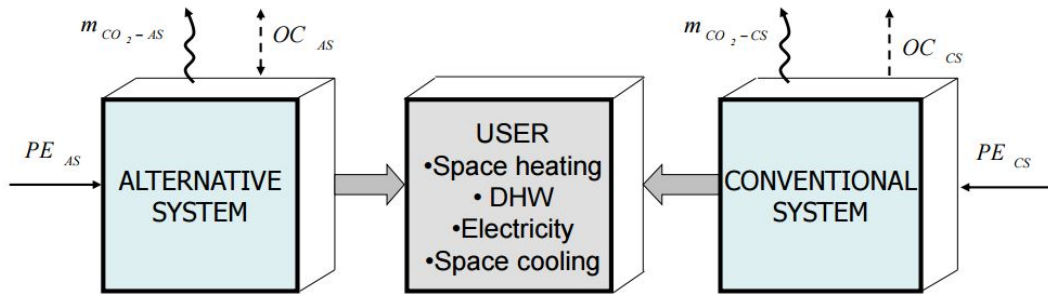

Figure 5-10 Energy flow of alternative energy system and conventional energy system  
(\*PE refers to primary energy; CS refers to conventional system; AS refers to alternative system)

In this paper, the consideration of energy characteristics was calculated according to the unit primary energy consumption issued by Kyushu area throughout a one-year (8760 period hrs). In order to make a good combination between electricity dynamic pricing and energy saving technologies, the operation of cogeneration system was assumed to track the electricity need corresponding to the reasonable solutions for primary energy saving and maximum environmental benefits. Three evaluation indexes will be introduced respectively in the following section.

#### 5.4.1 Assessment for economy performance

Economic performance is considered as one of the most cited reasons of introducing energy saving technologies. The economic assessment provides information on how the economic resources (investments, electricity, etc.) are used to meet the customer requirements. Generally, there are two ways for the assessment of the economic performance: static analysis and dynamic analysis. The former one is a simple economic analysis method which does not consider the time value of the money and the lifetime of the equipments. On the contrary, the later one pays enough attention to the time value of the money which is indicated by the interest rate. As is known to all, most of energy saving technologies has usually higher initial investment compared with the conventional system. Therefore, in economic evaluation, an important index, cost saving ratio (CSR), has been employed. The calculation method of it illustrated as shown in Eq. (5-6).

$$CSR = \frac{Tot\ Cost_{conv} - Tot\ Cost}{Tot\ Cost_{conv}} \times 100 = \left( 1 - \frac{Tot\ Cost}{Tot\ Cost_{conv}} \right) \times 100 \quad (5-6)$$

$$Tot\ Cost_{conv} = Annual\ cost\ of\ CES$$

$$Tot\ Cost = Annual\ cost\ of\ DES$$

$$CSR = Annual\ cost\ reduction\ rate$$

**CHAPTER FIVE: EVALUATION METHODS FOR ELECTRICITY DYNAMIC PRICING  
SYSTEM AND ENERGY SAVING TECHNOLOGIES**

Where,  $TotCost$  and  $TotCost_{conv}$  present the annual electricity cost of conventional energy system and alternative energy system, respectively. Due to the deployment of PV contains selling electricity to utility grid sometimes and DES contains many different generation and heating facilities, therefore, we select these two technologies to explain the calculation method of their total yearly cost. It can both be evaluated as follow equations:

✧ Alternative system of PV

$$TotCost_{PV} = C_{pur} + C_{sys} - C_{sal} \quad (5-7)$$

Where  $C_{pur}$  is the cost for using electricity power from utility grid;  $C_{sys}$  is year initial investment cost of the system;  $C_{sal}$  is the income from selling electricity back into the grid.  $C_{pur}$  was calculated by Eq. (5-8).

$$C_{pur} = \sum_d \sum_h EL_{pur,d,h} P_{ele,h} + \sum_m P_{base} \quad (5-8)$$

Where,

$d, h, m$  present the days in a month, hours in a day and months in a year respectively.  $EL_{pur,d,h}$  presents electricity load;

$$C_{sys} = C_{ini} \cdot Cap \cdot \frac{I}{1 - \frac{1}{(1+I)^T}} \quad (5-9)$$

$C_{sys}$  was calculated by Eq. (5-9). As expressed in Eq. (5-9),  $C_{sys}$  is decided by spreading the initial cost of equipment across the life time of that equipment and the discount rate. Where,  $C_{ini}$  presents the initial cost of selected equipment;  $Cap$  presents the capacity of selected equipment;  $I$  presents the interest rate;  $T$  presents the expected life time of selected equipment.

$$C_{sal} = \sum_d \sum_h EL_{sal,d,h} P_{sal} \quad (5-10)$$

$C_{sal}$  was calculated by Eq. (5-10). Where,  $EL_{sal,d,h}$  presents the electricity sale to the grid;  $P_{sal}$  presents the buy-back price of utility grid.

✧ Alternative system of DES

$$TotCost = C_{Gen} + C_{Elec} + C_{Heat} + C_{Gas} \quad (5-11)$$

$$C_{Gen} = \sum_i GenInv_i \times Der\ cost_i \times GF_i \quad (5-12)$$

$$C_{Elec} = \sum_m (EBase_m \times BillingE) + \sum_m \sum_t \sum_h (DePur_{m,t,h} \times \lambda_{m,t} \times Eprice_m) \quad (5-13)$$

$$C_{Heat} = \sum_u \sum_j HeatInv_{u,j} \times Heat\ cost_j \times HF_j \quad (5-14)$$

$$C_{Gas} = \sum_m GBase_m + \sum_m (GBaseflow_m \times BillingG) + \sum_m \sum_i \sum_t \sum_h (GenL_{i,m,t,h} \times Derconv_i \times \lambda_{m,t} / Gconv \times Gprice_m) + \sum_m \sum_j \sum_u \sum_t \sum_h (HeatGP_{j,u,m,t,h} \times Hconv \times HGP_j \times \lambda_{m,t} / Gconv \times Gprice_m) \quad (5-15)$$

**CHAPTER FIVE: EVALUATION METHODS FOR ELECTRICITY DYNAMIC PRICING  
SYSTEM AND ENERGY SAVING TECHNOLOGIES**

$$GF_i = IRate / (1 - \frac{1}{(1 + IRate)^{Derlife_i}}) \quad (5-16)$$

$$HF_j = IRate / (1 - \frac{1}{(1 + IRate)^{Heatlife_j}}) \quad (5-17)$$

The definition of each parameter can be shown in attached list.

The main constraints used in economy model are electricity and thermal balance between the demand and supply, as illustrated in Eq.(6)~(7).

$$Eload_{m,t,h} = \sum_i GenL_{i,m,t,h} + DePur_{m,t,h} - \sum_u \sum_j (HeatEP_{u,j,m,t,h} \times HEP_j) \quad (5-18)$$

$$Hload_{u,m,t,h} = \sum_j (HeatGP_{j,u,m,t,h} \times HGP_j \times Heacop_{u,j,m} + HeatEP_{j,u,m,t,h} \times HEP_j \times Heatcop_{u,j,m} + \beta_{u,j} \times Re cHeat_{j,u,m,t,h} \times Heatcop_{u,j,m}) + \gamma \times Re HEX_{u,m,t,h} \times HEXRA_{u,m} \quad (5-19)$$

The definition of each parameter was also shown in attached list in this chapter.

✧ Fuel tariff

Fuel tariff which contains electricity tariffs and gas tariffs are essential parameters that need to consider the calculation of analyzing the economic performance of the alternative energy system regarding to the effect of running cost for the cogeneration system and also for the conventional system. The database of fuel tariff which used in alternative energy system was created as what is shown in the table 5-2 by reference to the contracts of power company and gas company. Each energy charge is composed of the basic charge and meter rate charge. The power charge adopts the type A for business. As for gas charge, type A contract for air-conditioner was provided to CES and the first type of total energy system contract is adopted in AES.

Table 5-2 Fuel charge information

	Configuration of charge	CES	AES
Electricity	Basic Charge	2008.8	1953
	Meter rate charge (summer) (yen/ kW)	12.72	10.59
	Meter rate charge (others) (yen/ kW)	11.81	9.7
Gas	Fixed basic charge (winter) (yen/ month)	72360	79920
	Fixed basic charge (others) (yen/ month)	43200	79920
	Flow basic charge (winter) (yen/ m <sup>3</sup> )	4752	810
	Flow basic charge (others) (yen/ m <sup>3</sup> )	853.2	810
	Meter rate charge (yen/ m <sup>3</sup> )	64.14	61.98

**5.4.2 Assessment for energy performance**

The alternative energy system with cogeneration device and renewable resources have the main benefit of that system is the possible to save primary energy consumption with respect to the system have equal energy outputs with conventional energy system. Therefore, the evaluation of the energy saving performance is one of the most important aspects of the alternative energy system. Primary energy saving ratio (PESR) was used to estimate the energy saving performance, which is defined as the rate of the energy savings of the alternative energy system to that of

## CHAPTER FIVE: EVALUATION METHODS FOR ELECTRICITY DYNAMIC PRICING SYSTEM AND ENERGY SAVING TECHNOLOGIES

conventional energy system. PESR is defined as Eq. (5-20):

$$PESR = \frac{TotPEC_{conv} - TotPEC}{TotPEC_{conv}} \times 100 = \left( 1 - \frac{TotPEC}{TotPEC_{conv}} \right) \times 100 \quad (5-20)$$

$TotPEC_{conv}$  = Primary energy consumption of CES

$TotPEC$  = Primary energy consumption of DES

$PESR$  = Primary energy saving rate

Where,  $TotPEC$  and  $TotPEC_{conv}$  present the annual electricity cost of conventional energy system and alternative energy system, respectively; The calculation method of primary energy consumption of DES can be evaluated as follow equations:

$$TotPEC = E_{Gen} + E_{Elec} + E_{Heat} \quad (5-21)$$

$$E_{Gen} = \sum_i \sum_m \sum_t \sum_h (GenL_{i,m,t,h} \times Derconv_i \times \lambda_{m,t}) \quad (5-22)$$

$$E_{Elec} = \sum_m \sum_t \sum_h (Depur_{m,t,h} \times Econv \times \lambda_{m,t}) \quad (5-23)$$

$$E_{Heat} = \sum_j \sum_u \sum_m \sum_t \sum_h (HeatGP_{j,u,m,t,h} \times Hconv \times HGP_j \times \lambda_{m,t}) \quad (5-24)$$

The definition of each parameter was also shown in attached list in this chapter.

### 5.4.3 Assessment for environmental performance

Besides, considerable environmental benefit is another incentive for the introduction of the energy saving technologies. In fact, a global balance seems correct only with respect to greenhouse gas and ozone depletion emissions. On the contrary, greenhouse gas and related emissions that have a local impact (within a radius of hundreds of kilometers from the source) on the surrounding environment, as well as people's health, such as NO<sub>x</sub>, CO, SO<sub>x</sub> and PM. Therefore, the environmental performance required a special analysis.

In terms of the environmental assessment of alternative energy system, although local environmental pollutants (SO<sub>x</sub> and NO<sub>x</sub>) can be also reduced, only CO<sub>2</sub> emissions reduction is included in the following analysis for simplicity. In this study, it is assessed using the CO<sub>2</sub> emissions reduction ratio (CERR) which is defined as the ratio of the reduced CO<sub>2</sub> emissions (the difference between CO<sub>2</sub> emissions in the conventional system and new system). The calculation method CERR as shown in Eq. (5-25):

$$CERR = \frac{TotCE_{conv} - TotCE}{TotCE_{conv}} \times 100 = \left( 1 - \frac{TotCE}{TotCE_{conv}} \right) \times 100 \quad (5-25)$$

$TotCE_{conv}$  = CO<sub>2</sub> emission of CES

$TotCE$  = CO<sub>2</sub> emission of DES

$CERR$  = CO<sub>2</sub> emission reduction rate

$$TotCE = \frac{E_{Gen} + E_{Heat}}{G_{conv}} \times GCE + E_{Elec} / Econv \times ECE \quad (5-7)$$

The definition of each parameter can be shown in attached list.

Due to the energy performance is strongly related to the environmental performance, all of them are decided by the primary energy consumption. Therefore, we just take the environmental performance as an example to have a discussion.

## CHAPTER FIVE: EVALUATION METHODS FOR ELECTRICITY DYNAMIC PRICING SYSTEM AND ENERGY SAVING TECHNOLOGIES

### 5.5 Summary

In this chapter, the evaluation system for the utilization of electricity dynamic pricing and energy saving technology are proposed to support its well introduction and deployment, which is meaningful to the establishment of sustainable energy system and low carbon society.

Firstly, the overview of evaluation method for electricity dynamic pricing and energy saving technology are introduced. It noted that there are three directions when evaluating DP systems, evaluate DP from participants (participants' satisfaction, energy use change and energy bill impacts), evaluate DP from non-participants (DP influence on wholesale market price) and evaluate DP from market side (net benefits and generator's investment behavior). Moreover, this part have pointed that people mainly evaluate the introduction effect of energy saving technology through three aspects, economy performance, energy saving performance and environmental performance, meanwhile, have listed some related evaluation indexes.

Then, alternative energy system which equipped with different energy saving technologies have been described. The evaluation methodologies for electricity dynamic pricing and energy saving technology have also been illustrated in detail. Where, in terms of the evaluation of energy saving technology, photovoltaic and distributed energy system has been paid special attention as the representative of alternative energy system. The evaluation step of the photovoltaic and distributed system have all been explained by considering the factors of load information, market information, and technical information.

Finally, the main assessment criteria (namely, cost saving ratio, primary energy saving ratio, as well as CO<sub>2</sub> emissions reduction ratio) have been introduced to estimate the overall performance of introducing energy saving technologies into the different alternative energy system for various individual buildings and the area. The development of these three criteria contributes to evaluating the feasibility of the introduction of energy saving technologies into the building which can replace the conventional system.

## CHAPTER FIVE: EVALUATION METHODS FOR ELECTRICITY DYNAMIC PRICING SYSTEM AND ENERGY SAVING TECHNOLOGIES

### Attached list

#### Definition of parameters

$h$	=Hour (1, 2...24)
$i$	=Power generation technology
$j$	=Heat source technology
$m$	=Month (1, 2...12)
$t$	=Types of days (weekdays, holidays)
$u$	=Uses of heat source technology
$E_{Gen}$	=Annual primary energy consumption of power generation technology
$E_{Elec}$	=Annual primary energy consumption of system power
$E_{Heat}$	=Annual primary energy consumption of heat source technology
$GenL_{i,m,t,h}$	=Power generation amount according to time of power generation technology
$Derconv_i$	=Primary energy consumption when power generate is at 1kWh of power generation technology
$\lambda_{m,t}$	=Days of weekdays and holidays according to month
$DePur_{...}$	=Purchase quantity of power according to time from system power
$Econv$	=Conversion coefficient of heating value of system power
$HeatGP_{j,u,m,t,h}$	=Purchase quantity of gas of heat source technology
$Hconv$	=Primary energy consumption from the heat of 1kWh
$HGP_i$	=Determination of gas utilization of heat source technology
$C_{Gen}$	=Initial investment of power generation technology
$C_{Heat}$	=Initial investment of heat source technology
$C_{Gas}$	=Annual gas charge
$C_{Elec}$	=Annual power charge
$GenInv_i$	=Introduced quantity of power generation technology
$Der cost_i$	=Initial investment of power generation technology
$GF_i$	=Annuity coefficient of power generation technology
$HeatInv_{u,i}$	=Introduced quantity of heat source technology according to use
$Heat cost_i$	=Initial investment of heat source technology
$HF_i$	=Annuity coefficient of heat source technology
$GBase_m$	=Fixed basic charge of gas
$GBaseflow_m$	=Flow basic charge of gas
$Gprice_m$	=Meter rate charge of gas
$BillingG$	=Contract gas
$BillingE$	=Contract power
$Gconv$	=Conversion coefficient of heating value of city gas
$EBase_m$	=Basic charge for power



## CHAPTER FIVE: EVALUATION METHODS FOR ELECTRICITY DYNAMIC PRICING SYSTEM AND ENERGY SAVING TECHNOLOGIES

$E_{price_m}$	=Meter rate charge for power
$IRATE$	Rate of investment
$Derlife_i$	=Lifetime of power generation technology
$Heatlife_i$	=Lifetime of heat source technology
$Eload_{m,t,h}$	=electricity load per hour in a year
$Hload_{m,t,h,u}$	= thermal load per hour in a year
$\beta_{u,j}$	=utilization efficiency of recovered heat for heating equipment
$Heatcop_{j,u}$	= COP of heating equipment
$ReHeat_{j,u,m,t,h}$	=heat recovered by heating equipment
$\gamma$	=utilization efficiency of recovered heat for heat exchanger
$ReHEX_{u,m,t,h}$	=heat recovered by heat exchanger
$HEXRA_u$	=efficiency of heat exchanger

## CHAPTER FIVE: EVALUATION METHODS FOR ELECTRICITY DYNAMIC PRICING SYSTEM AND ENERGY SAVING TECHNOLOGIES

### REERENCE

- [1] Mohamed E. El-hawary. The Smart Grid—State-of-the-art and Future Trend. *Electric Power Components and Systems*. 2014, 42: 3-4, 239-250.
- [2] Berger, Lars T.; Iniewski, Krzysztof, eds. *Smart Grid - Applications, Communications and Security*. April 2012.
- [3] Anthony Star, Marjorie Isaacson, Larry Kotewa. Evaluating Residential Real-Time Pricing: Connecting Customer Response to Energy Market Impacts. CNT Energy. Available at: <http://www.elevateenergy.org/wp/wp-content/uploads/EvaluatingResidentialRealTimePricing.pdf>
- [4] Jun Wei Chua, Anand Raghunathan, Niraj K. Jha. An Evaluation of Energy-Saving Technologies for Residential Purposes. *Power and Energy Society General Meeting, 2010 IEEE*
- [5] H. Paul Barringer. A Life Cycle Cost Summary. *International Conference of Maintenance Societies (ICOMS®-2003)*.
- [6] Vivek Soni, A.P. Dash, S.P. Singh, D.K. Banwet. Life Cycle Costing Analysis of Energy Options: In Search of Better Decisions towards Sustainability in Indian Power & Energy Sector. *Global Journal of Management and Business Research Administration and Management*. Vol.14 Issue 1, Version 1.0, 2014.
- [7] Assessment of the Environmental Performance of Solar Photovoltaic Technologies, A report funded under the Clean Energy Fund. Environment Canada, in partnership with Natural Resources Canada's Canmet ENERGY. Available at: [https://www.ec.gc.ca/scitech/B53B14DE-034C-457B-8B2B-39AFCFED04E6/ForContractor\\_721\\_Solar\\_Photovoltaic\\_Technology\\_e\\_09%20FINAL-update%202-s.pdf](https://www.ec.gc.ca/scitech/B53B14DE-034C-457B-8B2B-39AFCFED04E6/ForContractor_721_Solar_Photovoltaic_Technology_e_09%20FINAL-update%202-s.pdf).
- [8] Dorer V., Weber A., Methodologies for the Performance Assessment of Residential Cogeneration Systems, A Report of Subtask C of FC+COGEN-SIM: The Simulation of Building-Integrated Fuel Cell and Other Cogeneration Systems, Annex 42 of the International Energy Agency Energy Conservation in Buildings and Community Systems Programme, 2007.
- [9] Angrisani G., Roselli C., Sasso M., Distributed microtrigeneration systems, *Progress in Energy and Combustion Science* 38 (2012) 502–521.
- [10] Roselli C., Sasso M., Sibilio S., Tzscheutschler P., Experimental analysis of microgenerators based on different prime movers, *Energy and Buildings* 43 (2011) 796–804.
- [11] Maurizio Sasso, Evgeniy Entchev, Peter Tzscheutschler. Methodologies for the Performance Assessment of Micro Hybrid Polygeneration Systems. *Energy in Buildings and Communities Programme* October, 2014.

**CHAPTER SIX: ANALYSIS OF THE EFFECTS OF ELECTRICITY  
DYNAMIC PRICING ON THE COST PERFORMANCE OF BUILDINGS IN  
PRESENT SCENARIO AND DEMAND RESPONSE SCENARIO**

6.1 Introduction

6.2 Effects of DP on the Cost Performance of Buildings in Present Scenario

6.2.1 The case of residential house

6.2.1.1 Electricity load of residential house

6.2.1.2 Electricity price of residential house

6.2.1.3 Cost performance of DP in residential house

6.2.2 The case of hospital

6.2.2.1 Electricity load of hospital

6.2.2.2 Electricity price of hospital

6.2.2.3 Cost performance of DP in hospital

6.2.3 The case of office

6.2.3.1 Electricity load of office

6.2.3.2 Electricity price of office

6.2.3.3 Cost performance of DP in office

6.2.4 The case of hotel

6.2.4.1 Electricity load of hotel

6.2.4.2 Electricity price of hotel

6.2.4.3 Cost performance of DP in hotel

6.3 Effects of DP on the Cost Performance of Buildings in DR Scenario

6.3.1 The case of residential house

6.3.1.1 Introduction of energy saving actions in residential house

6.3.1.2 Electricity cost reduction effect of different actions

6.3.2 The case of hospital

6.3.2.1 Introduction of energy saving actions in hospital

6.3.2.2 Electricity cost reduction effect of different actions

6.3.3 The case of office

6.3.3.1 Introduction of energy saving actions in office

6.3.3.2 Electricity cost reduction effect of different actions

6.3.4 The case of hotel

6.3.4.1 Introduction of energy saving actions in hotel

6.3.4.2 Electricity cost reduction effect of different actions

6.4 Summary



## CHAPTER SIX: ANALYSIS OF THE EFFECTS OF DYNAMIC PRICING AND ENERGY SAVING TECHNOLOGIES ON THE COST PERFORMANCE IN DIFFERENT TYPES OF BUILDING

### 6.1 Introduction

With the incessant development of the world economy and the improvement of people's living standards, the power grid's operating system has stepped into a new historical stage. In order to cater to the change, new electricity price system need to help utility grid to meet consumers' electricity demand, meanwhile, realize the energy resources reduction which results in the appearance of electricity dynamic pricing.

The review of existing researches explains the tendency of the development of electricity dynamic pricing. These researches always focused on the electricity load reduction performance of dynamic pricing and how to realize more effective pricing system. What's more, most literatures just explore the implement of electricity dynamic pricing in buildings from load scheduling system and load control system, ignore the investigation of the effect of the introduction of dynamic pricing in buildings. This chapter concentrates on the study of dynamic price's cost performance on different kind of buildings from two different perspectives. One is considering the cost performance of DP without demand response and another one is that consumers will have simple demand response when using DP.

Actually, people usually concentrates on the problem that how can the consumers respond to the electricity dynamic price well in previous studies. For this purpose, different methods are explored to guide consumers to reduce their electricity consumption in peak period reasonably. The hotspot of their researches is to extremely improve the degree of consumers' demand-response while ignored the living comforts and working habits of the consumers. On the contrary, this chapter investigates the introduction of DP from the opposite viewpoint. As all we known, with the speed development of smart meters, it is rapidly becoming both technically practical and economically attractive to use dynamic price in a whole area, the widely regional use of dynamic price is the inevitable trend in the future. In that time, if some kinds of consumers do not want to change their living habits or they must use electricity in peak hours which has higher electricity price, whether using dynamic price is a good option for them is still need to be discussed. Therefore, in terms of this issue, this chapter assumes that the electricity load of consumers in peak period remains initial conditions or has tiny change for ensuring their original living standards and working habits, intends to investigate the economy effect of electricity dynamic pricing system on different kind of buildings.

Another essential part of this chapter is that it wants to study the cost performance of electricity dynamic pricing under the condition that consumer will take some simple energy saving actions during the high price periods. As for this part, the chapter assumes to introduce several energy saving actions into different buildings to see its cost reduction effect. All selected energy saving actions is easy for consumers to implement. Through this kind of method, this chapter want to give consumers some suggest and reference to adjust their energy consumption patterns without influencing normal life style of consumers.

## CHAPTER SIX: ANALYSIS OF THE EFFECTS OF DYNAMIC PRICING AND ENERGY SAVING TECHNOLOGIES ON THE COST PERFORMANCE IN DIFFERENT TYPES OF BUILDING

### 6.2 Effects of DP on the Cost Performance of Buildings in present Scenario

In this section, Unit energy consumption in Kyushu area has been used to estimate energy loads of different buildings. According to the common building scale, each kind of building has been endowed with one fixed area value.

#### 6.2.1 The case of residential house

As for the case of residential house, in this paper, a two-story detached house with floor area 183m<sup>2</sup> has been selected as case study.

##### 6.2.1.1 Electricity load of residential house

The situation of residents' electricity load in different month has been shown in Figure 6-1. It presents the load changes within one day of residential users in three representative months. According to the figure, we can know that, in January, the electricity load of residential consumers decreased slowly from 1:00 to 4:00. Then it began to rise slowly from 5:00 to 7:00, owing to the residents' daily activities in the morning. About 8:00, the load reached at morning peak period, after that the load has fallen slightly. In the period from 16:00 to 19:00, the load curve continued to rise, reached an evening peak at 19:00 o'clock and contained until 21:00 o'clock. Then it began to fall, fell to a low point at 5:00 o'clock. The maximum load in January is 4.74kW, the minimum load is 0.69kW, and the peak-vale difference is 4.05kW. In August, residents' electricity load has increased from morning 8:00 o'clock, turn on the household appliances resulted in the load reached at 1.23kW. After that, due to the high temperature in summer, cooling load began to increase what made the load rise to a higher level. From 18:00, most people went off work, household appliances' opening rate increased again, load continued to climb. At 20:00, night lighting gradually open, the electricity load reached maximum at 21:00.

##### 6.2.1.2 Electricity price of residential house

In this paper, there are two primary pricing methods, one is regular price (RP), and another one is dynamic price (DP). As table 6-1 shows, for RP, the price is 8JPY/kWh for 1:00 to 7:00 and 22:00 to 24:00, and 25JPY/kWh for 8:00 to 21:00. For DP, the price is 6JPY/kWh for 1:00 to 7:00 and 22:00 to 24:00, 18.75JPY/kWh for 8:00 to 12:00 and 16:00 to 21:00, and 150JPY/kWh for 12:00 to 15:00. Compared with regular price, dynamic price in the period of 1:00-7:00, 22:00-24:00, 8:00-12:00 and 16:00-21:00 is declined in the proportion of 25%. As figure 6-2 shown, dynamic price from 12:00 to 15:00 is 6 times higher than the price in other time period.

Table 6-1 Electricity information of residential house

(Source: Kyushu electricity)

		RP	DP
Basic charge (JPY/month)		1155	1155
Volume charge (JPY/kWh)	Off peak (1:00-7:00; 22:00-24:00)	8	6
	Middle (8:00-12:00; 16:00-21:00)	25	18.75
	On peak (12:00-15:00)	25	150

**CHAPTER SIX: ANALYSIS OF THE EFFECTS OF DYNAMIC PRICING  
AND ENERGY SAVING TECHNOLOGIES ON THE COST PERFORMANCE  
IN DIFFERENT TYPES OF BUILDING**

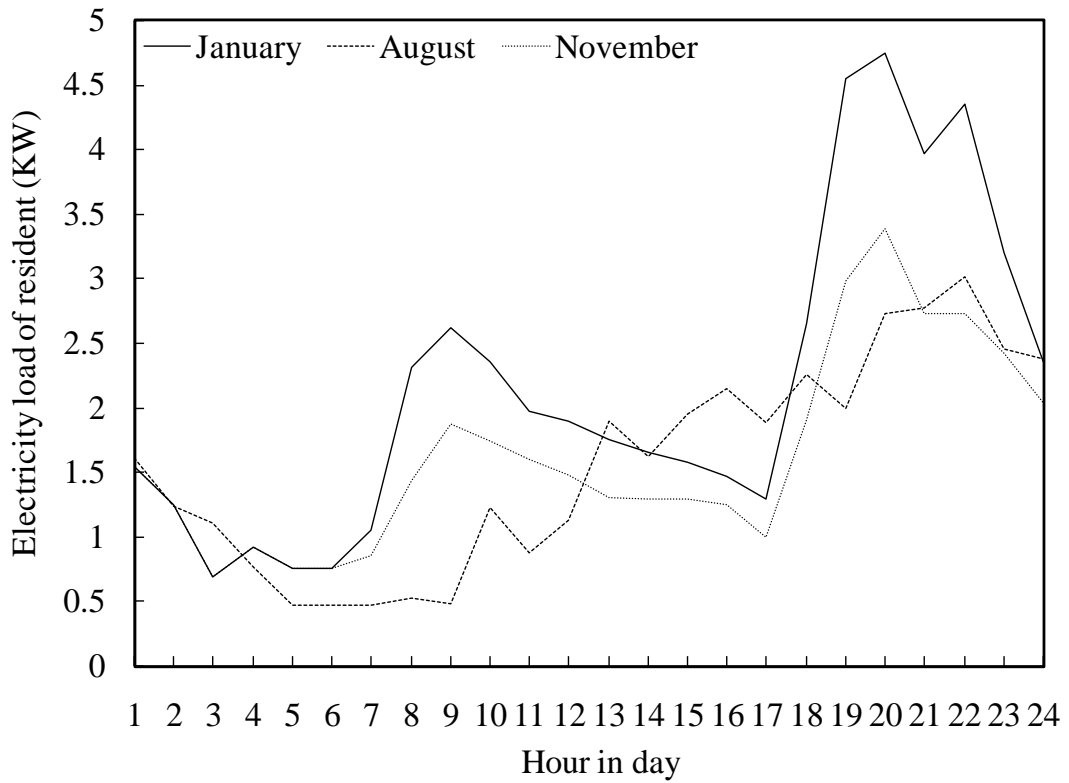

Figure 6-1 Hourly electricity load of residential consumers

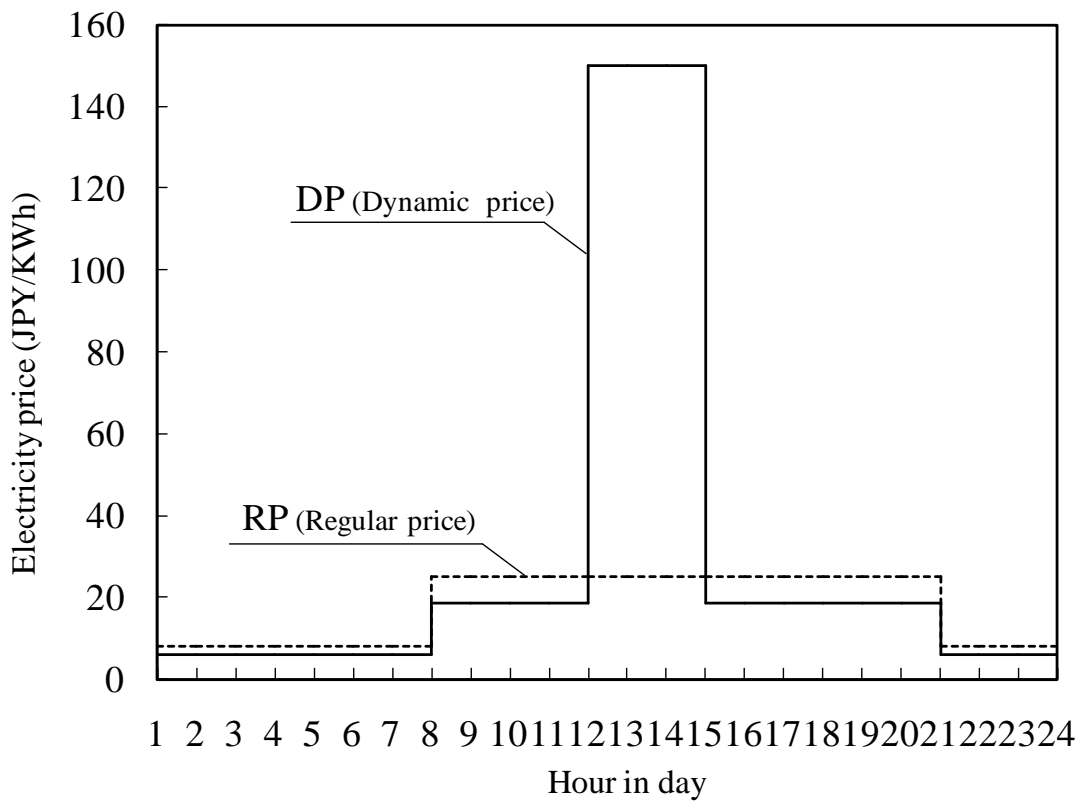

Figure 6-2 Electricity price of residential consumers in a day

**CHAPTER SIX: ANALYSIS OF THE EFFECTS OF DYNAMIC PRICING  
AND ENERGY SAVING TECHNOLOGIES ON THE COST PERFORMANCE  
IN DIFFERENT TYPES OF BUILDING**

**6.2.1.3 Cost performance of DP in residential house**

In a general way, it has the difference of peak load period between residential consumers and whole consumers which contained commercial and industry sectors. Due to time delay, it will cause a bad influence on residential consumers when using dynamic pricing at high load period. In order to get a clear conclusion, this part compared the electricity cost caused by using regular pricing and using dynamic price, take an analysis of the cost performance of DP.

As shown in figure.6-3, every month of all spending on electricity using dynamic price is higher than that using regular price. In July, August and September, the cost of using dynamic price is about 41% higher than that using regular price.

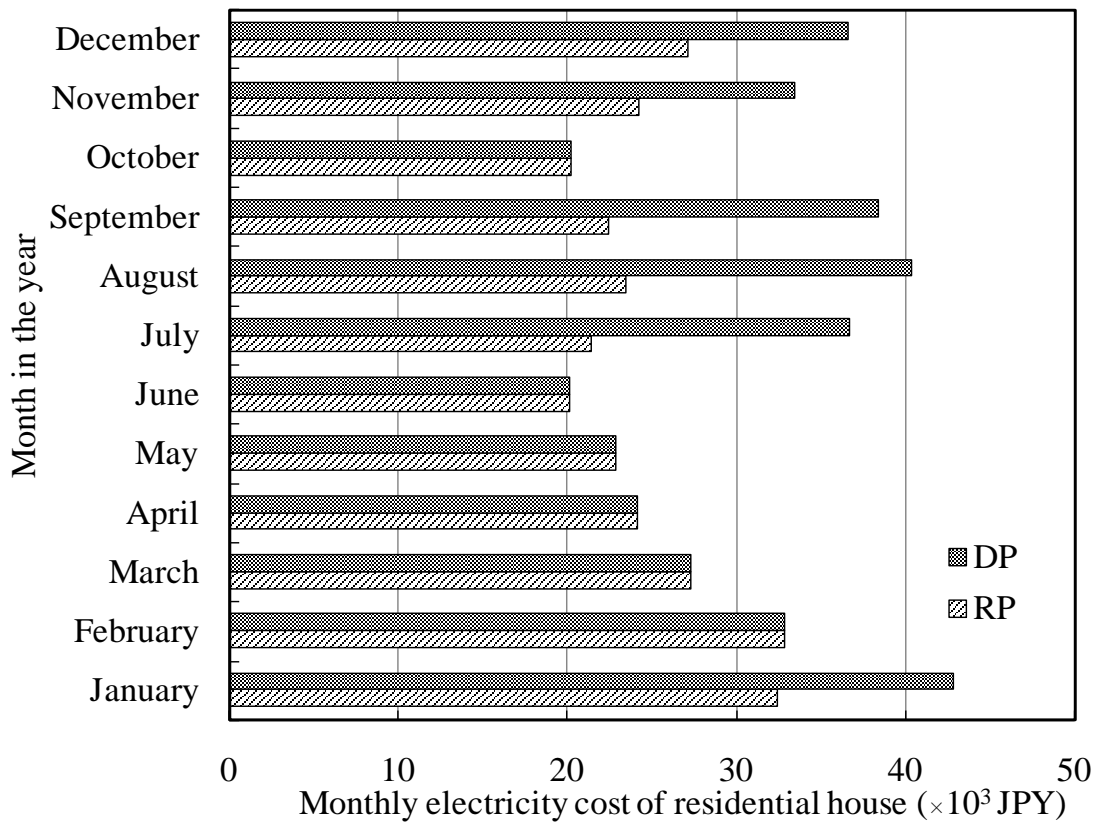

Figure 6-3 Monthly electricity cost comparison between RP and DP in a residential house



## CHAPTER SIX: ANALYSIS OF THE EFFECTS OF DYNAMIC PRICING AND ENERGY SAVING TECHNOLOGIES ON THE COST PERFORMANCE IN DIFFERENT TYPES OF BUILDING

### 6.2.2 The case of hospital

As for hospital, a hospital in Yahata Higashi area of Kitakyushu with floor area 20294.58 m<sup>2</sup> has been selected as case study.

#### 6.2.2.1 Electricity load of hospital

Figure 6-4 shows the electricity demand of hospital. As for hospital, the daily electricity load characteristics are tightly related to its working time and patients' hospitalizing time. We can clearly see from figure 6-4 that about 5:00, the electricity load reached at a small morning peak caused by patient rounds. After that, it starts to climb until reached at maximum load from 6:00 to 10:00, this is mainly because that many people prefer visiting hospital in morning which result in the use of medical equipment. In the period from 10:00 to 17:00, electricity load remains high because of the hospitalizing time. After 17:00, the load has fallen slightly. At night time, the load curve is also not a straight line, owing to the emergency treatment and some medical activities of inpatient.

#### 6.2.2.2 Electricity price of hospital

Table 6-2 shows the dynamic pricing system in hospital. In hospital, for RP, the price is 8JPY/kWh for 1am-7am and 22pm to 24pm, 12JPY/kWh for 8am to 13pm and 16pm to 22pm, 14JPY/kWh for 13pm to 16pm. For DP, the price is 6JPY/kWh for 1am-8am and 22pm to 24pm, 9JPY/kWh for 8am to 13pm and 16pm to 22pm, 10.5JPY/kWh for 16pm and 84JPY/kWh for 13pm to 15pm. According to Fig. 3-5, the price is of off-peak period is declined in the proportion of 25%. The peak period price from 1 pm to 3 pm of dynamic price is about 6 times higher than that of regular price.

Table 6-2 Electricity information of Hospital

(Source: Kyushu electricity)

		RP	DP
Basic charge (JPY/kW)		1848	1848
Volume charge (JPY/kWh)	Off peak (1:00-7:00; 22:00-24:00)	8	6
	Middle (8:00-12:00; 16:00-21:00)	12	9
	On peak (12:00-15:00)	14	84

**CHAPTER SIX: ANALYSIS OF THE EFFECTS OF DYNAMIC PRICING  
AND ENERGY SAVING TECHNOLOGIES ON THE COST PERFORMANCE  
IN DIFFERENT TYPES OF BUILDING**

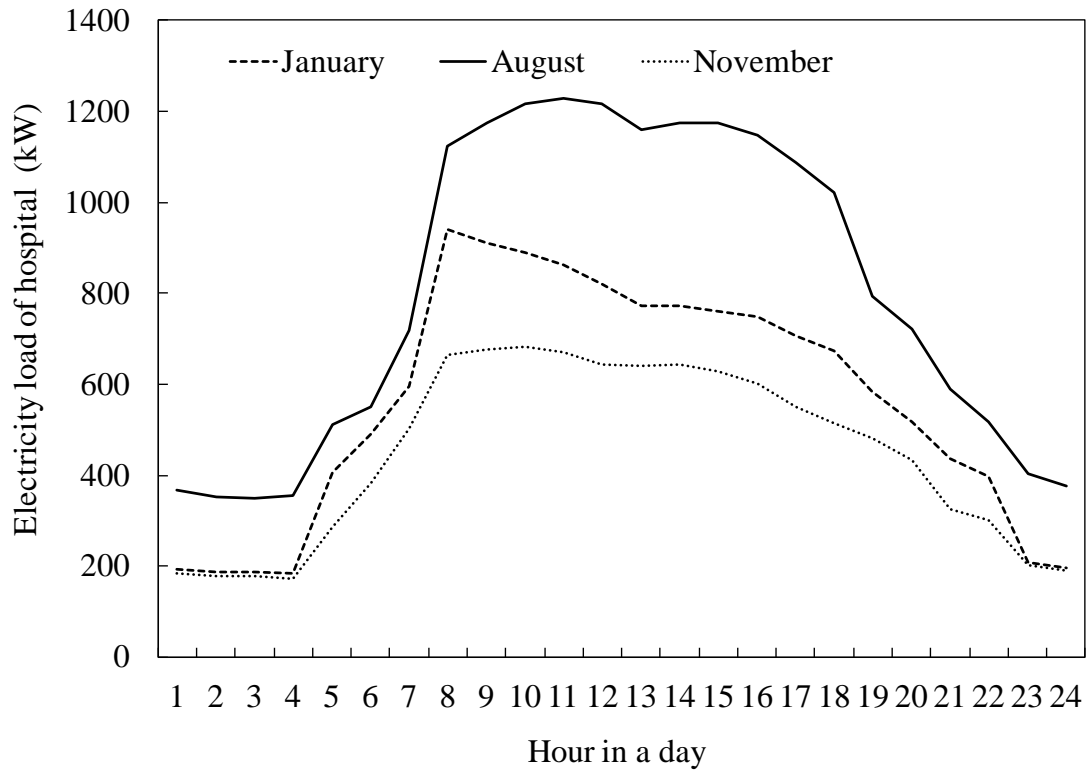

Figure 6-4 Hourly electricity load of Hospital

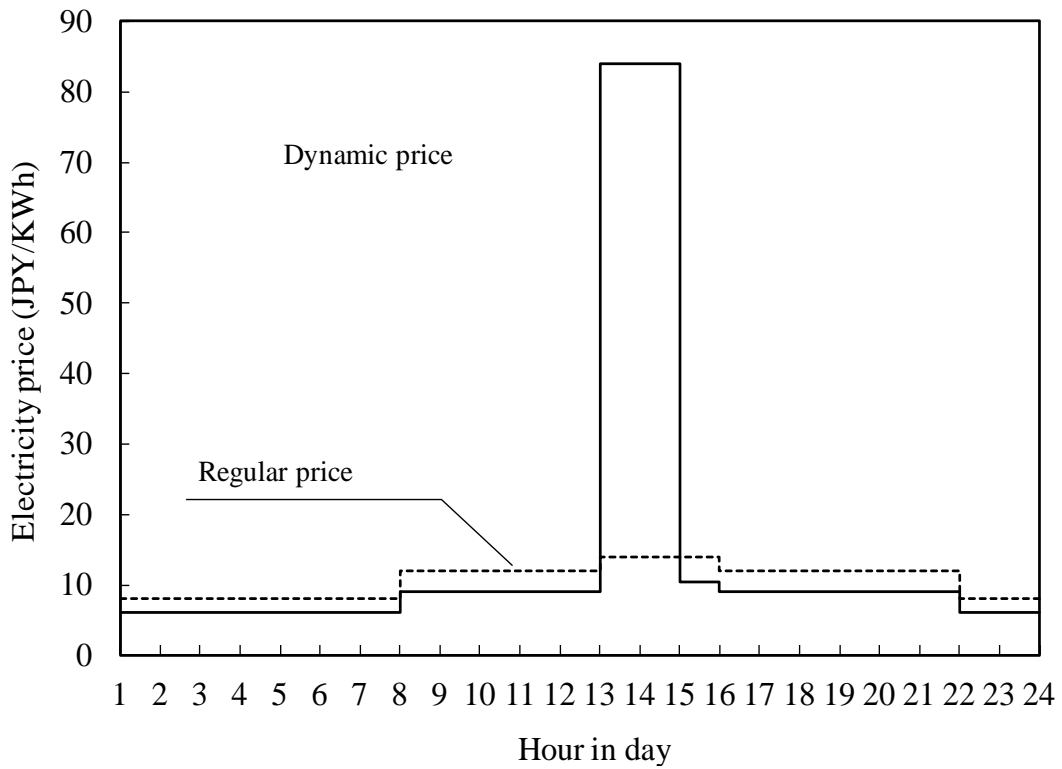

Figure 6-5 Electricity price of hospital

**CHAPTER SIX: ANALYSIS OF THE EFFECTS OF DYNAMIC PRICING  
AND ENERGY SAVING TECHNOLOGIES ON THE COST PERFORMANCE  
IN DIFFERENT TYPES OF BUILDING**

**6.2.2.3 Cost performance of DP in hospital**

Hospital has its special operating characteristics. Actually, in order to meet patients' hospitalizing time, it has to use electricity during some peak hours and it is not allowed that hospital shift electricity load consciously even it may cause some economic losses if they use dynamic price. Therefore the effect of using dynamic price on hospital side still needs to be investigated. Next, we compared the electricity cost of hospital with using regular pricing and dynamic price.

The monthly electricity cost of hospital can be calculated as illustrated in Eq. (6-2). Where,  $C_c$  denotes the contract capacity of hospital. Year electricity cost  $C_{Hos}$  is also composed of the monthly base cost and total variable electricity cost. As for hospital, the basic electricity charge is 1848 JPY per kW, volume charge was described in figure 6-5.

$$C_{Hos} = \sum_d \sum_h E_{d,h} P_h + \sum_m P_{base} \times C_c \quad (6-2)$$

After the calculation, the result was shown in figure 6-6. We can know that every month of all spending on electricity using dynamic price is higher than that using regular price. In August, the

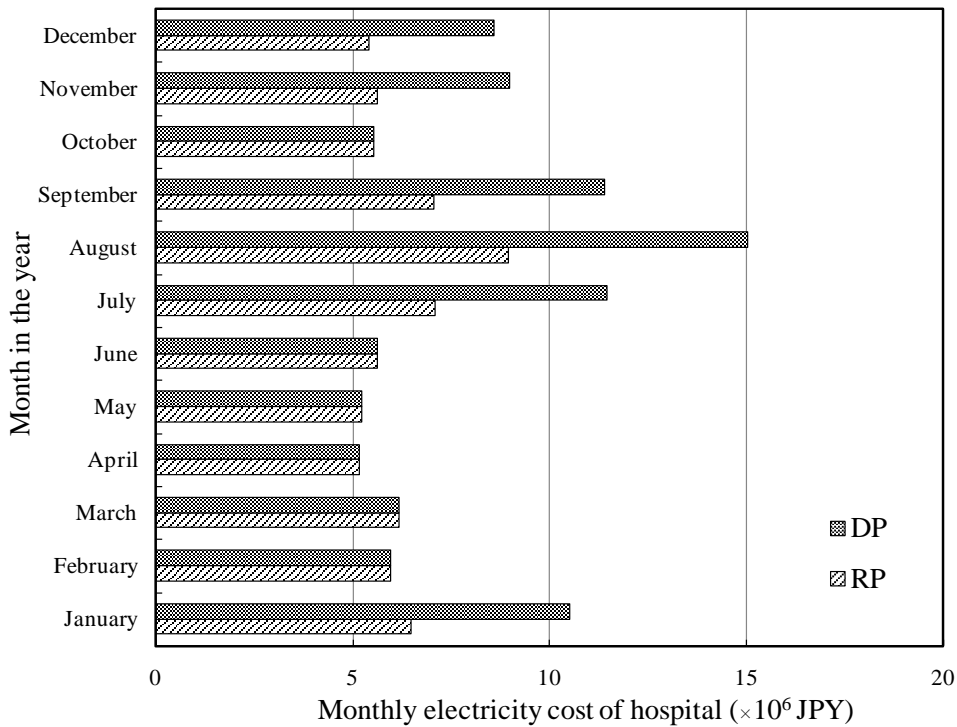

Figure 6-6 Monthly electricity cost comparison between RP and DP in a hospital

cost of using dynamic price is 40% higher than that of using regular price.

## CHAPTER SIX: ANALYSIS OF THE EFFECTS OF DYNAMIC PRICING AND ENERGY SAVING TECHNOLOGIES ON THE COST PERFORMANCE IN DIFFERENT TYPES OF BUILDING

### 6.2.3 The case of office

As for office case, an office with floor area 5000m<sup>2</sup> which located in kitakyushu city has been selected as case study.

#### 6.2.4.1 Electricity load of office

As figure 6-7 shown, the electricity load of office house in summer is much higher than the load in other periods. For the reason that office house usually have many office equipments which can't have good heat dissipation under the hot weather, this will aggravates the indoor temperature environment and lead to that more electricity was need to meet the increased cooling load. Figure 6-8 also shows us that the peak period of electricity usage for office house appears from 9:00 to 18:00 which is tightly related to the working hour of offices. In the night, office house almost have no electricity consumption.

#### 6.2.4.2 Electricity price of office

As table 6-3 shows, in office, for RP, the price is 20JPY/kWh for the whole day. For DP the price is 120JPY/kWh for 13:00 to 15:00 and 15JPY/kWh for other periods. According to the Fig. 6-9, we can know that compared with regular price, dynamic price in the period of 1:00-13:00, 15:00-24:00, is declined in the proportion of 25%. The peak period price from 12:00 to 15:00 of DP is about 6 times higher than the RP.

#### 6.2.4.3 Cost performance of DP in office

In order to ensure the normal working habits of offices, we assume that the electricity load of office side in peak period remains unchanged. With the same calculation method as shown in Eq. (2), the cost performance of DP was shown in figure 6-10. Every month of all spending on electricity using dynamic price is higher than that using regular price. In August, the cost of using dynamic price is about 51% higher than that of using regular price.

Table 6-3 Electricity information of Office

(Source: Kyushu electricity)

		RP	DP
Basic charge (JPY/kW)		1090	1090
Volume charge (JPY/kWh)	Off peak (other period times)	20	15
	On peak (12:00-15:00)	20	120

**CHAPTER SIX: ANALYSIS OF THE EFFECTS OF DYNAMIC PRICING  
AND ENERGY SAVING TECHNOLOGIES ON THE COST PERFORMANCE  
IN DIFFERENT TYPES OF BUILDING**

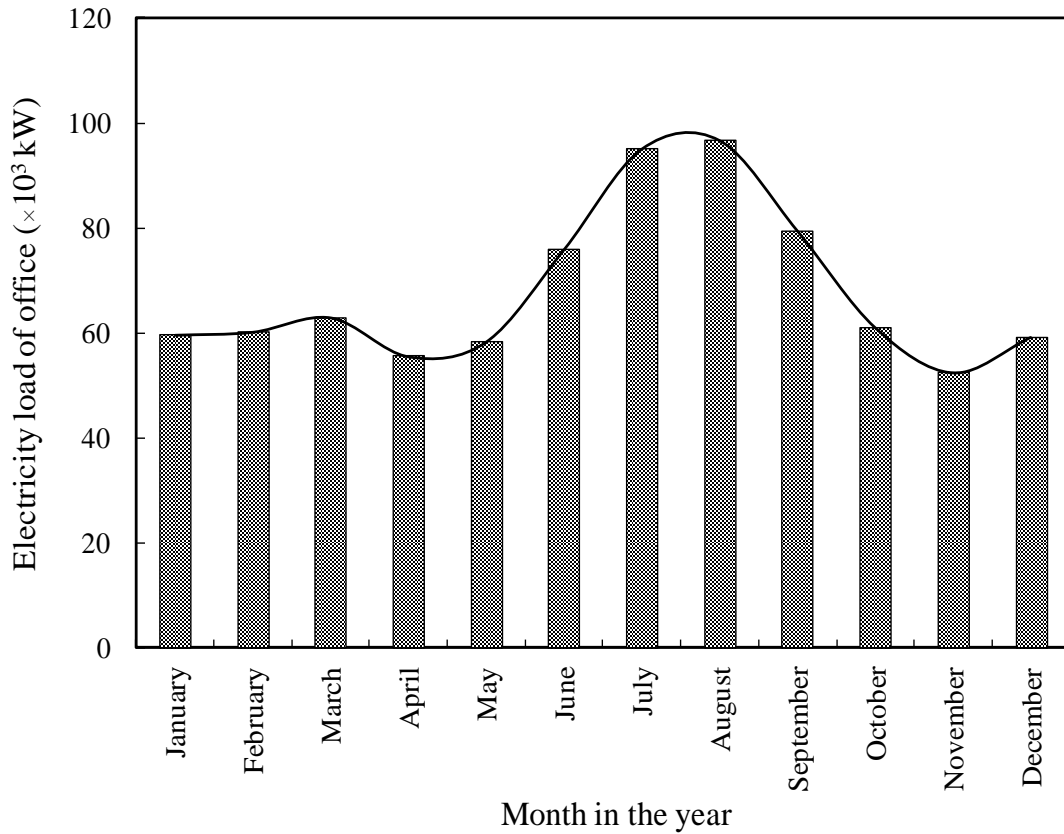

Figure 6-7 Monthly electricity load of office house

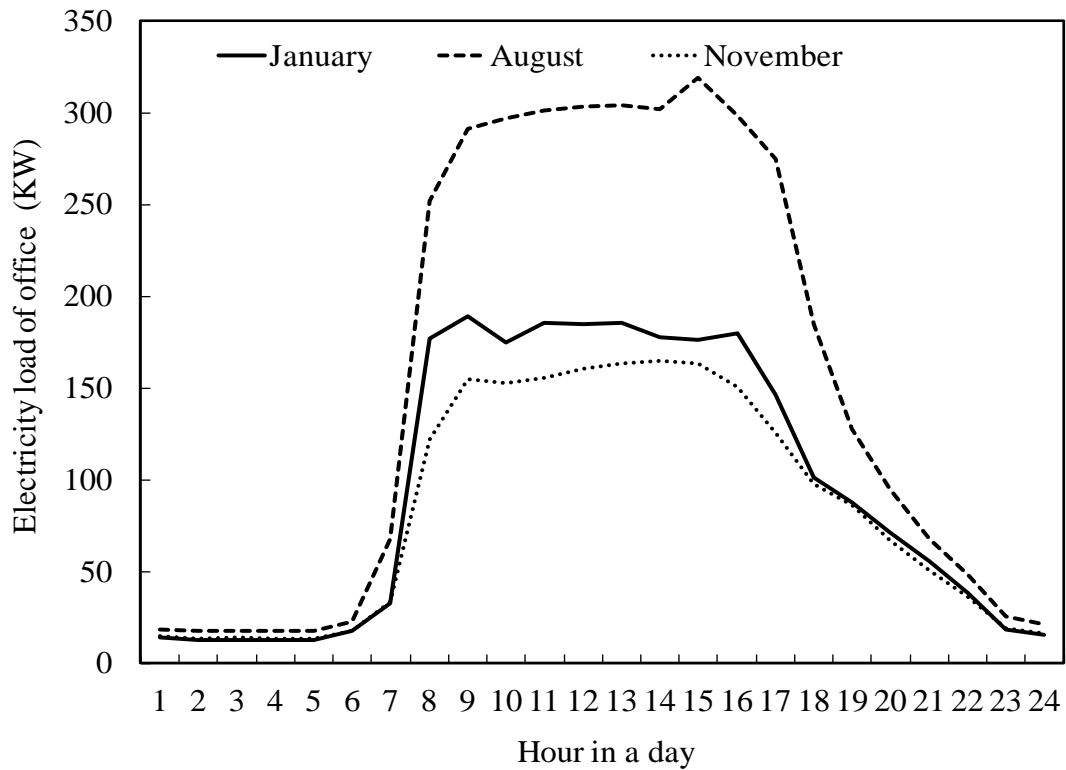

Figure 6-8 Hourly electricity load of office house

**CHAPTER SIX: ANALYSIS OF THE EFFECTS OF DYNAMIC PRICING  
AND ENERGY SAVING TECHNOLOGIES ON THE COST PERFORMANCE  
IN DIFFERENT TYPES OF BUILDING**

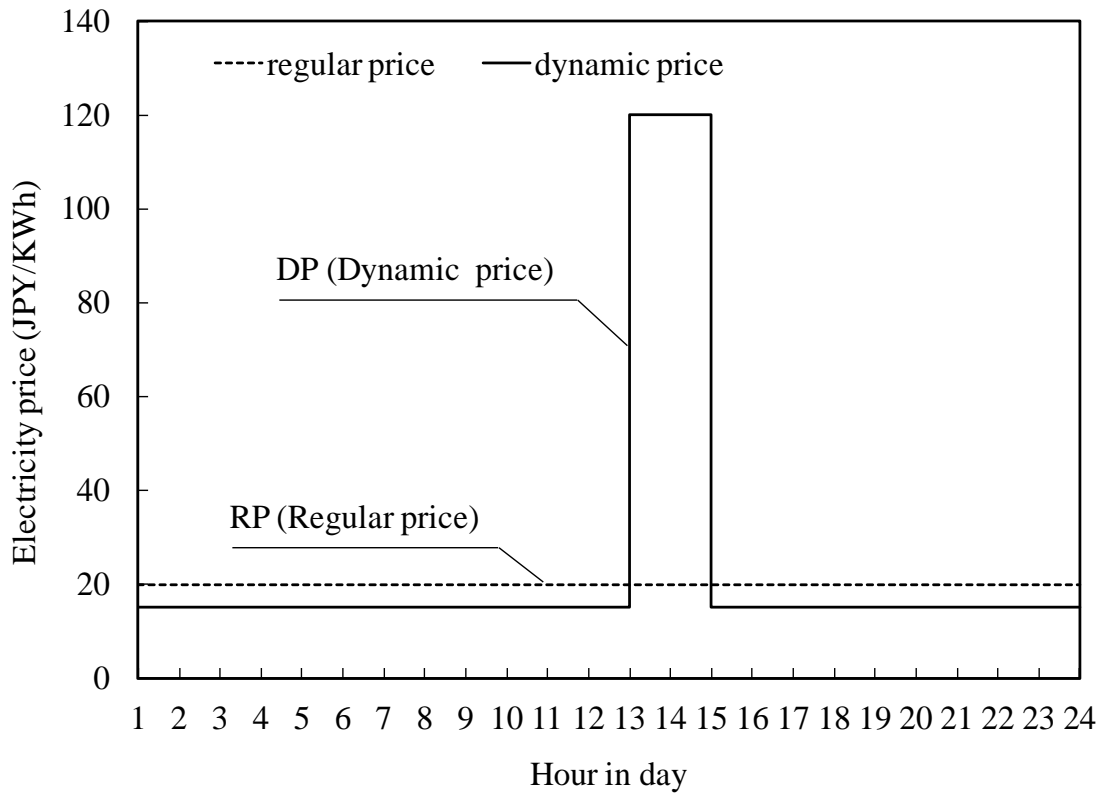

Figure 6-9 Electricity price of office

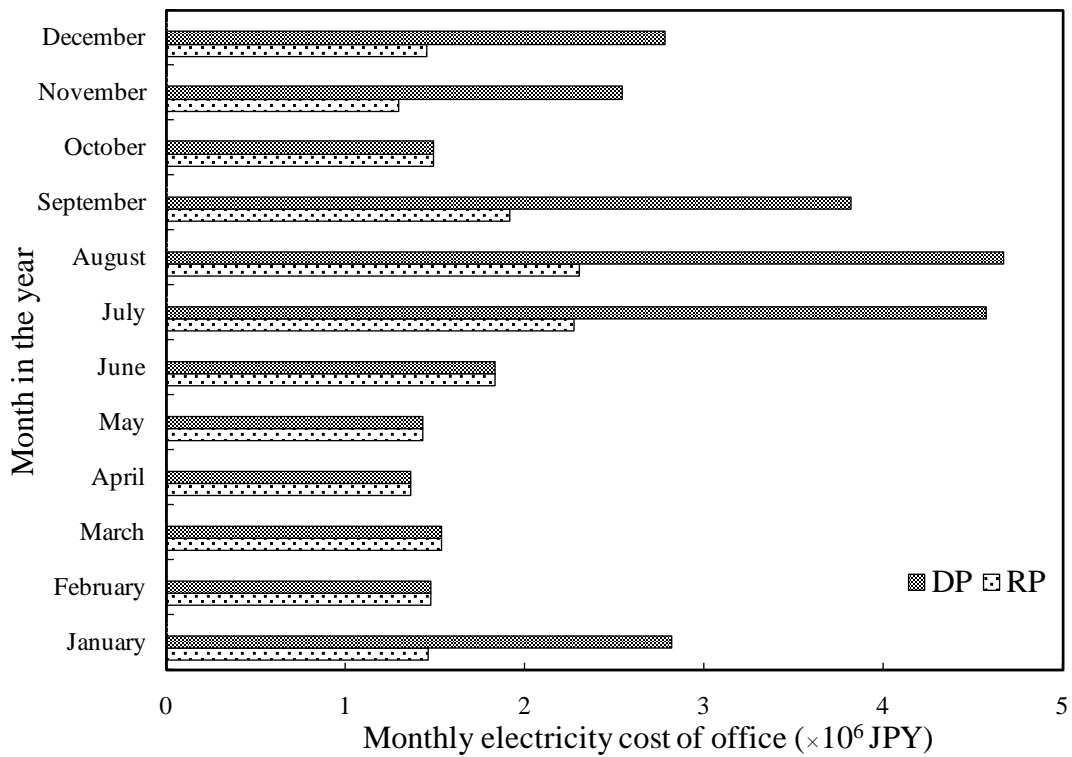

Figure 6-10 Monthly electricity cost comparison between RP and DP in an office

## CHAPTER SIX: ANALYSIS OF THE EFFECTS OF DYNAMIC PRICING AND ENERGY SAVING TECHNOLOGIES ON THE COST PERFORMANCE IN DIFFERENT TYPES OF BUILDING

### 6.2.4 The case of hotel

As for the case of hotel, we choose the hotel which located in Yahata Higashi of Kitakyushu with floor area 20054 m<sup>2</sup> as target building.

#### 6.2.4.1 Electricity load of hotel

As for hotel, in august, we can clearly see from figure 6-11 that about 6am, the electricity load starts to rise slowly, owing to the daily activities of hotel in the morning. After that, it continues to climb until reached at maximum load at 3pm, this is mainly because that cooling load was increased with the high temperature of summer. In the period from 7pm to 5am, electricity load began to fall slowly, and in the night, it also has the electricity consumption.

#### 6.2.4.2 Electricity price of hotel

The electricity price which be used in hotel is as same as hospital. The DP in peak period is also the 6 times higher than that of RP. We can know the detailed information of electricity price of hotel from table 6-2 and figure 6-5.

#### 6.2.4.3 Cost performance of DP in hotel

Cause the electricity load and electricity price data of hotel is similar to the hospital. So the cost performance of DP in hotel is almost as same as hospital. According to the Eq. (6-2) and figure 6-5, we got the monthly electricity cost of hotel. It can be seen from figure 6-12 that if hotel do not respond to DP, the cost of using DP is higher than RP. In August, the cost of using DP is about 40% higher than that of using RP.

**CHAPTER SIX: ANALYSIS OF THE EFFECTS OF DYNAMIC PRICING  
AND ENERGY SAVING TECHNOLOGIES ON THE COST PERFORMANCE  
IN DIFFERENT TYPES OF BUILDING**

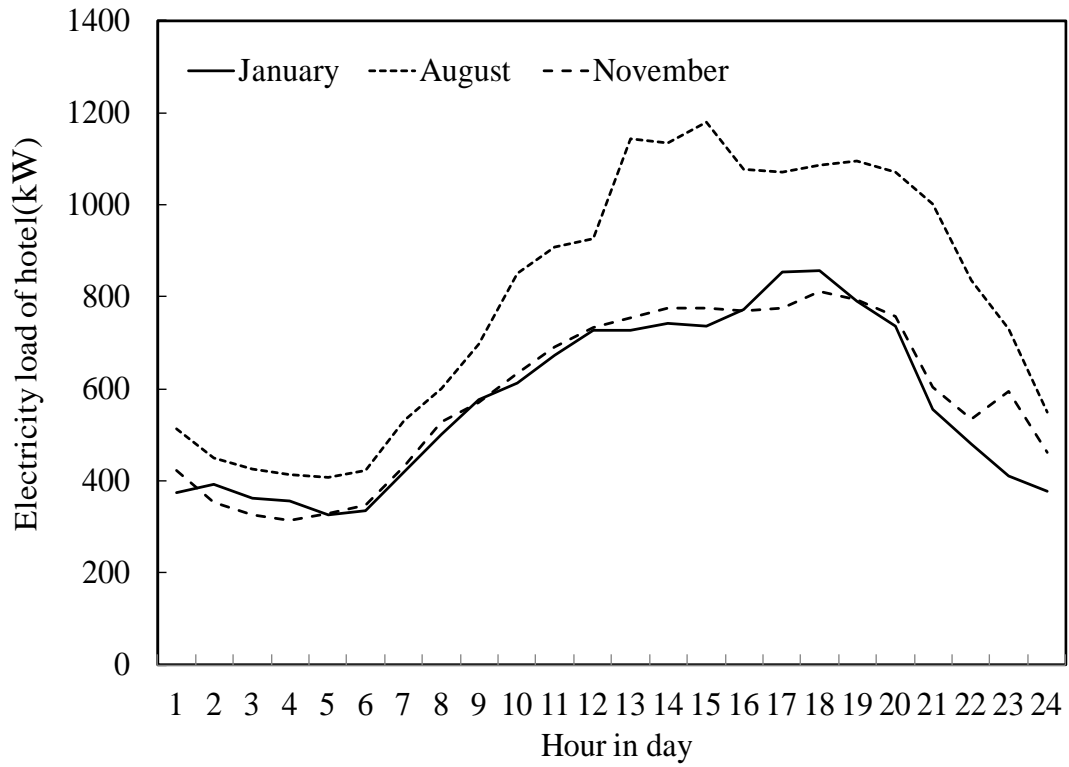

Figure 6-11 Hourly electricity load of hotel

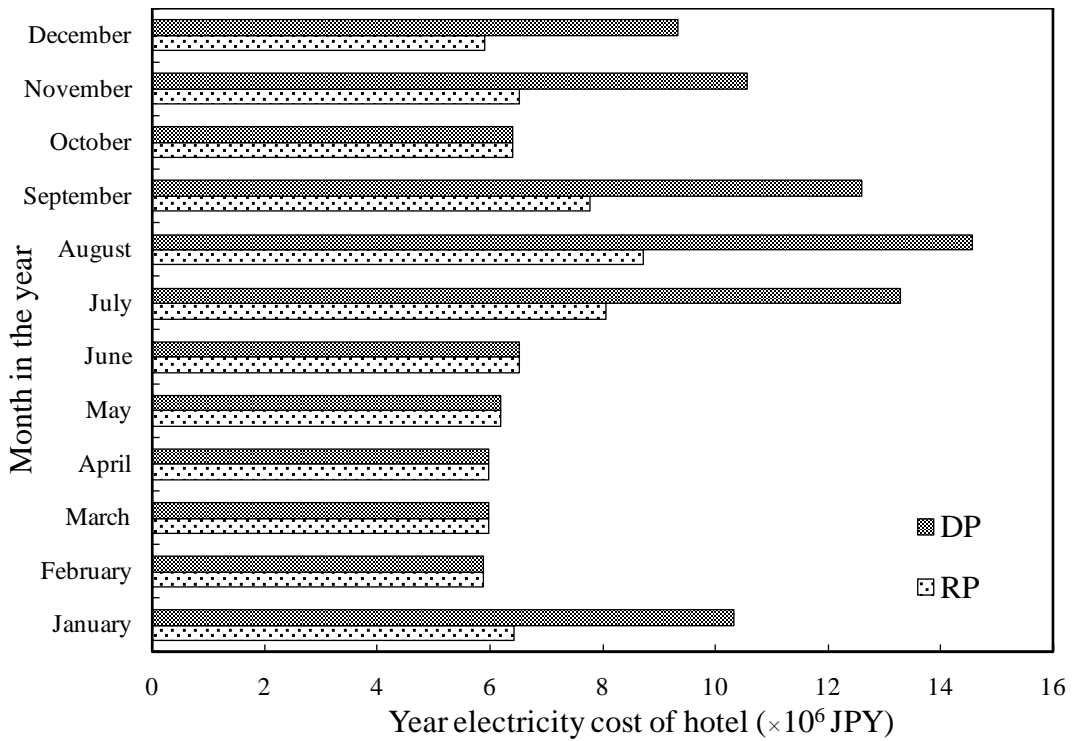

Figure 6-12 Monthly electricity cost comparison between RP and DP in hotel



## CHAPTER SIX: ANALYSIS OF THE EFFECTS OF DYNAMIC PRICING AND ENERGY SAVING TECHNOLOGIES ON THE COST PERFORMANCE IN DIFFERENT TYPES OF BUILDING

### 6.3 Effects of DP on the Cost Performance of Buildings in DR Scenario

As for this part, the tiny demand response activity for buildings which we selected is some common energy saving activities that would not affect consumers' daily life and working schedule seriously.

Figure 6-13 shows the load features of electricity consumption in different buildings on one typical day. Curve 1 is the electricity consumption of hotel, curve 2 is the electricity consumption of hospital and curve 3 is the electricity consumption of residents. The top curve is the total electricity consumption of all kinds of consumers.

Generally, in order to satisfy the peak power demands, new power generation and distribution equipment were needed to build and deploy which results in expenditure on related cost (initial investment, etc). In addition, the difference between peak electricity load and off-peak electricity load also resulted in lower operation efficiency of associated equipment. For these reason, it is essential to take actions to make electricity leveling.

According to this figure, we can know that the period from 8 am to 8 pm is the time zone that we need to do the electricity saving, and there is a tendency that the consumption peak will appears in the period from 1 pm to 3 pm. Therefore, try to do the power-saving of this time zone is

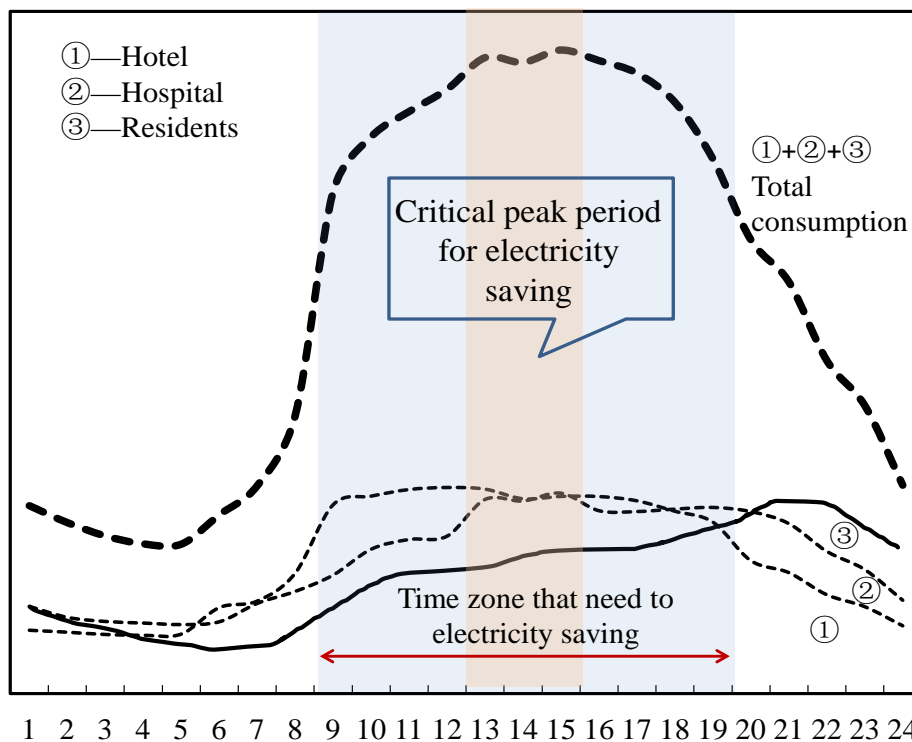

Figure 6-13 Features of electricity consumption of different buildings in one day

(Source: Agency for natural resources and energy)

## CHAPTER SIX: ANALYSIS OF THE EFFECTS OF DYNAMIC PRICING AND ENERGY SAVING TECHNOLOGIES ON THE COST PERFORMANCE IN DIFFERENT TYPES OF BUILDING

particularly important.

### 6.3.1 The case of residential house

Electricity consumption is an important part of energy use in a residential house, it is closely related to our daily lives. Figure 6-14 is the household electricity consumption by end use, it is obvious that air conditioning represents a significant proportion of the total electricity consumption of households, accounts for 58%. And owing to the issues of global warming, air conditioning will become a major contributor to summer peak demand in next few years. Therefore, the electricity saving methods which aimed to reducing cooling load is worth us to explore.

In addition, the electricity usage of refrigerator in residential house have also accounted for a large proportion, reached to 17%. Next, it followed by lighting (6%), television (5%) and standby power (3%). See from the proportion distribution, it is better for residents to take energy-saving actions from three aspects, air-conditioning, refrigerator and lighting.

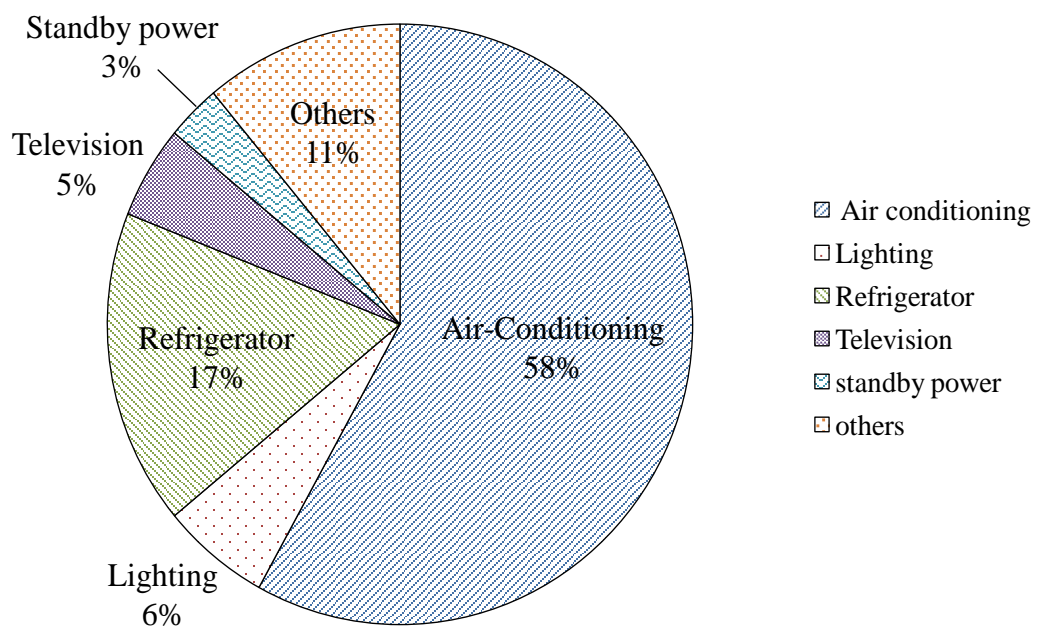

Figure 6-14 Household electricity consumption by end use

(Source: Agency for natural resources and energy)

**CHAPTER SIX: ANALYSIS OF THE EFFECTS OF DYNAMIC PRICING  
AND ENERGY SAVING TECHNOLOGIES ON THE COST PERFORMANCE  
IN DIFFERENT TYPES OF BUILDING**

**6.3.1.1 Introduction of energy saving actions in residential house**

Saving electricity in residential house has become increasingly important in recent years. Using electricity without considering energy conservation contributes to global warming and massive electricity bills. Therefore, using appliances reasonably and forming healthy energy consumption habits can help residents save energy charge if dynamic price was be widespread promoted in an area.

Table 6-4 is the common electricity saving actions in residential house. It provides seven methods for our reference. For example, set the indoor temperature 2°C higher and turn off unnecessary lighting during the day time.

Table 6-4 Common electricity saving actions in residential house

Electricity saving actions in residential house	
Air-conditioning side	(1) Set the room temperature 2°C higher, reached to 28°C
	(2) Turn off the air-conditioning within reason, use the fan
	(3) All residents try to use air-conditioning in one room
Lighting side	(4) Turn off unnecessary lighting during the day time
	(5) Change the traditional lighting to LED lighting
Basic habit side	(6) Turn off the main power source rather than the power of remote control
	(7) Set the refrigerator operation from high to medium, decrease the time to open the door as much as possible

Firstly, we introduced the electricity saving methods from air-conditioning side.

Figure 6-15 is the average temperature of kitakyushu Yahata in August. According to this figure, we can know that the temperature from 13:00 to 15:00 is higher than other time period. In addition, the electricity price of this period is also high. In order to maintain residents' living comfort, consumers must use air-conditioning in this time zone. Therefore, two electricity saving ways that related to air-conditioning side have been put forward.

Detailed information of these two methods can be seen in table 6-5. We can know that in period from 13:00 to 15:00, method 1 is setting indoor temperature 2°C higher while using air-conditioning; Method 2 is that all residents try to use AC in one room. Owing to the temperature from 19:00 to 21:00 is not so high, both of two methods are use fan to instead of AC from this period.

Table 6-5 Electricity saving methods from air-conditioning side

	13:00-15:00	19:00-21:00
Method 1	Use air-conditioning, meanwhile set the room temperature 2°C higher	turn off the air-conditioning within reason, use the fan
Method 2	All residents try to use air-conditioning in one room	

**CHAPTER SIX: ANALYSIS OF THE EFFECTS OF DYNAMIC PRICING  
AND ENERGY SAVING TECHNOLOGIES ON THE COST PERFORMANCE  
IN DIFFERENT TYPES OF BUILDING**

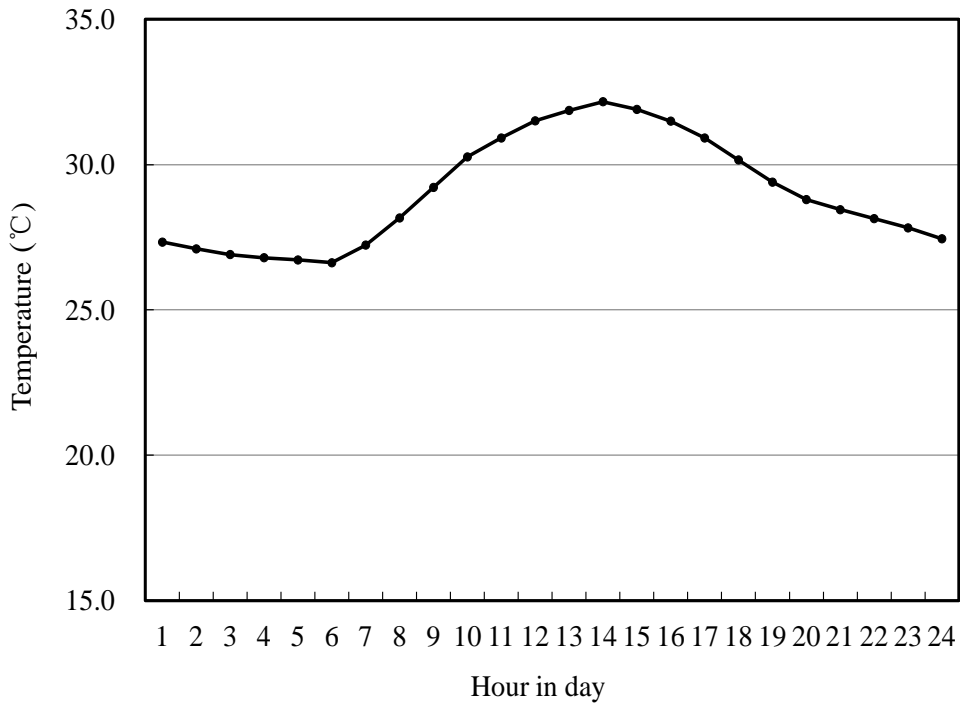

Figure 6-15 Average temperature of Kitakyushu Yahata in August

(Source: Japan Meteorological Agency)

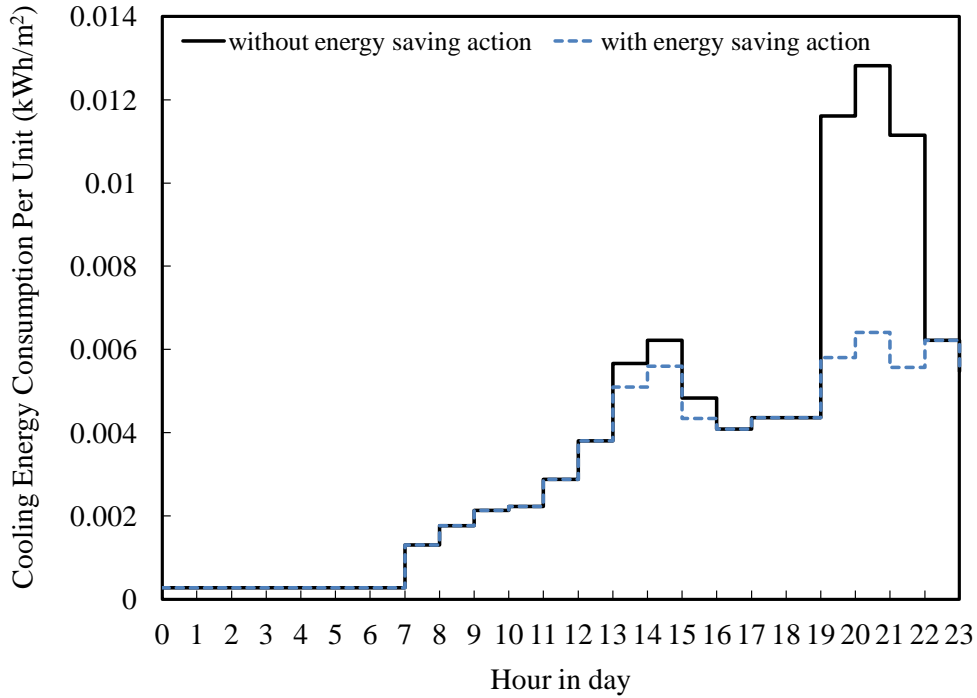

Figure 6-16 Load profile of electricity saving method from air-conditioning side in residential house (method 1)

(Source: Agency for natural resources and energy)

**CHAPTER SIX: ANALYSIS OF THE EFFECTS OF DYNAMIC PRICING  
AND ENERGY SAVING TECHNOLOGIES ON THE COST PERFORMANCE  
IN DIFFERENT TYPES OF BUILDING**

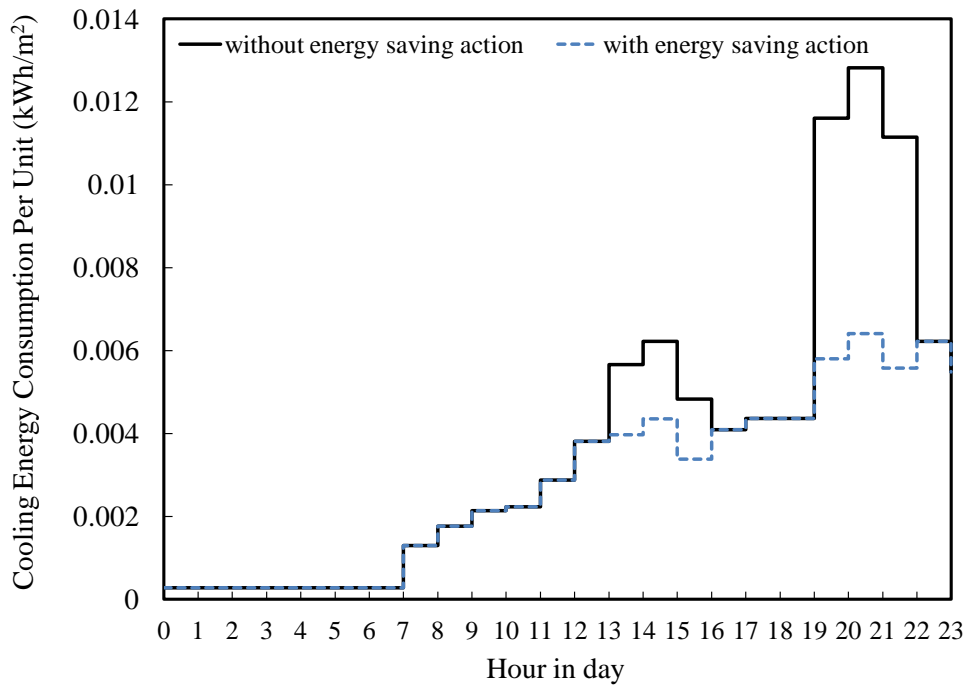

Figure 6-17 Load profile of electricity saving method from air-conditioning side in residential house (method 2)

(Source: Agency for natural resources and energy)

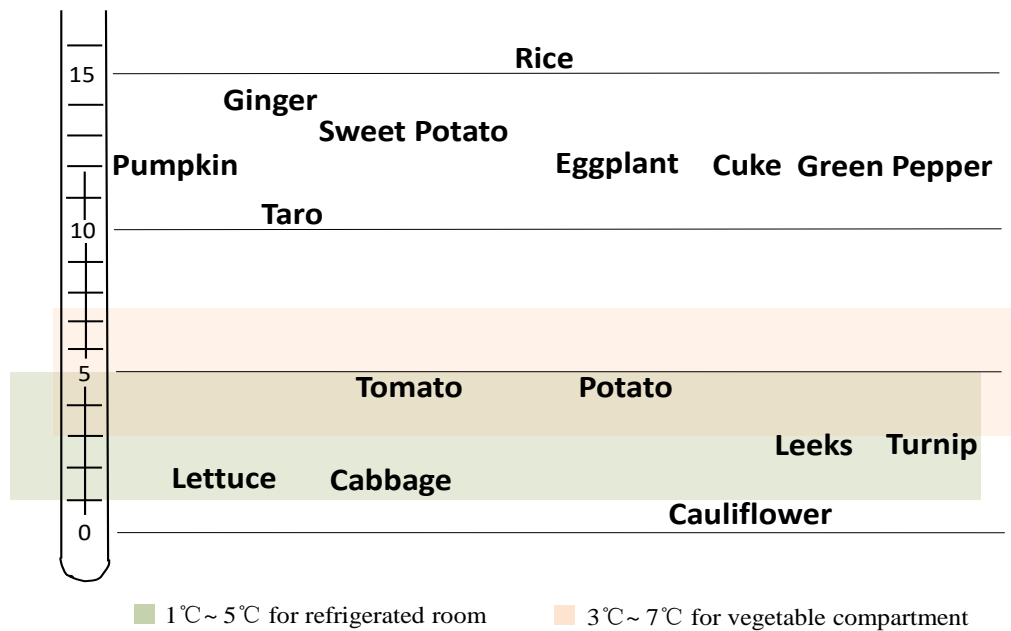

Figure 6-18 Proper storage temperature of different foods

## CHAPTER SIX: ANALYSIS OF THE EFFECTS OF DYNAMIC PRICING AND ENERGY SAVING TECHNOLOGIES ON THE COST PERFORMANCE IN DIFFERENT TYPES OF BUILDING

Figure 6-16 and 6-17 are the cooling load profiles of two electricity saving methods from air-conditioning side that referred above. Take the data of agency for natural resources and energy as reference, we can know that if we set our indoor temperature 2°C higher while using air-conditioning from 13:00 to 15:00 period, 10% electricity using can be saved. Meanwhile, if all residents use air-conditioning in one room at that period, 30% electricity using can be saved. In addition, from 19:00 to 21:00, using fan to instead of air-conditioning can get 50% electricity saving effect.

Secondly, the electricity saving methods from lighting and basic habits side will be introduced. In this part, we combined basic habits with light using, attempt to achieve maximum energy saving effects. As for the basic habits of residents, refrigerator is an indispensable appliance and be used every day in normal daily life. As for most households, refrigerator is the second-largest user of electricity, right after the air conditioner. People can save energy by using some appliances less, but it is not suitable for refrigerator. The main way we can take effort to realize energy saving is to use refrigerator under an efficient stage. As for this part, the recommended method is that setting the refrigerator operation mode from high to medium, decrease the time of opening the door as much as possible. Arranging food in appropriate temperature can realize the reduction of energy use by as much as 20-25%.

Figure 6-18 is the proper storage temperature of different foods.

As for the electricity saving methods related to lighting, two ways were provided for the consumers. One is turning off unnecessary lighting during the day time. Another one is converting the traditional lighting to LED lighting. Generally, LED use at least 75 percent less energy and last up to 50 times longer than traditional incandescent light bulbs. Two distinct advantages of LEDs are their lifetime and increased efficiency. Table 6-6 is the comparison between three different kinds of lights, we can see that even the lumens cost of LED is almost three times of traditional light, its lifetime and efficiency are much higher than others'.

Table 6-6 Comparison between three different kinds of lights

	Incand	Fluorescent	LED		
			2003	2007	2012
Efficiency(LPW)	16	85	25	75	150
Flux(lm/lamp)	1200	3400	30	200	1000
Lumens Cost(\$/klm)	0.4	1.5	200	20	4.5
Lifetime(khr)	1	10	50	75	100

Take the combination of basic habits and light use, there are also two electricity saving methods were suggested which as shown in table 6-7.

Table 6-7 Electricity saving methods from basic habits and lighting side

	6:00-19:00	Other Period
Method 3	turn off unnecessary lighting during the day time	turn off the main power source rather than the power of remote control
Method 4	change the traditional lighting to LED lighting; setting the refrigerator from high to medium, decrease the time of opening the door as much as possible	

**CHAPTER SIX: ANALYSIS OF THE EFFECTS OF DYNAMIC PRICING  
AND ENERGY SAVING TECHNOLOGIES ON THE COST PERFORMANCE  
IN DIFFERENT TYPES OF BUILDING**

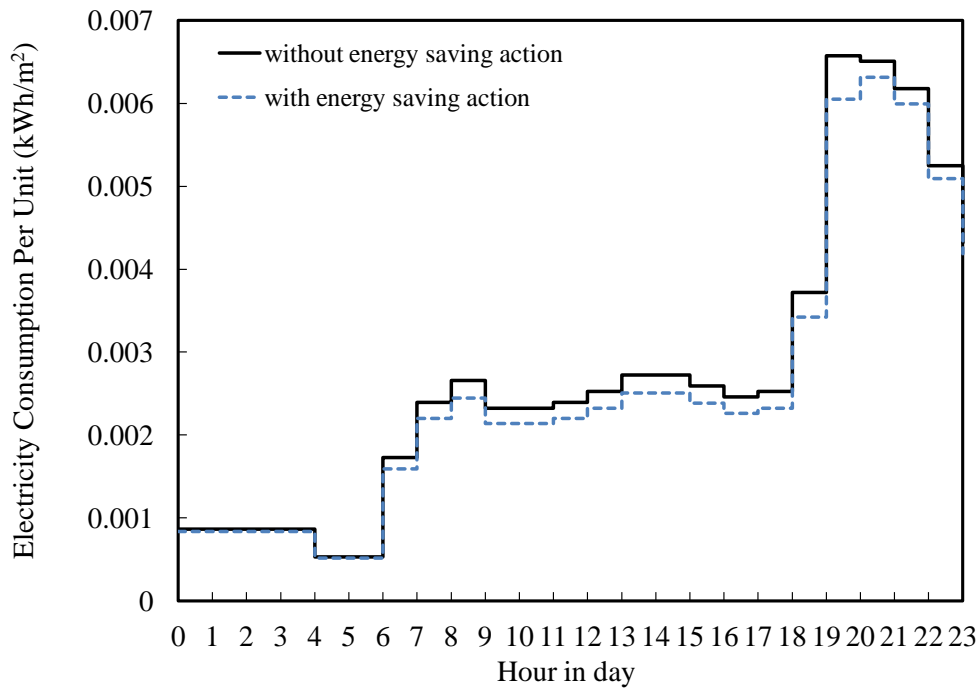

Figure 6-19 Load profile of electricity saving method from lighting side  
in residential house (method 3)

(Source: Agency for natural resources and energy)

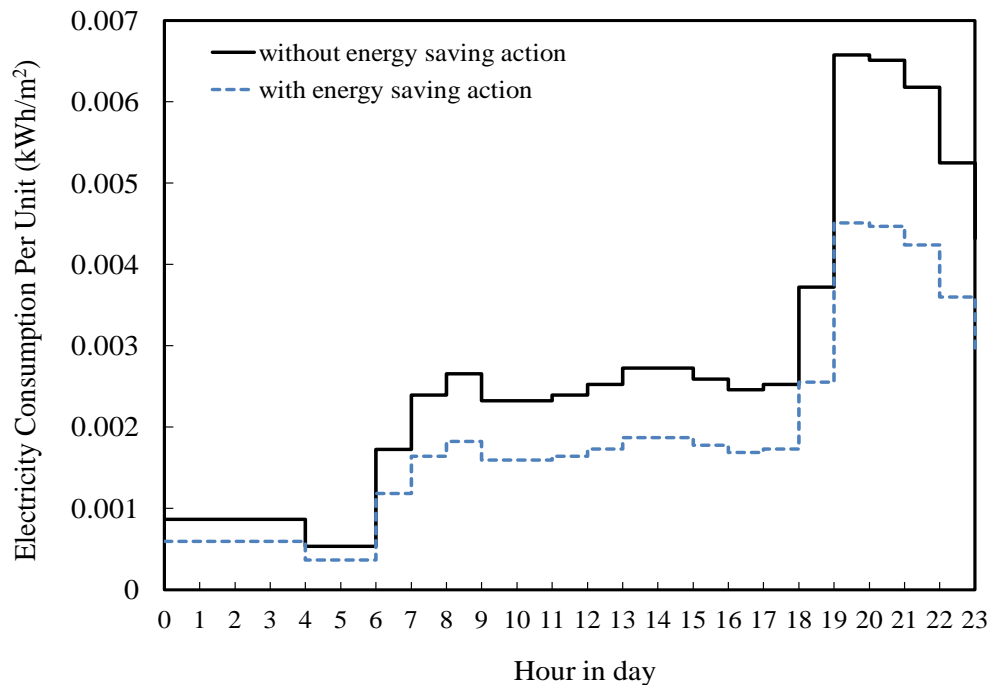

Figure 6-20 Load profile of electricity saving method from lighting side  
in residential house (method 4)

(Source: Agency for natural resources and energy)

**CHAPTER SIX: ANALYSIS OF THE EFFECTS OF DYNAMIC PRICING  
AND ENERGY SAVING TECHNOLOGIES ON THE COST PERFORMANCE  
IN DIFFERENT TYPES OF BUILDING**

Figure 6-19 and 6-20 are the electricity load profiles of two electricity saving methods which from basic habit and lighting side, respectively. According to the data of agency for natural resources and energy, we can get that turning off unnecessary lighting during the day time can realize 5% electricity saving; turning off the main power source can realize 3% electricity saving; changing the traditional lighting to LED lighting can realize 30% electricity saving and setting the refrigerator from high to medium, decreasing the time of opening the door as much as possible can realize 2% electricity saving.

**6.3.1.2 Electricity cost reduction effect of different actions**

Figure 6-21 is the year cost reduction effect of different electricity saving methods. It is obvious that method 2 that all residents try to use air-conditioning in one room is the most effective method, followed by method 1, method 4 and method 3.

The reason why method 1 and method 2 have better cost reduction effect is that air-conditioning takes the high proportion of total electricity usage in residential house. For the same reason, even method 3 and method 4 can reach a better energy saving in the aspect of refrigerator and lighting, but these two sections only take a small part of total electricity usage, so the cost reduction effect of these two methods is not obvious.

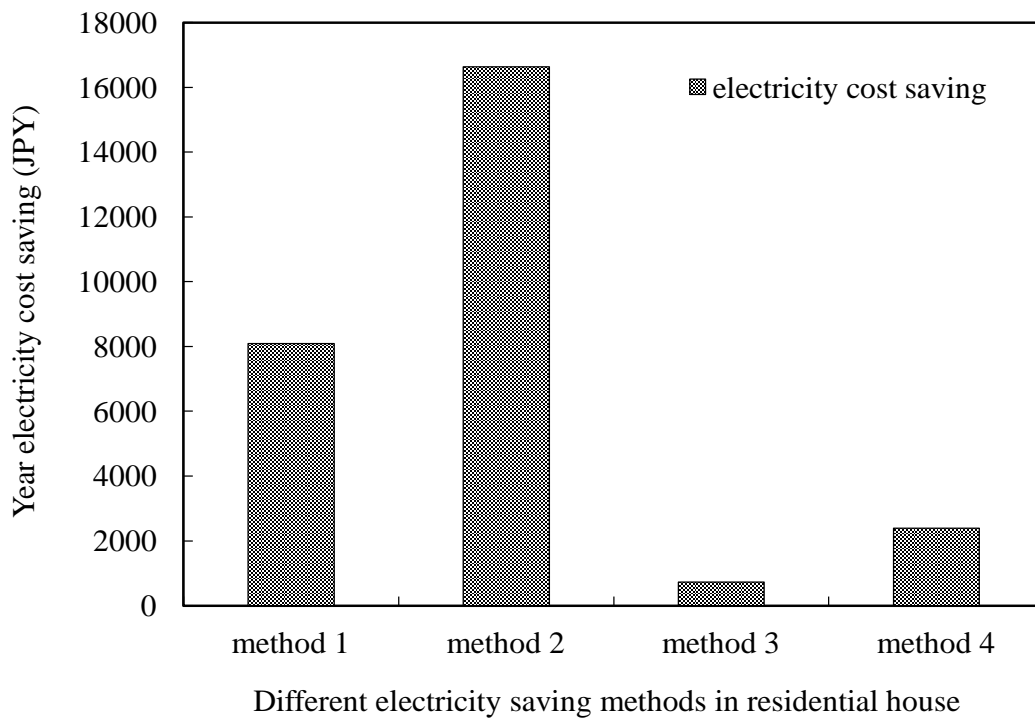

Figure 6-21 Year cost reduction effect of different electricity saving methods in residential house



**CHAPTER SIX: ANALYSIS OF THE EFFECTS OF DYNAMIC PRICING  
AND ENERGY SAVING TECHNOLOGIES ON THE COST PERFORMANCE  
IN DIFFERENT TYPES OF BUILDING**

**6.3.2 The case of hospital**

Figure 6-22 is the hospital electricity consumption by end use. It can be seen that air conditioning and lighting represent a significant share of the total electricity consumption, air conditioning accounts for about 38% and lighting accounts for about 37%. These two sections accounts for almost 75% of hospital’s total electricity consumption. Therefore, taking electricity saving measures in these two areas is particularly effective.

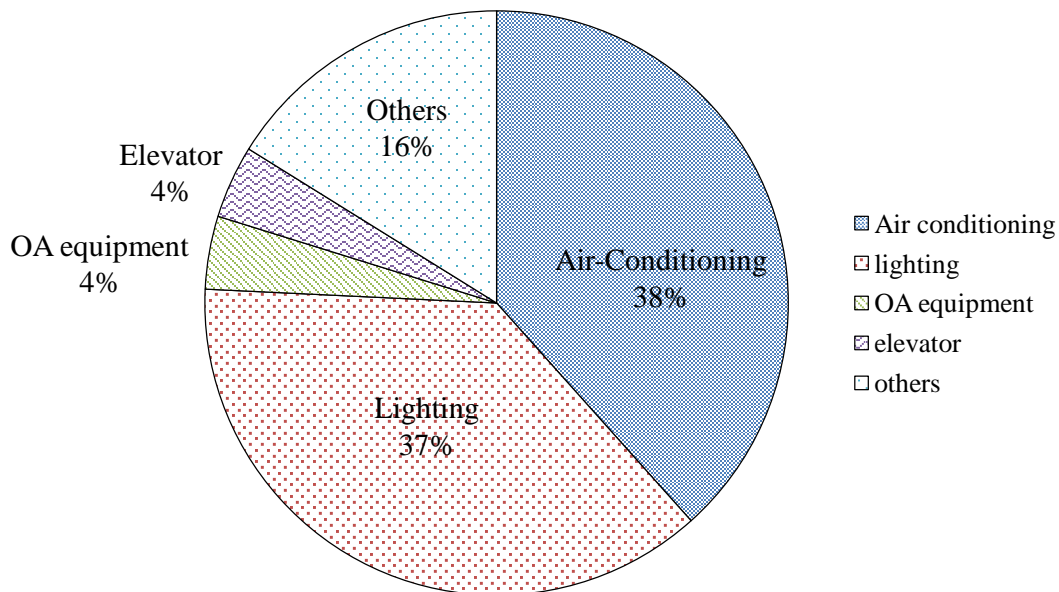

Figure 6-22 Electricity consumptions by end use in hospital

(Source: Agency for natural resources and energy)

**6.3.2.1 Introduction of energy saving actions in hospital**

Hospital buildings have large energy consumptions when compared to other offices. The energy consumption sectors that have been selected to take energy saving action for hospital are air-conditioning and lighting which hold on larger proportion. The content of detailed energy saving actions from these two sectors can be introduced as follows.

Table 6-8 is the common electricity saving actions in hospital from air-conditioning and lighting side. It provides seven ways for our reference. Like cleaning the filter of air conditioning regularly and taking advantage of thermal insulation.

According to the electricity saving actions that referred in table 6-8, three detailed methods were suggested to hospital consumers as table 6-9 shown.

Table 6-8 Common electricity saving actions in hospital

Electricity saving actions in hospital	
Air-conditioning side	(1) Thermal insulation improvement (take advantage of thermal barrier film) (2) Turn off AC in the area that is not used

**CHAPTER SIX: ANALYSIS OF THE EFFECTS OF DYNAMIC PRICING  
AND ENERGY SAVING TECHNOLOGIES ON THE COST PERFORMANCE  
IN DIFFERENT TYPES OF BUILDING**

- (before/ after the consolation hours of outpatient department)
- (3) Clean the filter of air conditioning regularly
  - (4) Water spray to the outdoor unit of air conditioning
- Lighting side
- (5) Turn off the lights in the area that is not used  
(before/ after the consolation hours of outpatient department)
  - (6) Decrease the lighting of office in hospital to 50%  
(On-call room; Release of information department; Hospital warehouse, etc)
  - (7) Change the traditional lighting to LED lighting

Table 6-9 Three electricity saving methods in hospital

	8:00-20:00	Other period
Method 1	Change the traditional lighting to LED lighting <sup>(7)</sup>	
Method 2	Turn off the lights in the area that is not used <sup>(5)</sup> ; decrease the lighting of office to 50% <sup>(6)</sup>	
Method 3	Thermal insulation improvement <sup>(1)</sup> ; Water spray to the outdoor unit of air conditioning <sup>(4)</sup>	Turn off AC in the area that is not used <sup>(2)</sup>

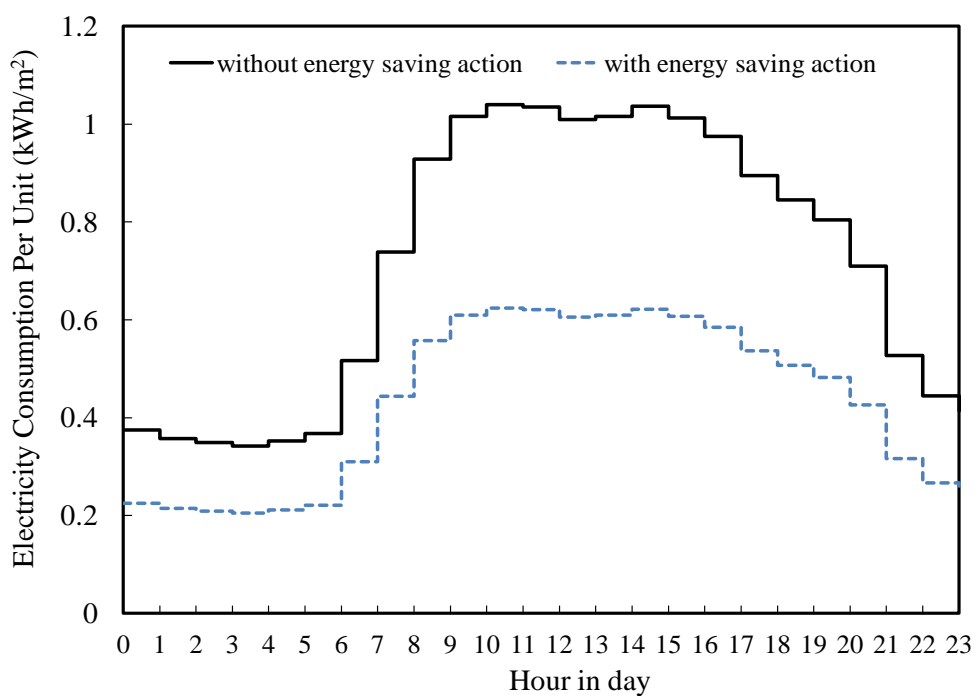

Figure 6-23 Load profile of electricity saving method from lighting side in hospital (method 1)

(Source: Agency for natural resources and energy)

**CHAPTER SIX: ANALYSIS OF THE EFFECTS OF DYNAMIC PRICING  
AND ENERGY SAVING TECHNOLOGIES ON THE COST PERFORMANCE  
IN DIFFERENT TYPES OF BUILDING**

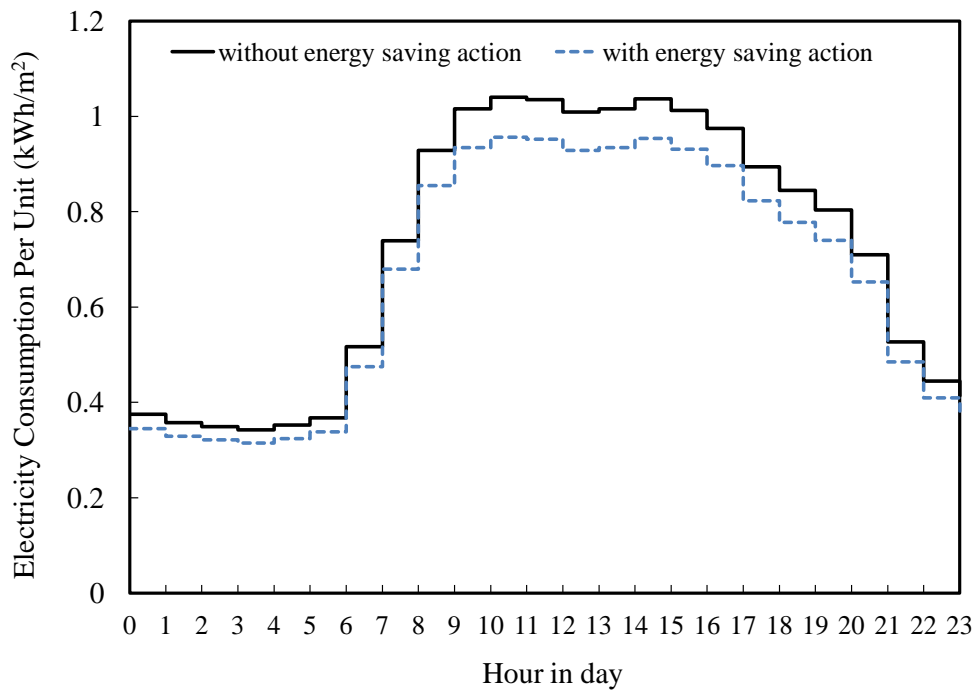

Figure 6-24 Load profile of electricity saving method from lighting side  
in hospital (method 2)

(Source: Agency for natural resources and energy)

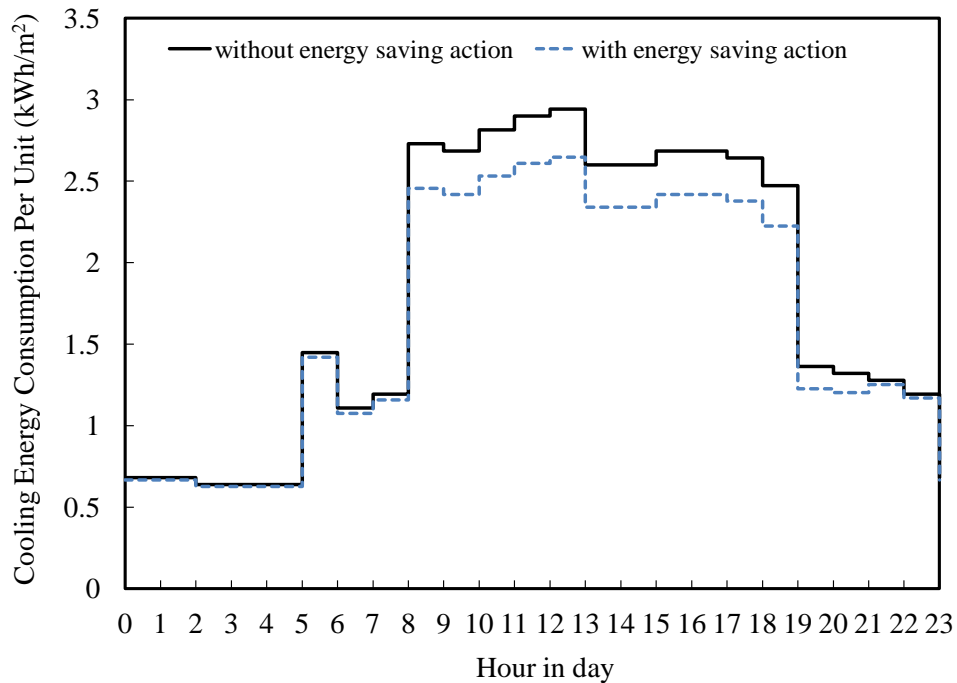

Figure 6-25 Load profile of electricity saving method from AC side  
in hospital (method 3)

(Source: Agency for natural resources and energy)

## CHAPTER SIX: ANALYSIS OF THE EFFECTS OF DYNAMIC PRICING AND ENERGY SAVING TECHNOLOGIES ON THE COST PERFORMANCE IN DIFFERENT TYPES OF BUILDING

Figure 6-23 and 6-24 are the electricity load profiles of two electricity saving methods from lighting side in hospital. According to the data of agency for natural resources and energy, we can get that changing the traditional lighting to LED lighting can realize 40% electricity saving; Decreasing the lighting of office in hospital to 50% of original one (On-call room; Release of information department; etc) can realize 4% electricity saving; Turning off the lights in the area that is not used can also realize 4% electricity saving.

Figure 6-25 is the cooling load profile of electricity saving methods from air-conditioning side in hospital. The use of AC here cannot be sharply decreased because of that many operation and treatment in hospital need the appropriate temperature, during that process, AC is particularly important. According to the data of agency for natural resources and energy, it also can be known that water spraying to the outdoor unit of air conditioning can realize 4% energy saving; both using thermal insulation and turning off AC in the area that is not used can realize 1% energy saving.

### 6.3.2.2 Electricity cost reduction effect of different actions

Figure 6-26 is the year cost reduction effect of three electricity saving methods referred above. According to this figure, it is no doubt that method 1 which changing the traditional lighting to LED lighting is the most cost saving one. Different from residential house, in hospital, the energy consumption of lighting and air-conditioning is almost similar. Thus, the 40% electricity saving effect caused by changing lighting to LED plays a significant role in reducing electricity cost of hospital. Method 1 can realize 14 million cost saving one year and it is also can be known that method 2 and method 3 have the similar cost saving effect, reached to 2 million JPY one year. Here, as for method 3 which take action from AC side, the reason why it can only realize limited energy saving effect is that in the occasion of treatment and operation, AC must be utilized to maintain the indoor temperature, the energy consumption cannot be decrease much more in

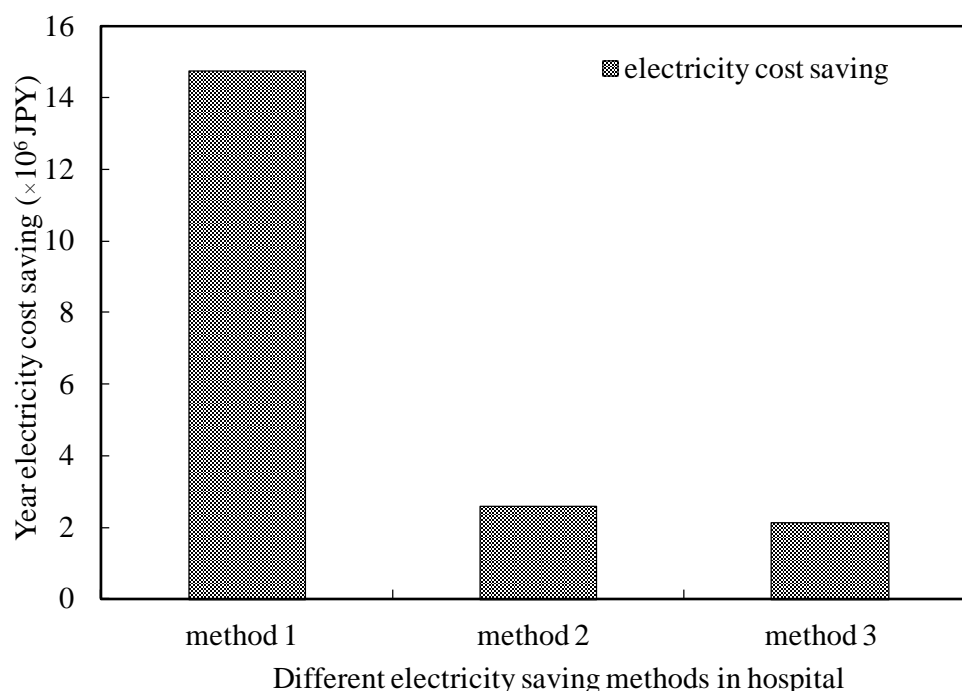

Figure 6-26 Year cost reduction effect of different electricity saving methods in hospital

## CHAPTER SIX: ANALYSIS OF THE EFFECTS OF DYNAMIC PRICING AND ENERGY SAVING TECHNOLOGIES ON THE COST PERFORMANCE IN DIFFERENT TYPES OF BUILDING

that situation.

### 6.3.3 The case of office

Figure 6-27 is the office's electricity consumption by end use. It can be seen that air conditioning represents a significant share of the total electricity consumption, reached to 48%. Followed by lighting which accounts for about 24%. Take these two factors into consideration together, it account for almost 72% of office's total electricity consumption. Based on this situation, we can take electricity saving actions from these three aspects, air-conditioning, lighting and OA equipments.

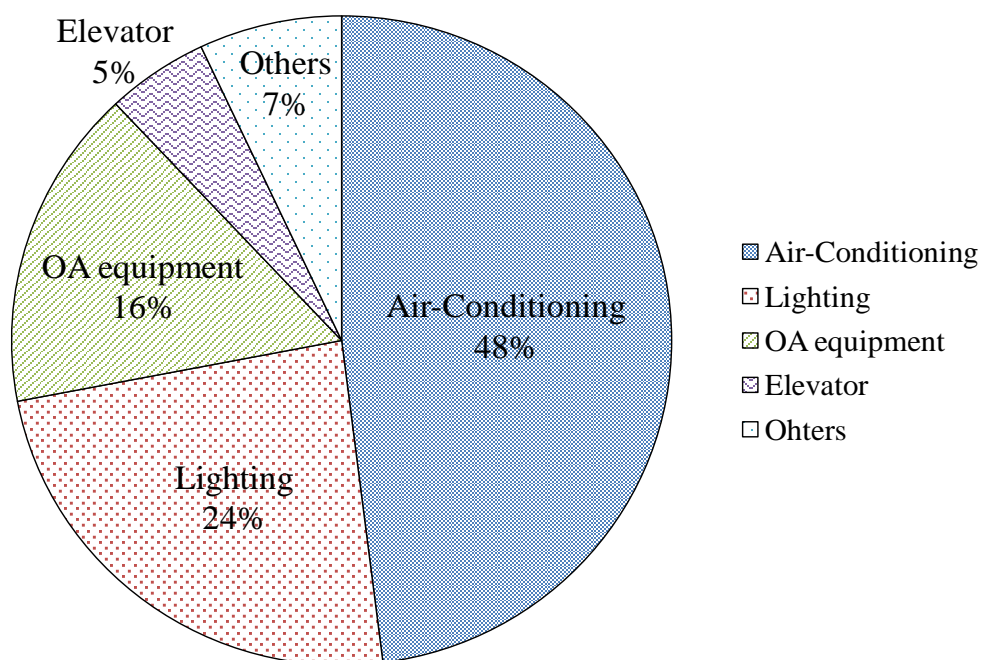

Figure 6-27 Electricity consumption by end-use of office

(Source: Agency for natural resources and energy)

#### 6.3.3.1 Introduction of energy saving actions in office

Several related items can be considered to cut electricity consumption of offices including the frequent turning off of lights, air conditioners and office automation machines. Table 6-10 is the detailed contents of electricity saving actions in offices.

Take the data of agency for natural resources and energy as reference. For air-conditioning side, action 1 can realize 4% electricity saving effect. Then it followed by action 3 and action 2, can separately reached to 3% and 2% electricity saving effect. For lighting side, as same as hospital, changing traditional lights to LED lights is the most effective energy saving method. In addition, decrease the lighting of office to 50% also has obvious electricity saving effect, reached to 13%. For OA equipment side, turn off office equipments when it is not needed can realize 3% electricity saving and set computers' brightness can realize 2% electricity saving.

## CHAPTER SIX: ANALYSIS OF THE EFFECTS OF DYNAMIC PRICING AND ENERGY SAVING TECHNOLOGIES ON THE COST PERFORMANCE IN DIFFERENT TYPES OF BUILDING

Table 6-10 Common electricity saving actions in offices

Electricity saving actions in offices	
Air-conditioning side	(1) Set the room temperature 2°C higher, reached to 28°C
	(2) Turn off the air-conditioning when it is not used
	(3) Install heat-reducing shades and blinds
Lighting side	(4) Decrease the lighting of office to 50%
	(5) Turn off the lights in the area that is not used (meeting room; corridor, etc)
	(6) Change the traditional lighting to LED lighting
OA equipments side	(7) Turn off office equipments when it is not needed at night or on the weekends.
	(8) Set the personal computer monitors' preset brightness from maximum to medium

Table 6-11 Four electricity saving methods in office

	Whole day
Method 1	Set the room temperature 2°C higher, reached to 28°C (only peak period 13:00-15:00); Turn off the air-conditioning when it is not used
Method 2	Decrease the lighting of office to 50% Turn off the lights in the area that is not used (meeting room; corridor, etc)
Method 3	Change the traditional lighting to LED lighting
Method 4	Turn off office equipments when it is not needed at night or on the weekends.

According to table 6-10, four methods were proposed to office consumers to saving their electricity use from different sides (air-condition; lighting; OA equipments). Detailed information can be seen in table 6-11.

Figure 6-28 is the cooling load profile of electricity saving method from air-conditioning side in office. In the peak period from 13:00 to 15:00 which have high electricity price, it can realize 4% electricity saving through setting indoor temperature 2°C higher. Figure 6-29 and 6-30 are the electricity load profiles of method 2 and method 3 in office. It can be clearly see that method 3 which make LED instead of traditional lights is more energy efficient than method 2. Through decreasing and turning off the lights of office, method 3 still can achieve a certain level of electricity saving.

Figure 6-31 is the electricity load profile of method 4 in office. As all we known, offices have many different kinds of automation machines, including printers, fax machines, copiers and scanners. These office equipments usually waste a lot of electricity if it be left on overnight. According to statistics, almost 30 to 40% of office equipment is left on at night and on weekends. Therefore, take appropriate electricity saving measures aimed at this part is meaningful.

**CHAPTER SIX: ANALYSIS OF THE EFFECTS OF DYNAMIC PRICING  
AND ENERGY SAVING TECHNOLOGIES ON THE COST PERFORMANCE  
IN DIFFERENT TYPES OF BUILDING**

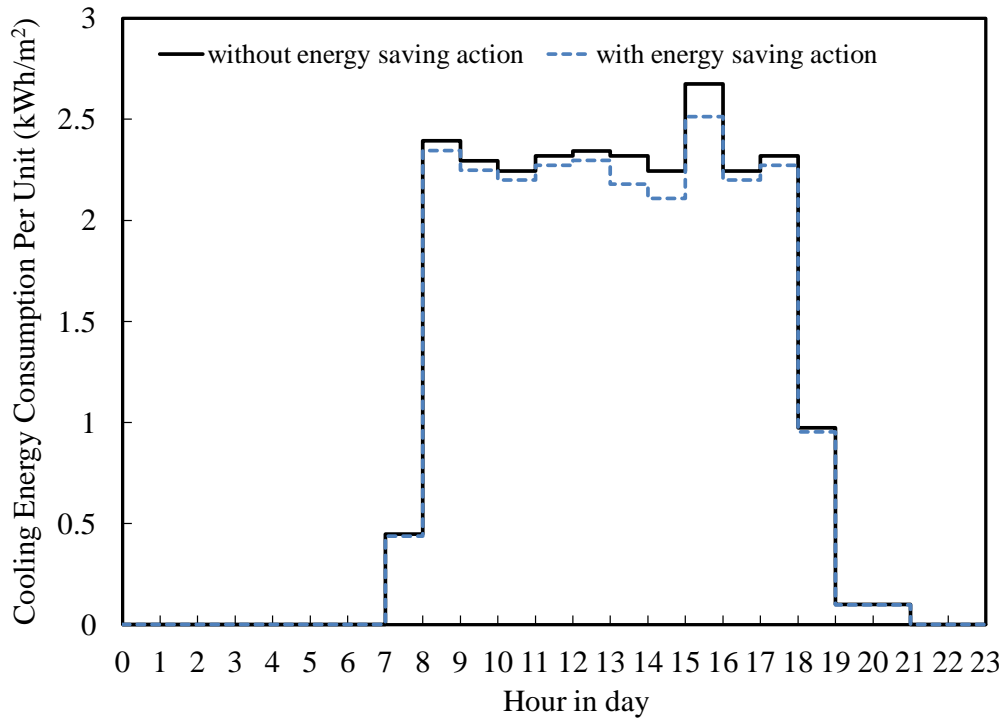

Figure 6-28 Load profile of electricity saving method from AC side in office (method 1)

(Source: Agency for natural resources and energy)

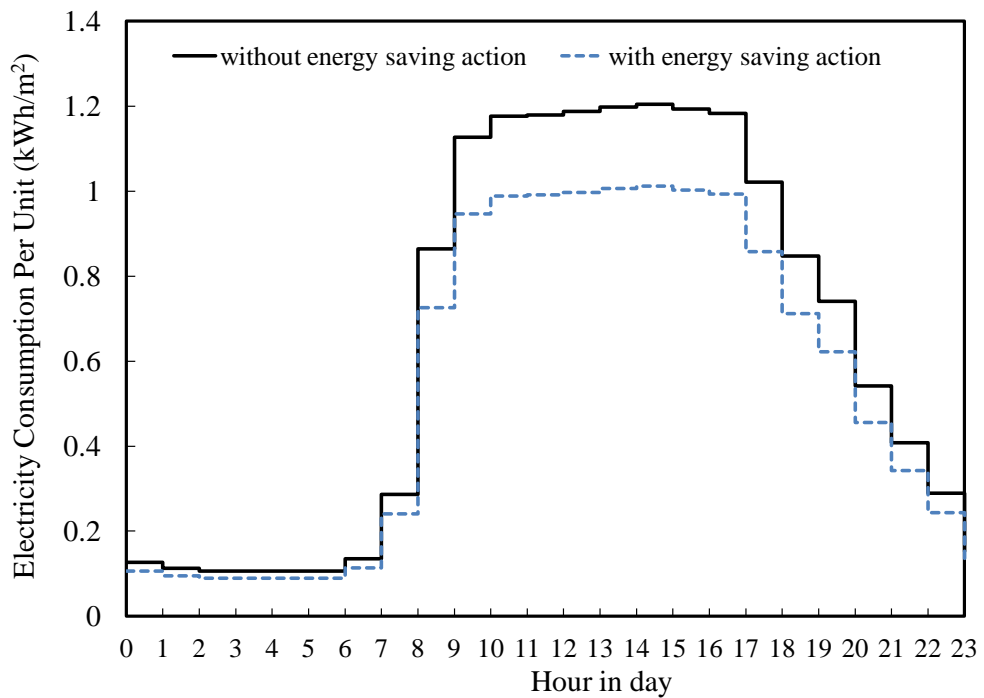

Figure 6-29 Load profile of electricity saving method from AC side in office (method 2)

(Source: Agency for natural resources and energy)

**CHAPTER SIX: ANALYSIS OF THE EFFECTS OF DYNAMIC PRICING  
AND ENERGY SAVING TECHNOLOGIES ON THE COST PERFORMANCE  
IN DIFFERENT TYPES OF BUILDING**

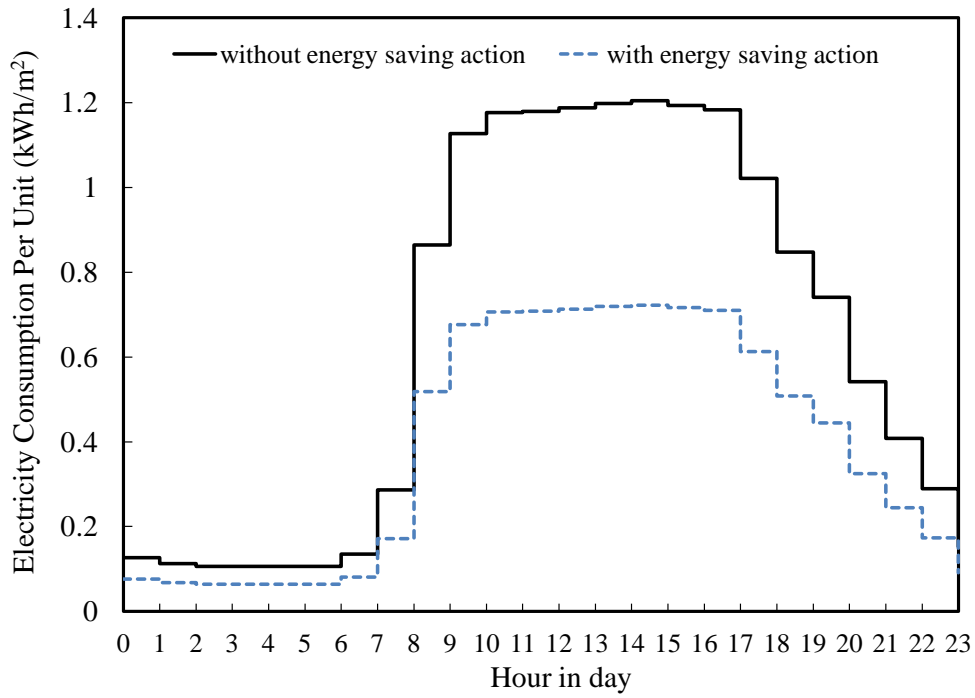

Figure 6-30 Load profile of electricity saving method from AC side in office (method 3)

(Source: Agency for natural resources and energy)

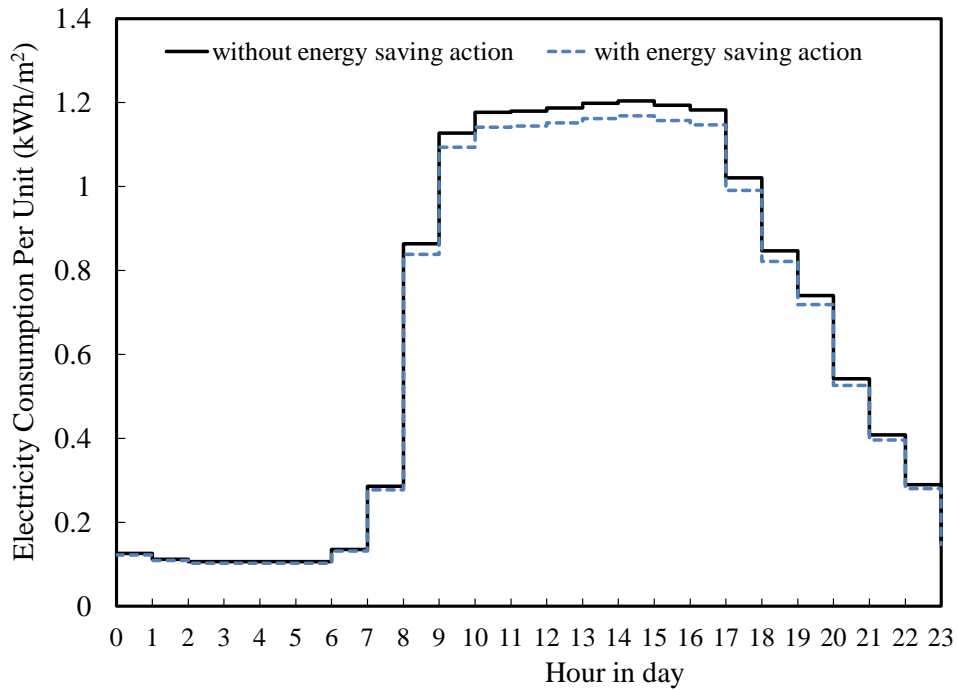

Figure 6-31 Load profile of electricity saving method from AC side in office (method 4)

(Source: Agency for natural resources and energy)



**CHAPTER SIX: ANALYSIS OF THE EFFECTS OF DYNAMIC PRICING  
AND ENERGY SAVING TECHNOLOGIES ON THE COST PERFORMANCE  
IN DIFFERENT TYPES OF BUILDING**

**6.3.3.2 Electricity cost reduction effect of different actions**

Figure 6-32 is the year electricity cost reduction effect of different electricity saving methods in office. As same as hospital, method 3 which using LED instead of traditional lights is the most cost saving one, owing to the high efficiency of LED. On the contrary, method 4 which related to OA equipment only can realize cost saving of 60 thousands JPY per year, it is lower than any other

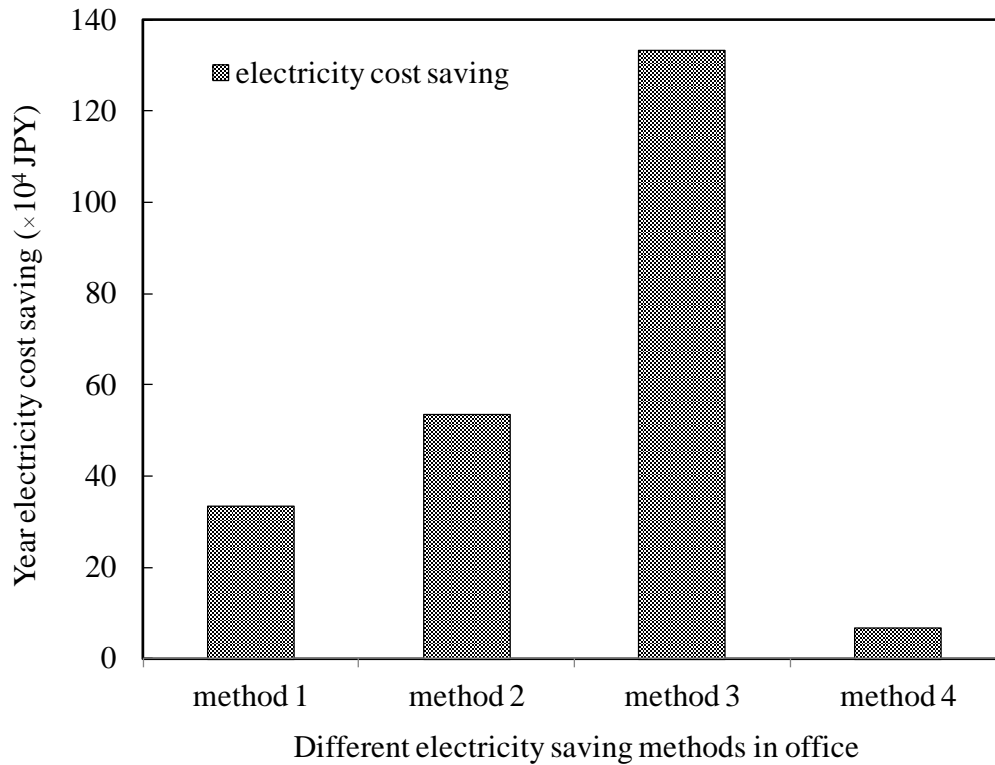

Figure 6-32 Year cost reduction effect of different electricity saving methods in office

electricity saving methods. Although the cost saving effect of it is much lower than method 3, it still can release electricity bill of office consumers and easy for everybody to implement. As for method 1 and method 2, the cost reduction effect of method 2 is a little better than method 1.

## CHAPTER SIX: ANALYSIS OF THE EFFECTS OF DYNAMIC PRICING AND ENERGY SAVING TECHNOLOGIES ON THE COST PERFORMANCE IN DIFFERENT TYPES OF BUILDING

### 6.3.4 The case of hotel

Figure 6-33 is the electricity consumption of hotel by end use. It can be seen that lighting is a major consume factor of total electricity, reached to 31%. Followed by air-conditioning which accounts for about 26%, take these two factors into consideration together, it account for 57%, more than half of hotel's total electricity consumption.

In addition, the electricity usage of outlets accounts for 4%; elevator accounts for 8%; the other electricity usage accounts for 31%. Taking this proportion as reference, we should mainly take energy-saving technology in hotel from air-conditioning and lighting side.

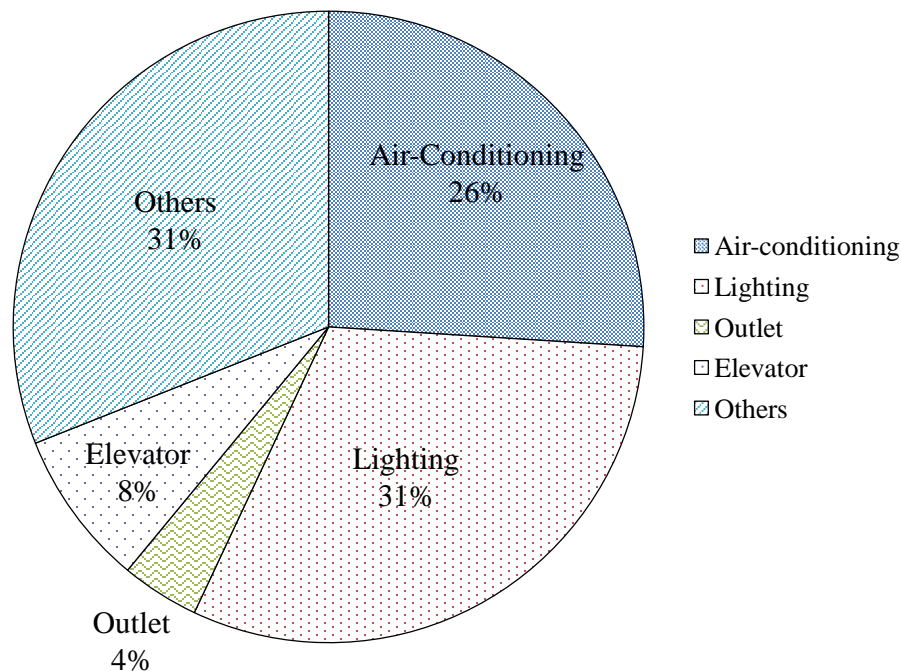

Figure 6-33 Electricity consumption by end-use of hotel

(Source: Agency for natural resources and energy)

#### 6.3.4.1 Introduction of energy saving actions in hotel

The consumption of electricity in hotel accounts for a large part of its energy bills. Under the background of widely use of dynamic price in an area, how to save electricity as more as possible is essential to hotel consumers. Following are some tips to help reduce hotel's electricity consumption, detailed information was shown in table 6-12. These environmentally responsible practices may help hotel decrease their electricity cost as well as benefit to our resources and environment.

According to table 6-12 and the data from agency for natural resources and energy, three methods were be set to investigate its cost saving effect. These methods were mainly illustrated from air-conditioning side and lighting side. In addition, setting the non guest room temperature 2°C higher and turning off the air-conditioning when it is not used can realize 1% energy saving respectively; decreasing the lighting of non guest room to 50% can realize 13% energy saving; decreasing the air supply volume to 50% can realize 2% energy saving; changing the traditional lighting to LED lights can realize 40% of lighting energy saving.

## CHAPTER SIX: ANALYSIS OF THE EFFECTS OF DYNAMIC PRICING AND ENERGY SAVING TECHNOLOGIES ON THE COST PERFORMANCE IN DIFFERENT TYPES OF BUILDING

Detailed information of three methods was shown in table 6-13.

Table 6-12 Common electricity saving actions in hotel

Electricity saving actions in hotel	
Air-conditioning side	(1) Set the non guest room temperature 2°C higher, reached to 28°C (office, corridor, lobby, etc) (2) Turn off the air-conditioning when it is not used (party room, meeting room, etc) (3) As for outside air supply system or bathroom exhaust system, decrease the air supply volume to 50%
Lighting side	(4) Decrease the lighting of non guest room to 50% (5) Change the traditional lighting to LED lighting
Others	(6) Operate washing machines and dryers at the hotel's laundry area during off-peak hours. Operate washing machines only with full loads. (7) Switch off and unplug all appliances after their use (coffee makers, mixers, blenders, grills, fryers, stove etc).

Table 6-13 Three electricity saving methods in hotel

	Whole day
Method 1	Change the traditional lighting to LED lighting
Method 2	Decrease the lighting of non guest room to 50%
Method 3	Set the non guest room temperature 2°C higher (13:00-15:00); Turn off the air-conditioning when it is not used Decrease the air supply volume to 50%

Figure 6-34, 6-35, 6-36 are load profiles of different electricity saving methods in the hotel.

As same as other kinds of buildings, method 1 which make LED instead of traditional lights is the most energy efficient one. Method 2 also can realize considerable electricity saving. It can only realize a small percentage of load decrease due to the low reduction ratio of method 3 from air-conditioning side, as figure 6-36 shown.

### 6.3.4.2 Electricity cost reduction effect of different actions

Figure 6-37 is the year cost reduction effect of three electricity saving methods in hotel. According to this figure, we can know that method 1 which changing the traditional lighting to LED lighting is the most cost saving one, corresponding to the load decrease profile. In addition, due to the lighting accounts for the bigger proportion of total electricity consumption and significantly electricity saving ability of two methods, the cost saving effect of method 1 and method 2 which aimed at lighting is better than method 3. Method 1 can realize almost 14 million cost saving one year and method 2 can realize almost 6 million cost saving one year

Method 3 can only realized limited energy saving effect caused that hotel has its own operating characteristic. Due to the priority of customers, AC must be utilized to make sure the comfort of consumers, the use of it can't be decreased to meet the electricity saving.

**CHAPTER SIX: ANALYSIS OF THE EFFECTS OF DYNAMIC PRICING  
AND ENERGY SAVING TECHNOLOGIES ON THE COST PERFORMANCE  
IN DIFFERENT TYPES OF BUILDING**

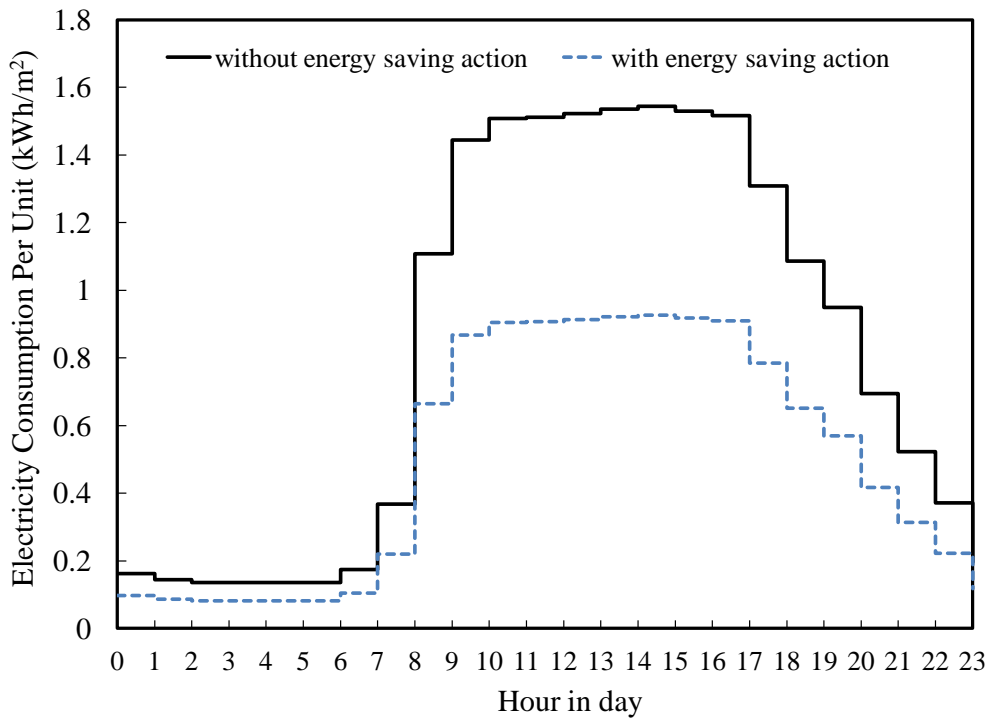

Figure 6-34 Load profile of electricity saving method in hotel (method 1)  
(Source: Agency for natural resources and energy)

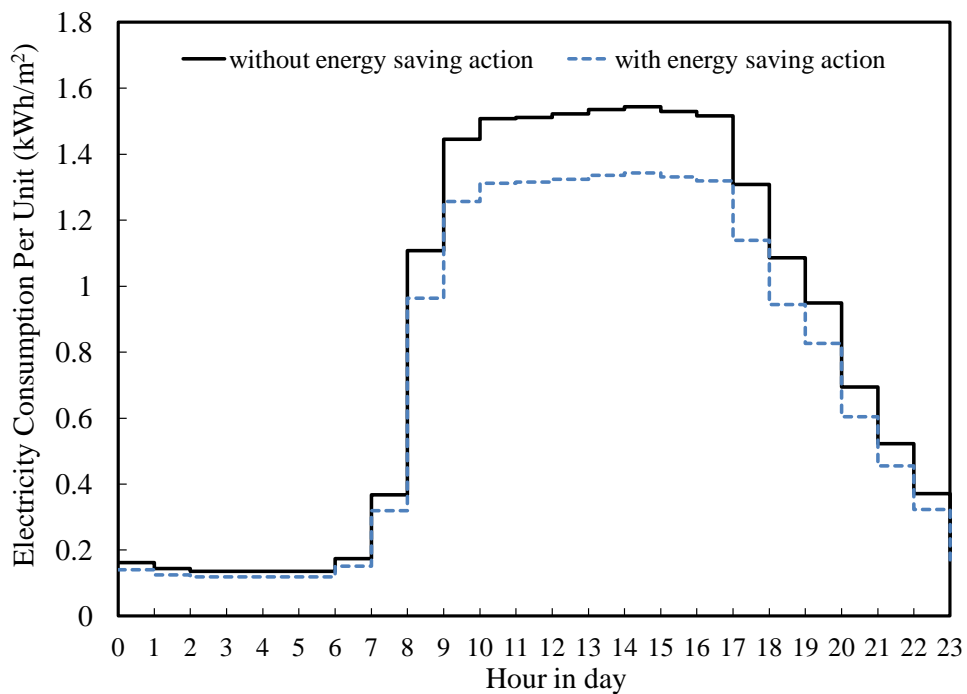

Figure 6-35 Load profile of electricity saving method in hotel (method 2)  
(Source: Agency for natural resources and energy)

**CHAPTER SIX: ANALYSIS OF THE EFFECTS OF DYNAMIC PRICING  
AND ENERGY SAVING TECHNOLOGIES ON THE COST PERFORMANCE  
IN DIFFERENT TYPES OF BUILDING**

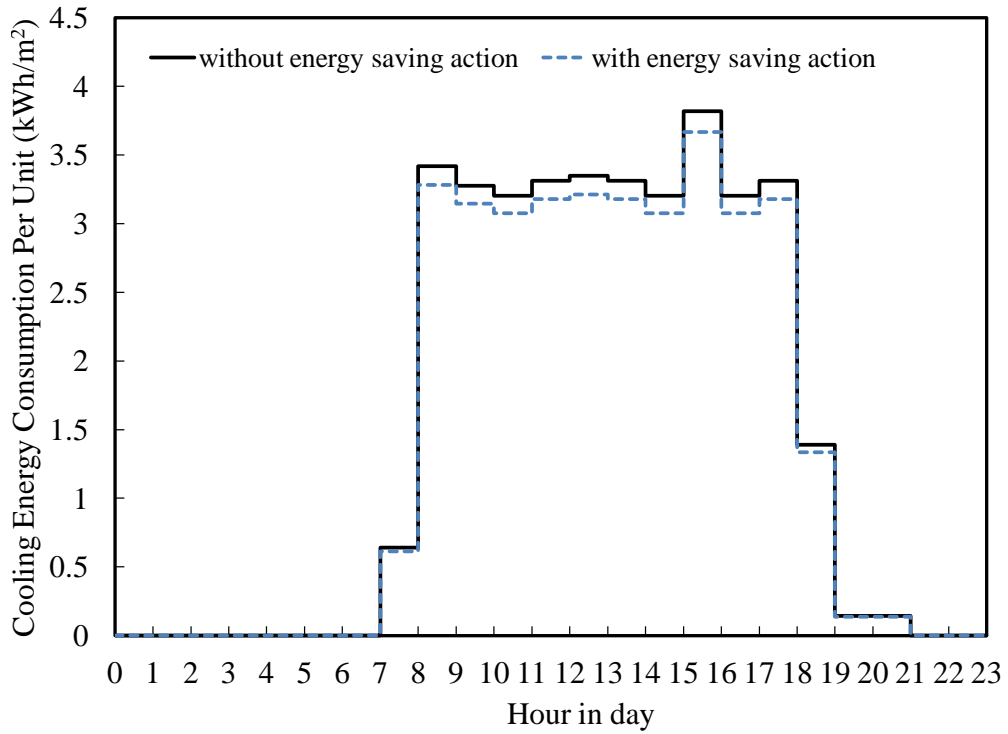

Figure 6-36 Load profile of electricity saving method in hotel (method 3)

(Source: Agency for natural resources and energy)

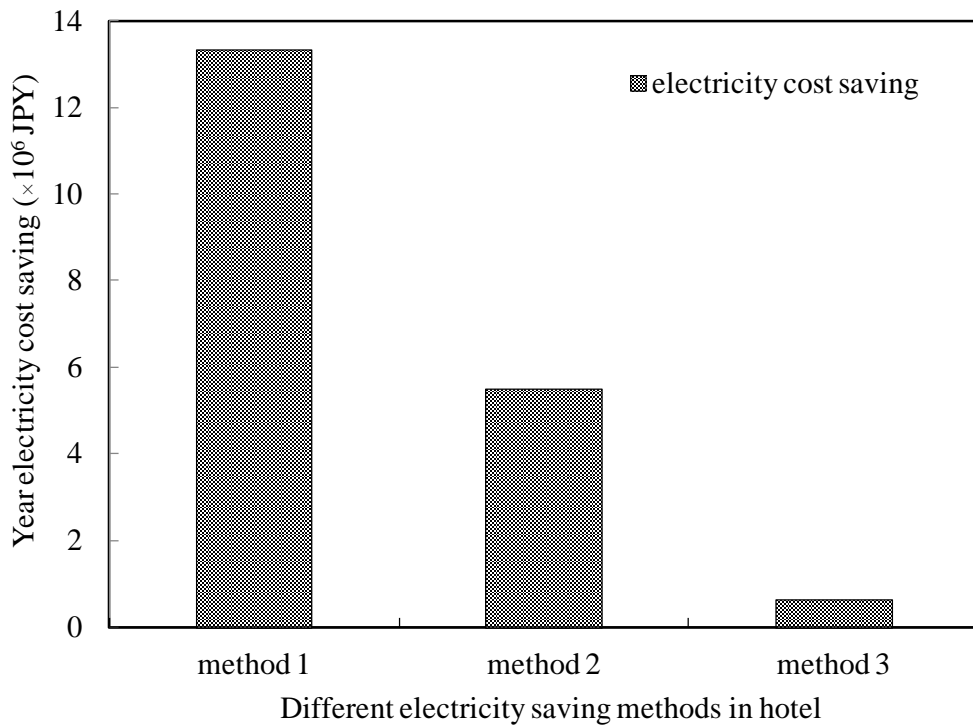

Figure 6-37 Year cost reduction effect of different electricity saving methods in hotel

## CHAPTER SIX: ANALYSIS OF THE EFFECTS OF DYNAMIC PRICING AND ENERGY SAVING TECHNOLOGIES ON THE COST PERFORMANCE IN DIFFERENT TYPES OF BUILDING

### 6.4 Summary

This chapter has investigated the effects of dynamic pricing system on the cost performance of different buildings in two scenarios, present scenario and demand response scenario. In the present scenario, we can get the conclusion that, as for common consumers, dynamic pricing can't bring economic benefit to them if they have no demand response. In the demand response scenario, we can get the conclusion that even simple electricity saving actions, it also can realize amount of cost reduction for consumers who using dynamic pricing.

The main and specific results can be summarized as follows:

- (1) If consumers maintain their original working habits and lifestyle unchanged, every month of all spending on electricity that using dynamic price is higher than that of using regular price. In august, the cost of using dynamic price is 41% higher than that of using regular price for residential house; 51% for office and 40% for hospital and hotel.
- (2) In demand response scenario, using some simple and common energy saving actions can help consumers reduce their electricity bill. As for residential consumers, the energy saving actions that all residents try to use air-conditioning in one room is the most effective method, it can bring almost 16000 JPY cost saving effect. As for hospital, office and hotel, the method which changing the traditional lighting to LED lighting is the most cost saving one.

Generally, DP is a kind of method that can effectively reduce the peak load. However, according to the results of many DP experiments, people are not always responds to DP well in real situation, owing to that some of them still want to remain their original lifestyle and comfortable living conditions. For example, consumers usually do less response to DP while extremely weather occurs. What's more, even consumers would take some energy saving actions respond to DP, economy loss will still exist compared to using regular electricity price. Therefore, make the balance between the utilization of DP and the benefit of consumers is essential to the further development of smart grid.

## CHAPTER SIX: ANALYSIS OF THE EFFECTS OF DYNAMIC PRICING AND ENERGY SAVING TECHNOLOGIES ON THE COST PERFORMANCE IN DIFFERENT TYPES OF BUILDING

### REFERENCE

- [1] International Energy Agency (IEA), World Energy Outlook 2013, OECD/IEA, 2013.
- [2] Borenstein, Severin. 2007. "Wealth Transfers Among Large Customers from Implementing Real-Time Retail Electricity Pricing." The Energy Journal.
- [3] Faruqui, Ahmad and B. Kelly Eakin (co-editors) (2000). Pricing in Competitive Electricity Markets, Kluwer Academic Publishers.
- [4] Mitchell, Bridger and Jan Acton. 1980. "The Effects of Time-of-Use Rates in the Los Angeles Electricity Study." RAND, N-1533-DWP/HF.
- [5] Crew, Michael A., Chitru S. Fernando and Paul R. Kleindorfer (1995). "The Theory of Peak Load Pricing: A Survey," Journal of Regulatory Economics, 8: 215-248.
- [6] Chao, Hung-po and Robert Wilson (1987). "Priority Service: Pricing, Investment and Market Organization," American Economic Review, 77:5, 899-916.
- [7] Federal Energy Regulatory Committee. A national assessment of demand response potential, staff report, Washington, DC; 2009.
- [8] Guy R. Newsham, Brent G. Bowker. 2010. "The effect of utility time-varying pricing and load control strategies on residential summer peak electricity use: A review." Energy Policy, Volume 38, Issue 7, Pages 3289-3296.
- [9] Borenstein, Severin (2002). "The Trouble with Electricity Markets: Understanding California's Restructuring Disaster," Journal of Economic Perspectives, 16:1, 191-211, Winter.
- [10] <http://criepi.denken.or.jp/>. Central Research Institute of Electric Power Industry
- [11] Karen Herter, Patrick McAuliffe, Arthur Rosenfeld. "An exploratory analysis of California residential customer response to critical peak pricing of electricity." Volume 32, January 2007, Pages 25-34
- [12] Braithwait, Steven D., Daniel Hansen, and Jess D. Reaser (2010). "2009 Load Impact Evaluation of California Statewide Critical-Peak Pricing Rates for Non-Residential Customers: Ex Post and Ex Ante Report," CALMAC Study ID SDG244, April 19.
- [13] U.S. Energy Information Administration, Today in energy, APRIL 4, 2011.
- [14] U.S. Federal Energy Regulatory Commission (FERC). 2011. "2010 Assessment of Demand Response and Advanced Metering. Staff Report (February 2011).
- [15] <http://www.rmi.org/> Rocky Mountain Institute
- [16] <http://www.energy-insights.com/>, 2008
- [17] Ahmad Faruqui, Sanem Sergici. 2010. "Household Response to Dynamic Pricing of Electricity-A Survey of the Empirical Evidence". Available at SSRN: <http://ssrn.com/abstract=1134132>
- [18] <http://www.crai.com/>, Charles River Associate.
- [19] ISO/RTO Council
- [20] <http://www.isorto.org/site/c.jhKQIZPBIImE/b.2604471/k.B14E/Map.html>
- [21] Federal Energy Regulatory Commission, Assessment of demand response and advanced metering: 2006: starff-report [EB/OL] . (2007-07-21) [2009-10-02]
- [22] <http://www.meti.go.jp/setsuden/summer2013.html>.
- [23] Roger Levy, Joint California Workshop. Advanced Metering Results and Issues [Z] . 2004.





## **CHAPTER SEVEN: ANALYSIS AND EVALUATION OF ELECTRICITY DYNAMIC PRICING IN BUILDINGS WITH DIFFERENT ENERGY SAVING TECHNOLOGIES**

7.1 Introduction

7.2 Introduction of energy saving technologies

7.2.1 Introduction of storage battery

7.2.2 Introduction of photovoltaic

7.2.3 Introduction of distributed energy system

7.3 Case study 1- Analysis and evaluation of DP in residential house

7.3.1 Case setting

7.3.2 Analysis results and discussion

7.4 Case study 2- Analysis and evaluation of DP in Hospital

7.4.1 Case setting

7.4.2 Analysis results and discussion

7.5 Case study 3- Analysis and evaluation of DP in office

7.5.1 Case setting

7.5.2 Analysis results and discussion

7.6 Case study 4- Analysis and evaluation of DP in hotel

7.6.1 Case setting

7.6.2 Analysis results and discussion

7.7 Case study 5- Analysis and evaluation of DP in community

7.7.1 Case setting

7.7.2 Analysis results and discussion

7.8 Summary



## CHAPTER SEVEN: ANALYSIS AND EVALUATION OF ELECTRICITY DYNAMIC PRICING IN BUILDINGS WITH DIFFERENT ENERGY SAVING TECHNOLOGIES

### 7.1 Introduction

Kyoto Protocol was widely known as an international act to restrict the greenhouse gas (GHG) emission. Under this background, Japan promised to reduce six percent of the GHG emission, compared with 1990. Nevertheless, according to the statistic data, even Japan had paid much attention to improving its energy using efficiency and achieved a remarkable reward in the year 2009. Its yearly GHG emissions have not yet reached the standard, on the contrary, the GHG emissions have increased 4.2% until the year 2010. What's more, Fukushima nuclear accident make Japan suffered a serious "power shortage." The lack of electricity supply dramatically hampered the stability of Japanese industrial production and national economy development. The power shortage also had a huge impact on the normal life of the Japanese people. In this context, the Japanese government work hard to promote domestic power system reform, so that energy structure can be adjusted suitably, especially the power supply and demand structure. Through this revolution of electricity system, ensure the domestic energy supply and maintain the steady growth of macroeconomic.

In order to realize the objective which referred above and establish more effective energy system, the Japanese motivation toward "smart grid" has been suggested in its new energy strategies (decided on Dec.30th, 2009). Four areas are conducted to be the demonstration trial sites, known as "smart community", it is the basic unit in the smart evolution for the country.

Electricity dynamic pricing represents one of the most significant evolutionary developments in pricing systems as they enable the participation of both consumers and the power supply enterprises. This new pricing system contributes to integrating renewable energy and improving energy using efficiency. The research about the DP has been carried out world widely for more than ten years and they focused on the performance of DP and how to realize more effective pricing system. Based on the discussion of chapter 6, even DP has the potential to help to reduce the energy load in peak period, it will results in the economy losses to the consumers both in present scenario and tiny demand response scenario. Therefore, energy saving technologies was proposed to be introduced into buildings in order to solve the contradiction between the deployment of DP and the economy benefit of consumers. Except for two common and widely used energy saving technologies (the storage battery and photovoltaic), distributed energy system also has been taken into consideration in the case of the DP utilization in the area. Increasing concern on the depletion of fossil energy resources and the pollution of the environment has increased the importance of developing high efficiency energy generation techniques, known as distributed energy resources. The distributed energy system is a key underpinning of smart grid. The well planned distributed energy system can serve to shift the electricity demand away from the peak periods, making the energy supply system more efficiently.

This chapter introduced some related energy saving technologies including storage battery, photovoltaic and distributed energy system. Meanwhile, it gives an analysis and evaluation of electricity dynamic pricing in different buildings which equipped with different energy saving technologies under the condition that if consumers do not well respond to DP as anticipated. The primary energy saving effect and environmental impact of each energy saving technology has also been discussed.

## CHAPTER SEVEN: ANALYSIS AND EVALUATION OF ELECTRICITY DYNAMIC PRICING IN BUILDINGS WITH DIFFERENT ENERGY SAVING TECHNOLOGIES

### 7.2 Introduction of energy saving technologies

There are different kinds of energy saving technologies which can be introduced into buildings to reduce the energy consumption of consumers, meanwhile, solve the environmental issues. At present, the most common energy saving technologies were used in whether residential house or commercial building are storage battery and photovoltaic, owing to its convenience and policy support. Both of them all can help customers to use less electricity from utility grid during the peak period which equipped with high electricity tariff. As for the whole area which contains various types of buildings, distributed energy system was considered to be introduced into the area to realize the better energy allocation due to the large load value and complex load characteristics. The introduction of related energy saving technologies will be presented in following contents.

#### 7.2.1 Introduction of storage battery

Storage battery is an electrochemical device storing the chemical energy and releasing the energy when necessary. The batteries usually have been charged in the case of low peak load or electricity consumption at night, and using them in the on-peak period of the day. Owing to its unique characteristic, storage battery is suitable for us to solve the contradiction between the improvement of whole grid and the consumers' economic benefit.

In this paper, as for commercial buildings, the storage battery which has been selected is a kind of battery with large-capacity called NAS. It is possible to reduce the extra electricity bill which caused by using DP through introducing storage battery, meanwhile, it also can help to improve the efficiency of electric power grid. Table 7-1 is the features of the storage battery which be used in commercial buildings. The capacity and charge-discharge mode of SB in different buildings is mainly decided by the electricity load of each building.

As for residential consumers, the storage battery what we selected is ordinary type. Table 7-2 is the characters of storage battery which be introduced into the residents. The charge-discharge efficiency of storage battery is 0.8. In terms of operation mode of SB, this paper assumes that storage battery is charged from 22:00 to 8:00 and discharged from 8:00 to 22:00 continuously. In which, the output power of storage battery is 0.45 in the period from 8:00 to 12:00 and 15:00 to 22:00, 1 in the period from 12:00 to 15:00. The capacity of storage battery which we have selected is 10kW according to the maximum load of residential house. The initial cost of storage battery is 300000JPY/kWh. In order to further analyze the introduction effect of storage battery in residential house, this paper assumes that the initial cost will fall as the technology development. The lifetime of storage battery is 15 years. Figure 7-1 shows the charge-discharge curve of storage battery.

Table 7-1 Features of the storage battery used in commercial buildings

Items	Characters
Life expectancy	15 years
Initial cost (JPY/kWh)	25000
Charge time	22:00-8:00
Discharge time	8:00-22:00
Charge-discharge efficiency	0.9

## CHAPTER SEVEN: ANALYSIS AND EVALUATION OF ELECTRICITY DYNAMIC PRICING IN BUILDINGS WITH DIFFERENT ENERGY SAVING TECHNOLOGIES

Table 7-2 Storage battery information of residential house

Charge time(22:00-8:00)			
Charge-discharge efficiency		0.8	
Discharge time(8:00-22:00)	Output power(kWh)	8:00-12:00,15:00-22:00	0.45
		12:00-15:00	1
Charge-discharge efficiency	0.8		
Initial cost (JPY/KWh)	300000		
Capacity of battery(KWh)	10		
Life time(years)	15		

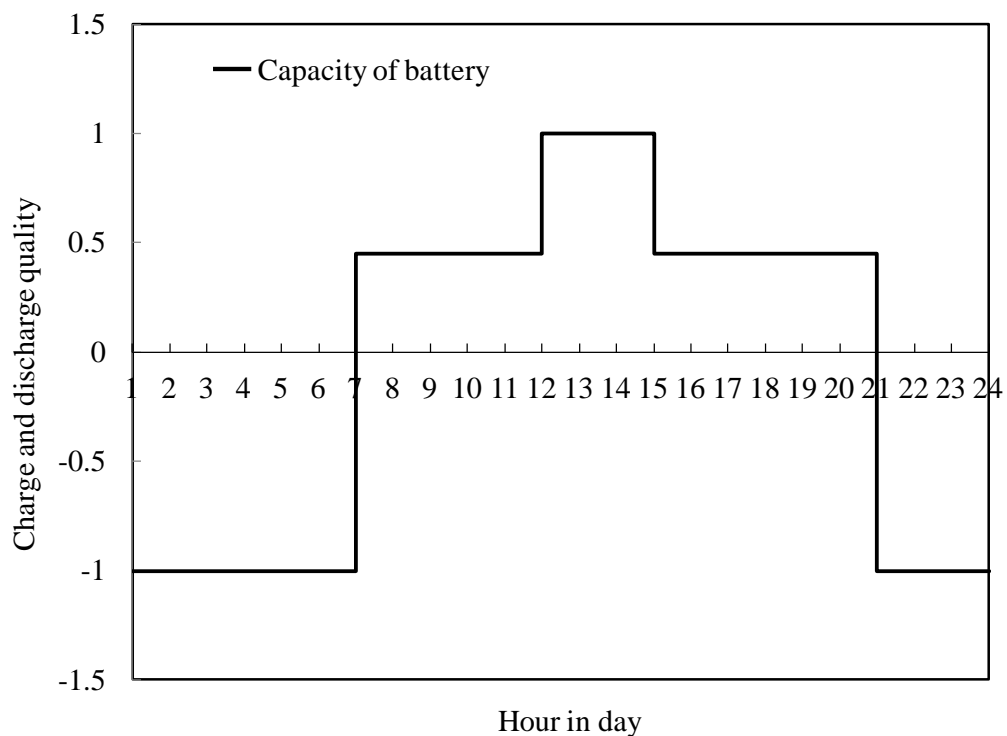

Figure 7-1 Charge-discharge mode of storage battery in residential house

## CHAPTER SEVEN: ANALYSIS AND EVALUATION OF ELECTRICITY DYNAMIC PRICING IN BUILDINGS WITH DIFFERENT ENERGY SAVING TECHNOLOGIES

### 7.2.2 Introduction of photovoltaic

Photovoltaic (PV) is a device which generating electrical power using sun resources. Photovoltaic are arrays of cells containing a solar photovoltaic material that converts solar radiation or energy from the sun into direct current electricity. Due to the growing demand for renewable energy sources, the manufacturing of solar cells and photovoltaic arrays has advanced considerably in recent years, and its costs also have dropped.

Solar radiation situation primarily influences the selection of local site for PV installation. Local climate and environment factors such as temperature, humidity, precipitation, and wind will constrain the output of PV array. Nevertheless, these are all secondly effects when compared with isolation intensity. As the third largest island of Japan, Kyushu has the advantaged conditions of climate and geothermal character. The annual cumulated hourly irradiation and hourly maximal irradiation are shown as figure 7-2. According to this profile, it can be seen that maximum irradiation is at 12:00 in the midday.

The generating capacity of photovoltaic can satisfy the electricity consumption of consumers partly. Meanwhile, when the isolation is high, in addition to provide consumers' electricity use, we can also sell the extra-electricity generated by PV to the power company, using this way to get certain profit.

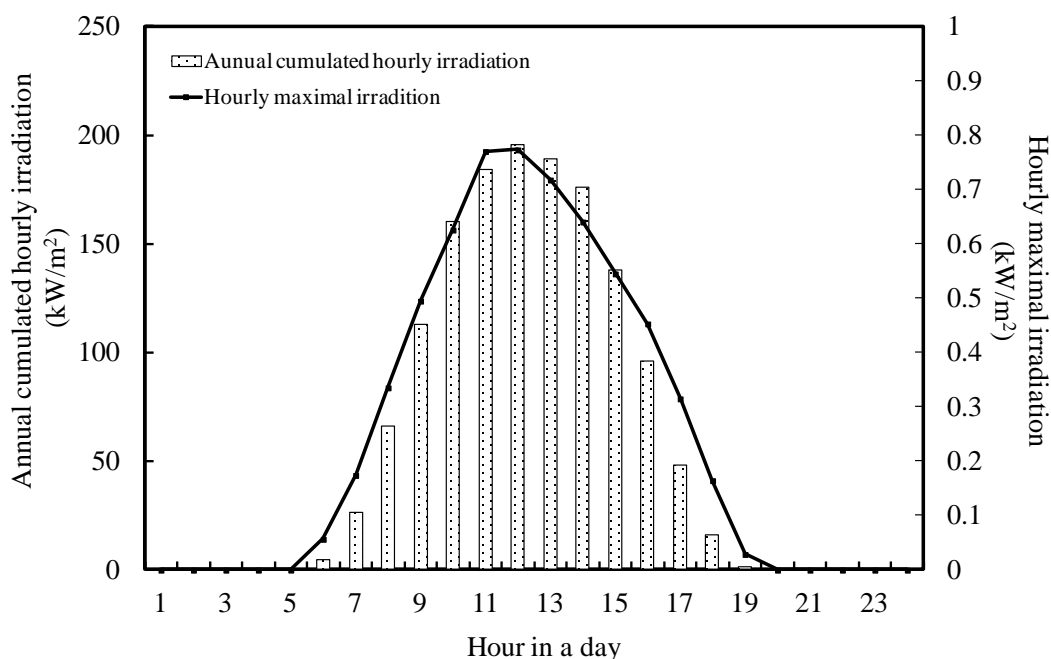

Figure 7-2 Annual cumulated hourly irradiation and hourly maximal irradiation

Detailed PV properties are shown in Table 7-3. In this paper, as for residential consumers, we choose ND-165AA model of photovoltaic panels which produced by sharp company. The output of this panel is 165 W, efficiency is 14.3%. The initial cost of the panel is 360000 JPY/kW. As for commercial consumers, the output of PV panel is 296 W, efficiency is 15.2%. The initial cost is 320000 JPY/kW. The life time of both two kinds of panels is 20 years.

Generally, the capacity of system depends on the building's real energy needs. In this part, we did not list the detail information of PV capacity.

## CHAPTER SEVEN: ANALYSIS AND EVALUATION OF ELECTRICITY DYNAMIC PRICING IN BUILDINGS WITH DIFFERENT ENERGY SAVING TECHNOLOGIES

Table 7-3 Photovoltaic System characters

	Residential house	Commercial building
Output (W)	165	296
Efficiency	14.3%	15.2%
Initial cost (JPY/kW)	360000	320000
Life time (year)	20	

### 7.2.3 Introduction of distributed energy system

Energy system begins with the extraction of primary energy resources in nature, and consists of the stage of energy conversion, energy transportation and energy utilization. Energy conversion includes purification, gasification, combustion, power generation, etc., and generates secondary energy products such as fuel, heat, electricity. Energy transportation occurs between primary energy resources and secondary energy products. Energy utilization is to provide energy services corresponding to consumer needs such as power, lighting, air conditioning and heating through utilizing secondary energy products.

Conventional energy system means collection of primary energy resources, production of secondary energy products and transportation of these. The energy industry is responsible for the supply of secondary energy products which are used by consumers in different occasions such as various home appliances and automobiles.

Distributed energy system is a system that can convert natural energy such as sunlight waste heat, biomass, wind, etc., in a suitable place and uses both these converted energy and fossil fuel to satisfy the energy demand of consumers. From the perspective of utility grid, distributed energy system can help improve the stability and safety of the energy supply system. Also for the end-user consideration, they can achieve power quality and reliability, meanwhile, enjoy lower energy cost. In recent years, distributed energy system has contributed a lot in energy saving performance and environmental protection, and also has created great merits in economic aspect, for example, it makes it possible to withdraw the initial investment which was invested in early stage. Therefore, in many countries, the input volume of power generation equipments which utilize distributed energy system, such as gas co-generation system, etc., tends to increase year by year. Based on the above explanation, Distributed energy system not only can help consumer to reduce peak load but also contributes to the saving of energy cost. It is feasible to achieve the coexistence of application of DP and the realization of consumers benefit.

## CHAPTER SEVEN: ANALYSIS AND EVALUATION OF ELECTRICITY DYNAMIC PRICING IN BUILDINGS WITH DIFFERENT ENERGY SAVING TECHNOLOGIES

### 7.3 Case study 1- Analysis and evaluation of DP in residential house

#### 7.3.1 Case setting

Introducing storage battery into residential house is conducive to decrease the additional fee caused by using dynamic pricing compared to that of using regular price. It is a good way to solve the contradiction between maintaining consumers' benefit and the improvement of power grid. However, in present situation, high initial cost of SB restricts the possibility of using SB to reduce the extra fee caused by the equipment of DP. Due to the mature development of storage battery and power grid, it will provide some possibilities for the introduction of SB in the household. One hand is that the price of peak period has the tendency to increase with the outbreak of energy crisis. The other hand is that rapid development of science and technology will cut the initial cost of SB. In this paper, we supposed that dynamic price will gradually increase from 100JPY/kWh to 250JPY/kWh as the development of power grid; the initial cost of storage battery will gradually decrease from 300,000JPY/kWh to 100,000JPY/kWh as the development of production technology.

Introducing PV into residential side also can have the same effect as SB. Consumers could use electricity generated by PV instead of using the electricity from utility grid in peak time period which have the high electricity price. Here, we choose ND-165AA model of photovoltaic panels which produced by sharp company to explore the cost effect of PV.

Four different ways were planned for the case study. We let case 1 only use the regular price. Case 2 use the dynamic price. Both case 1 and case 2 are not equips with SB or PV. Case 3 equips with PV and case 4 equips with SB. As for residential house, we do not considered the case that equipped with both SB and PV due to the high present initial cost of SB. Detailed case settings were shown in table 7-4.

Next, we will discuss the cost saving effect of SB and PV separately.

Table 7-4 Four different cases for residential house

	Electricity mode	Storage battery	Photovoltaic
Case 1	Regular price	Not have	Not have
Case 2	Dynamic price	Not have	Not have
Case 3	Dynamic price	Not have	Have
Case 4	Dynamic price	Have	Not have

#### 7.3.2 Analysis results and discussion

As shown in figure 7-3, the total cost of case 4 is gradually decreased as the increase of electricity price during peak period. We can obviously see that when the dynamic price of peak period reached at 206 JPY/kWh, the costs of case 4 and case 2 are equivalent. Therefore, we can draw the conclusion that, in present situation, introducing SB into residential side can take cost effect only in the condition that the electricity price for 12:00-15:00 period is higher than 206 JPY/kWh.

As shown in figure 7-4, when the initial cost of storage battery is 300,000JPY/kWh, the total electricity cost of residents is much higher than the cost of only using dynamic price. But as the decrease of storage battery's initial cost, the cost gap between case 2 and case 4 is narrowing. When the initial cost of battery reduced to 87% of the present price, reached at about



## CHAPTER SEVEN: ANALYSIS AND EVALUATION OF ELECTRICITY DYNAMIC PRICING IN BUILDINGS WITH DIFFERENT ENERGY SAVING TECHNOLOGIES

223,336JPY/kWh, the year electricity cost of case 2 that only using dynamic price and that of case 4 that using both dynamic price and storage battery are equivalent. If the initial cost of storage battery continued to decrease, using SB to eliminate extra fee caused by DP began to have feasibility.

As for the total electricity cost of residential house influenced by the import of photovoltaic, the results can be shown in figure 7-5. It is obvious that the total electricity cost of case 3 (equipped with photovoltaic) is lower than the cost of case 1 and case 2. Compared with case 2, the cost decrease ratio reached to 35.45% which proved that the introduction of photovoltaic is conducive to the reduction of residents' extra fee caused by using dynamic price. Introducing photovoltaic also can solve the contradiction between the improvement of whole grid and the residential consumers' benefit.

Figure 7-6 shows the income situation produced by photovoltaic. The amount is highly related to the value of solar radiation. In this part, the buy-back price of PV which be used in calculation is 38JPY/kWh.

## CHAPTER SEVEN: ANALYSIS AND EVALUATION OF ELECTRICITY DYNAMIC PRICING IN BUILDINGS WITH DIFFERENT ENERGY SAVING TECHNOLOGIES

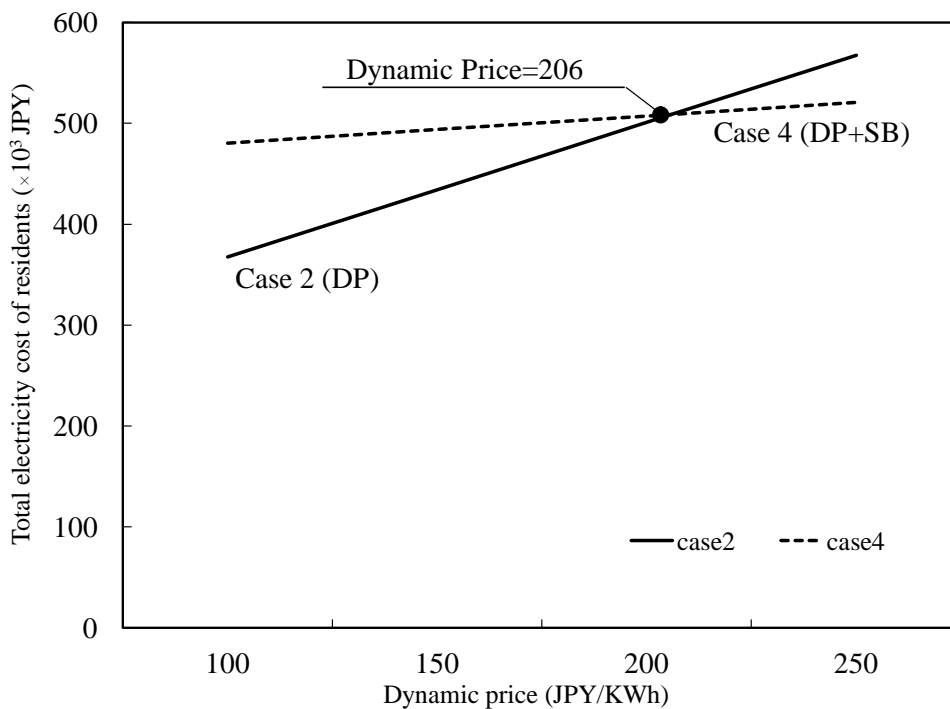

Figure 7-3 Total cost changes with the dynamic price

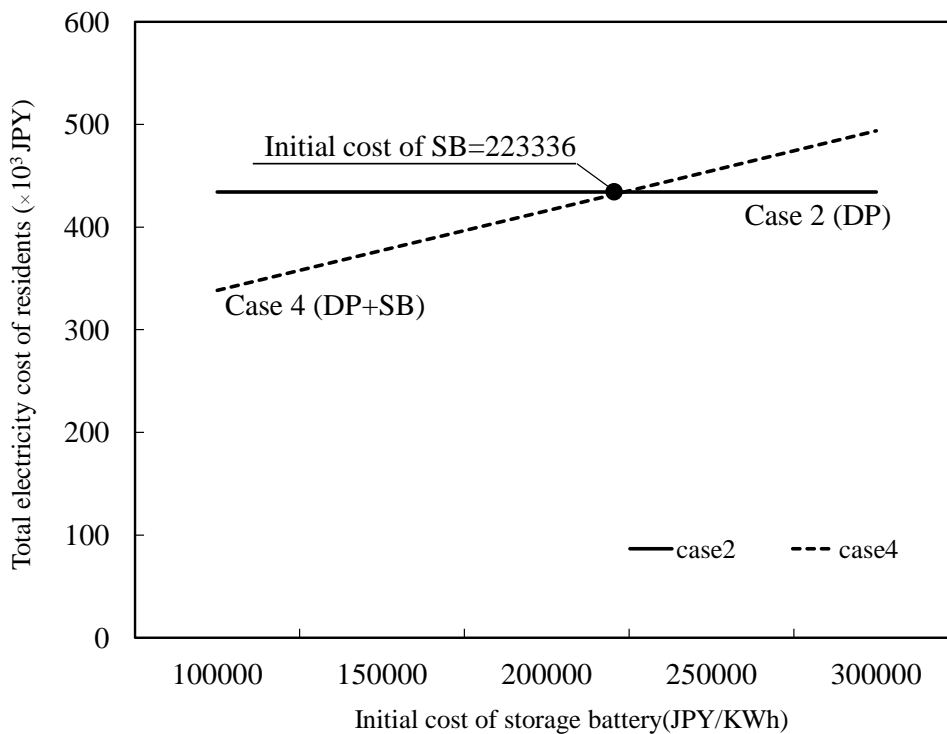

Figure 7-4 Total cost changes with the initial cost of battery

## CHAPTER SEVEN: ANALYSIS AND EVALUATION OF ELECTRICITY DYNAMIC PRICING IN BUILDINGS WITH DIFFERENT ENERGY SAVING TECHNOLOGIES

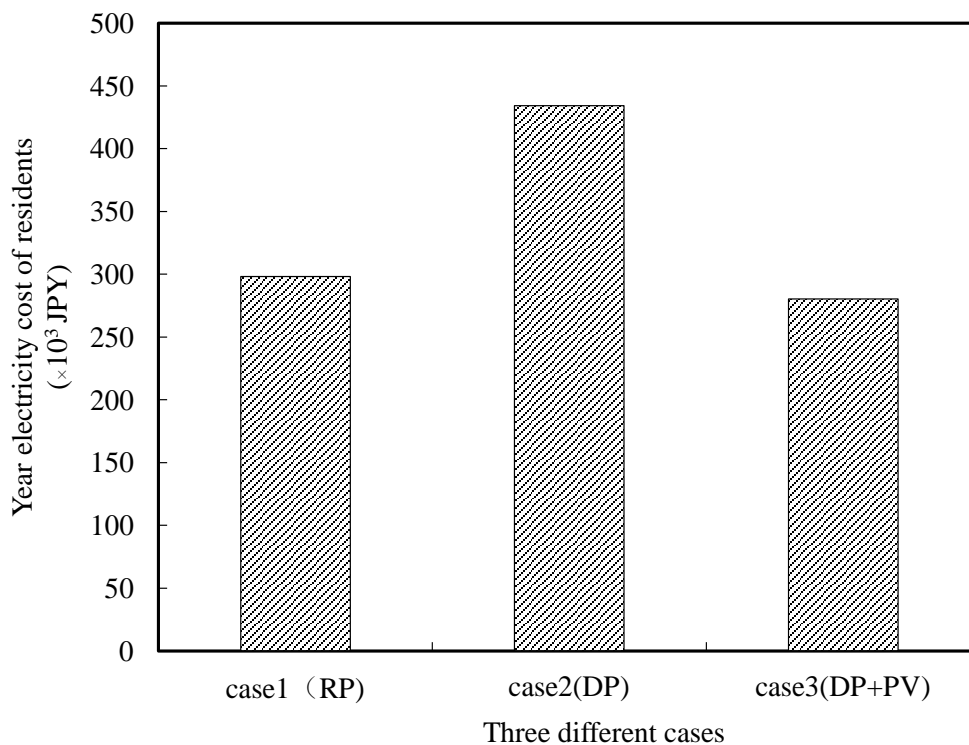

Figure 7-5 Total year electricity cost of different cases in residential house

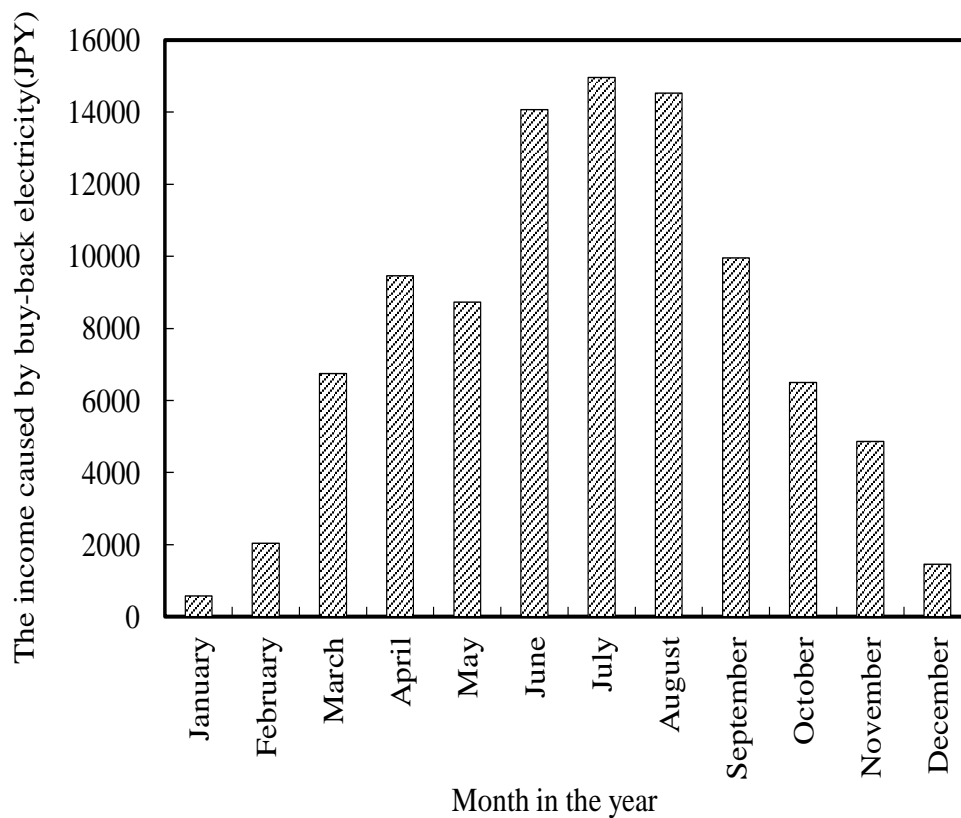

Figure 7-6 Profit of buy-back electricity powered by PV in residential house

## CHAPTER SEVEN: ANALYSIS AND EVALUATION OF ELECTRICITY DYNAMIC PRICING IN BUILDINGS WITH DIFFERENT ENERGY SAVING TECHNOLOGIES

Next, the effect of PV capacity and PV buy-back price on the cost performance in a residential house will be analyzed.

### (1) The effect of PV capacity on the cost performance in a residential house

Using the evaluation model, the changes in electricity year cost structure of PV equipped system was calculated. In this section, we assume that the capacity of the installed PV varies within the range of 3-8 kW, the estimated electricity purchase cost, initial investment of PV system and income of selling electricity can be shown in Fig. 7-7. It is obvious that the initial investment of PV system has a linear increase to the capacity. The cost of purchasing electricity from utility grid is decreased as the increase of PV capacity. In addition, when the capacity of PV reached 5 kW or more, the amount of decrease is very slightly. This is because of that the electricity purchase is mainly for the night use, and that time the influence of PV generation on self-use electricity can be almost neglected. What's more, looking into the figure, it can be found that the increase of PV capacity results in the increase of income of selling extra electricity back to the utility grid. It is owing to that when PV capacity reached some suitable value, the electricity of PV generation caused by capacity increase is mainly for sale. It is also can be seen from Fig. 8 that the electricity year cost is not always increased with the PV capacity increased. According to the component of electricity year cost, it is obvious that the initial investment of PV system is one important part of total year energy cost. The increase of PV capacity leads to the extremely increase of PV investment which results in that further increase of PV capacity is not helpful to increasing the electricity year cost saving ratio

### (2) The effect of PV buy-back price on the cost performance in a residential house

Due to the income of selling electricity is another essential part of electricity year cost, the effect of PV buy-back price on the cost performance also worth us to have a discussion. In this section, the capacity of PV is not the bigger the better as the change of buy-back price. From Fig.7-8, it can be obviously seen that when the buy-back price is 30JPY/kWh, the capacity of PV is the bigger the better. When the buy-back price was considered to reduce to 20 JPY/kWh, with the increase of PV's capacity, the year electricity cost of residents decreases firstly, and then starts to increase. When the buy-back price reached to 10 JPY/kWh, the year electricity cost of residents starts to increase with PV's capacity.

## CHAPTER SEVEN: ANALYSIS AND EVALUATION OF ELECTRICITY DYNAMIC PRICING IN BUILDINGS WITH DIFFERENT ENERGY SAVING TECHNOLOGIES

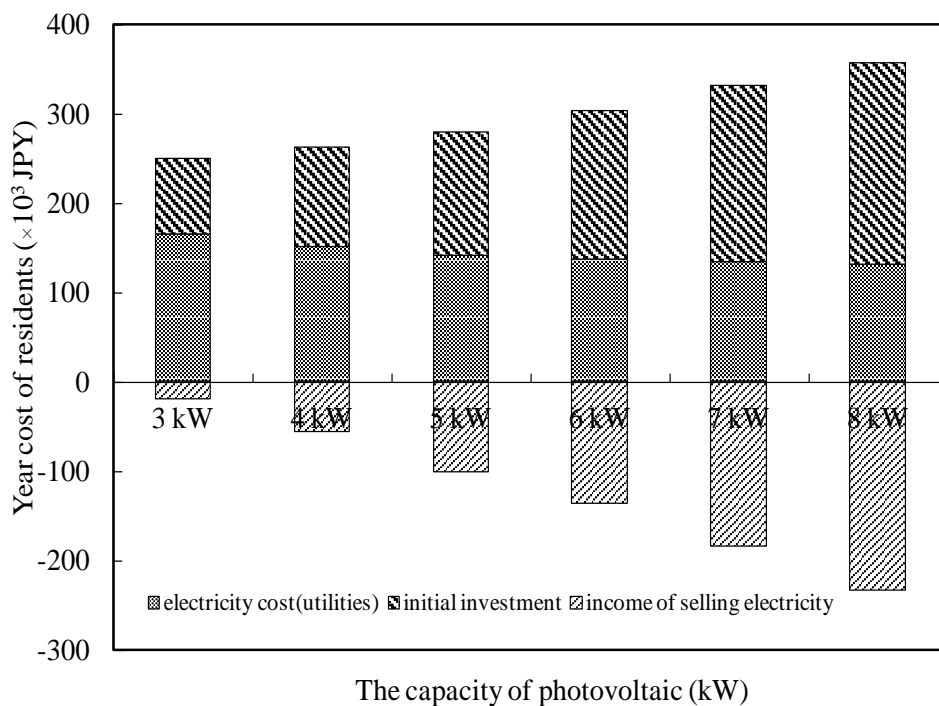

Figure 7-7 Component of electricity year cost of residents

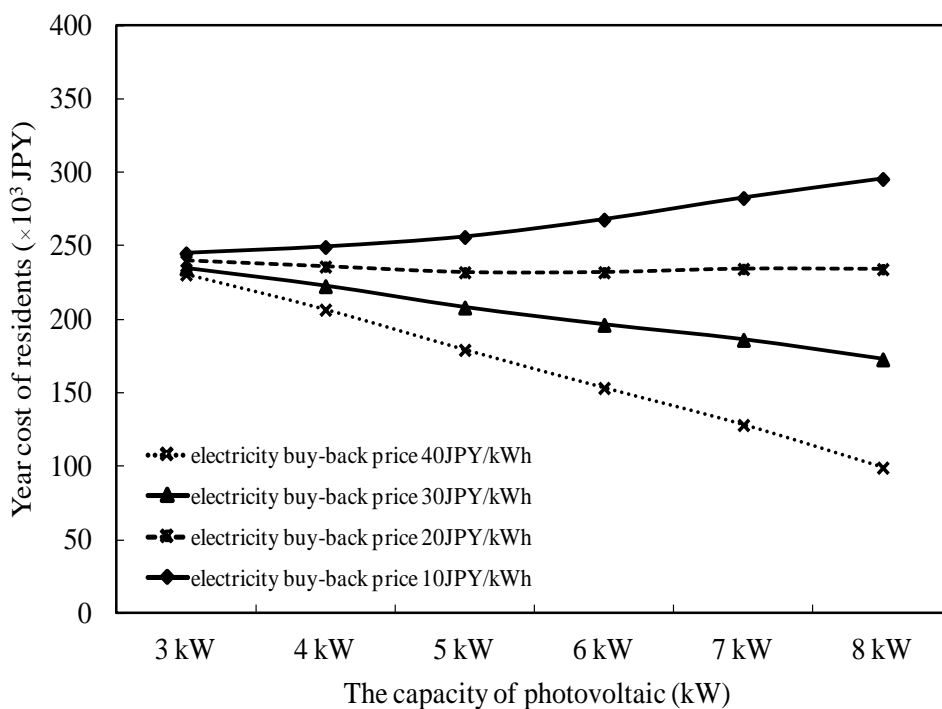

Figure 7-8 Effect of buy-back price on choosing capacity of PV

## CHAPTER SEVEN: ANALYSIS AND EVALUATION OF ELECTRICITY DYNAMIC PRICING IN BUILDINGS WITH DIFFERENT ENERGY SAVING TECHNOLOGIES

### 7.4 Case study 2- Analysis and evaluation of DP in Hospital

#### 7.4.1 Case setting

Five different ways were planned for the hospital case study. The case settings were shown in table 7-5. The capacity of storage battery in case 4 and case 5 are 2,000 kWh and 1,000 kWh, respectively. The capacity of photovoltaic is 1200 kW in both case 3 and case 5. Here, as same as residential house, we let case 1 only use the regular price. Case 2 use the dynamic price. Both case 1 and case 2 are not equips with storage battery or photovoltaic. Case 3, case 4, and case 5, they are all using the dynamic price, meanwhile, photovoltaic was introduced into case 3, storage battery was introduced into case 4, case 5 was equipped with both storage battery and photovoltaic. Through the comparison among these cases, we can get the conclusion that which device combination is the best choice for hospital consumers.

In a general way, hospital has its own operating characteristic. In order to meet patients' hospitalizing time, it is not possible for hospital to shift peak load to other period. So the effect of introducing energy saving technologies on the cost performance of hospital which using dynamic price is necessary to be investigated.

Table 7-5 Five different cases for hospital

	Electricity mode	Storage battery	Photovoltaic
Case 1	Regular price	Not have	Not have
Case 2	Dynamic price	Not have	Not have
Case 3	Dynamic price	Not have	have
Case 4	Dynamic price	have	Not have
Case 5	Dynamic price	have	have

#### 7.4.2 Analysis results and discussion

Figure 7-9 is the year electricity cost of different cases in hospital. It is obvious that whether introduced storage battery or photovoltaic into hospital side can take effect on eliminating extra fee caused by using dynamic price. We can see that the electricity cost of case 5 which was equipped with storage battery and photovoltaic is far lower than that of other cases. As for Case 5, the electricity demand of hospital supplied by photovoltaic priority, after that, the electricity provided by storage battery to a certain extent. The extra part provided by utility grid.

As figure 7-9 shown, the electricity cost of case 4 and case 5 are almost the similar. The electricity cost of case 3 which equipped with photovoltaic is higher than the cost of case 4 which equipped with storage battery, and it is also higher than the cost of case 1 which only using RP. The reason can be summarized as follows. First, according to figure 7-10, we can see that the gap between the consumption of electricity and generating capacity of PV is enormous. According to the limitation of roof area, the maximal generating capacity of PV is almost 27 thousand kW, while the maximum of hospital's month electricity consumption almost reached at the 18 million kW. It is obvious that the generation of PV is not sufficient to meet such a high electricity consumption of hospital. So the effect of introducing PV into hospital is not obvious as the effect of introducing storage battery into hospital

## CHAPTER SEVEN: ANALYSIS AND EVALUATION OF ELECTRICITY DYNAMIC PRICING IN BUILDINGS WITH DIFFERENT ENERGY SAVING TECHNOLOGIES

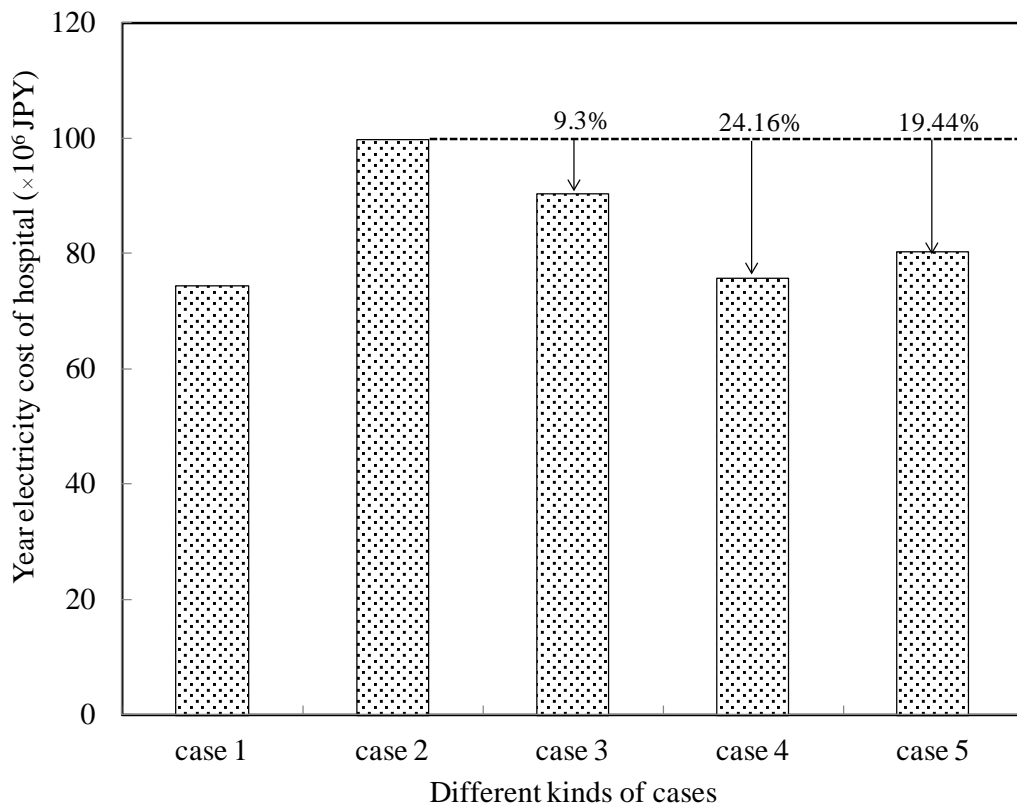

Figure 7-9 Total year electricity cost of five cases in hospital

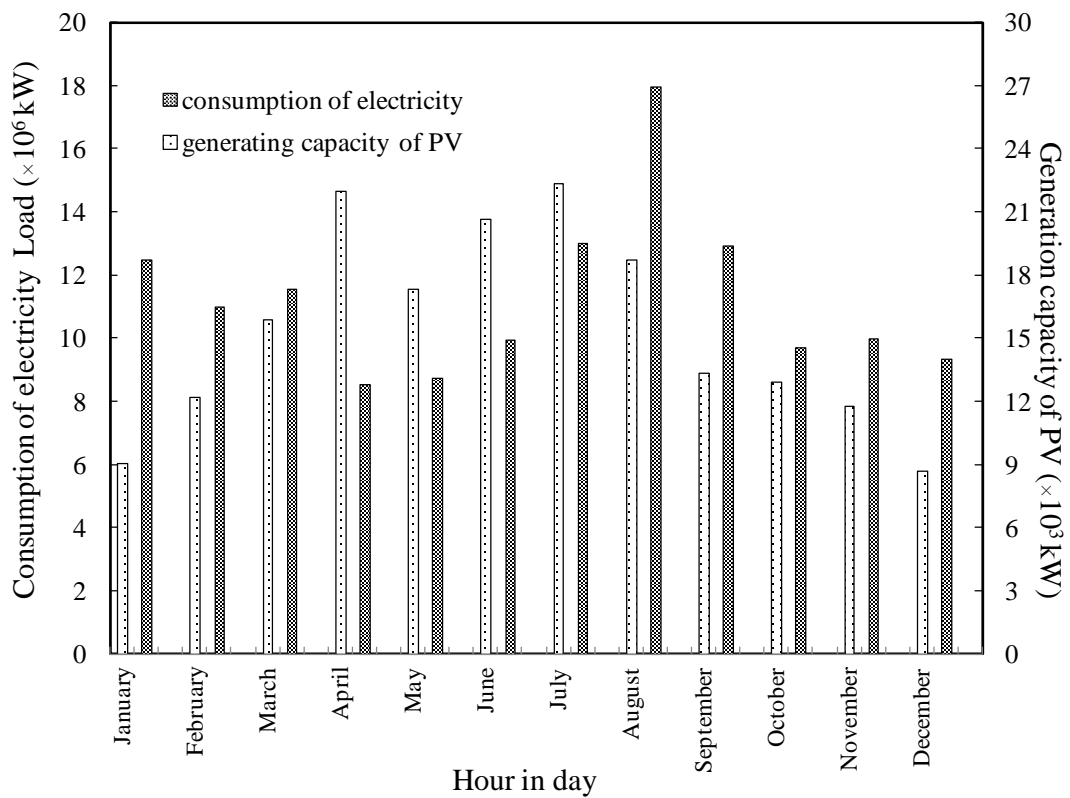

Figure 7-10 Electricity consumption and PV generation of in hospital

## CHAPTER SEVEN: ANALYSIS AND EVALUATION OF ELECTRICITY DYNAMIC PRICING IN BUILDINGS WITH DIFFERENT ENERGY SAVING TECHNOLOGIES

Figure 7-11 is the comparison result of carbon dioxide emission between different cases. Case 3 which installed with PV is the most environmentally choice compared to other options. In addition, the CO<sub>2</sub> emission of case 5 is lower than case 4 which owing to that solar energy is a kind of clean energy. Therefore, if taking both figure 6-46 and figure 6-48 into consideration, case 5 is the best

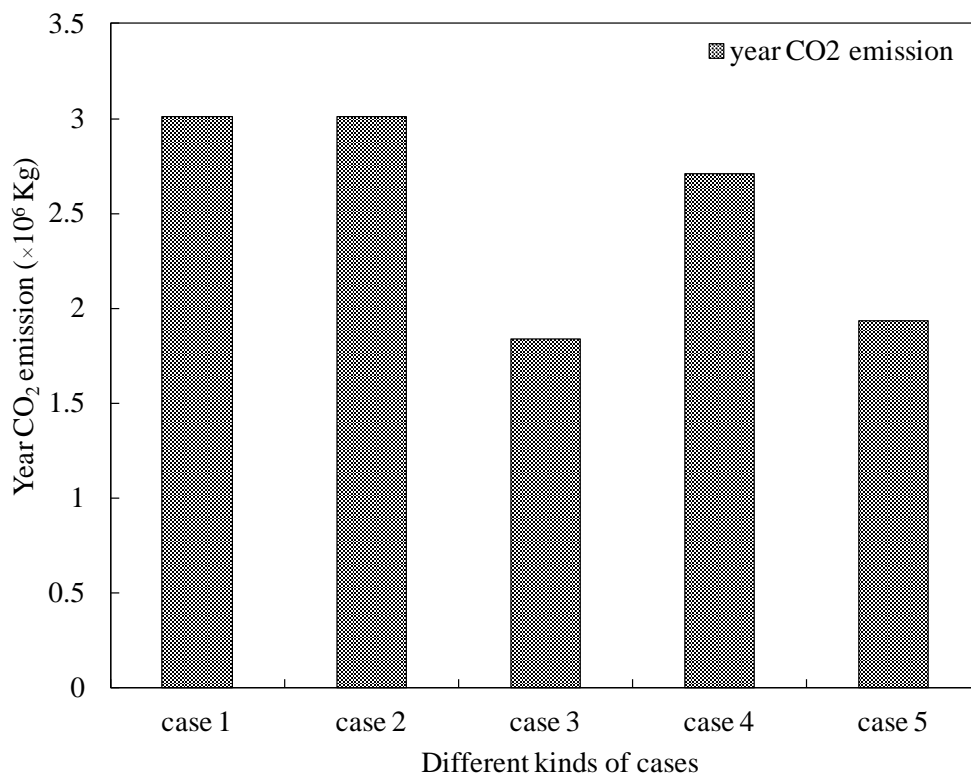

Figure 7-11 Total year CO<sub>2</sub> emissions of five cases in hospital

choice for hospital caused it combined economic effect and environment protection

This section explored the effects of storage battery and photovoltaic technology on the cost performance in a hospital which equipped with dynamic pricing. It is obvious that whether introducing storage battery or photovoltaic into hospital can solve the contradiction between the improvement of whole grid and the hospital consumers' benefit. Compared to consumers that using dynamic price without equipped with any device, the year cost reduction ratio for storage battery is 24.16%, for photovoltaic is 9.3%. If both storage battery and photovoltaic were introduced into the hospital, the year cost ratio can reach at 19.44%.

If taking consideration of economic effect as the main target, equipped with storage battery is the best choice for hospital consumers. If environmental items were mainly considered, the option of introducing photovoltaic is better than other options. If economic and environmental effect were all taking into the consideration, introducing both storage battery and photovoltaic is a good choice.

Actually, the economic effect of different cases is tightly related to the capacity of devices. Different capacity will lead to different effects. In the following section, the year electricity cost affected by capacity of PV or SB will be discussed.



**CHAPTER SEVEN: ANALYSIS AND EVALUATION OF ELECTRICITY DYNAMIC PRICING IN BUILDINGS WITH DIFFERENT ENERGY SAVING TECHNOLOGIES**

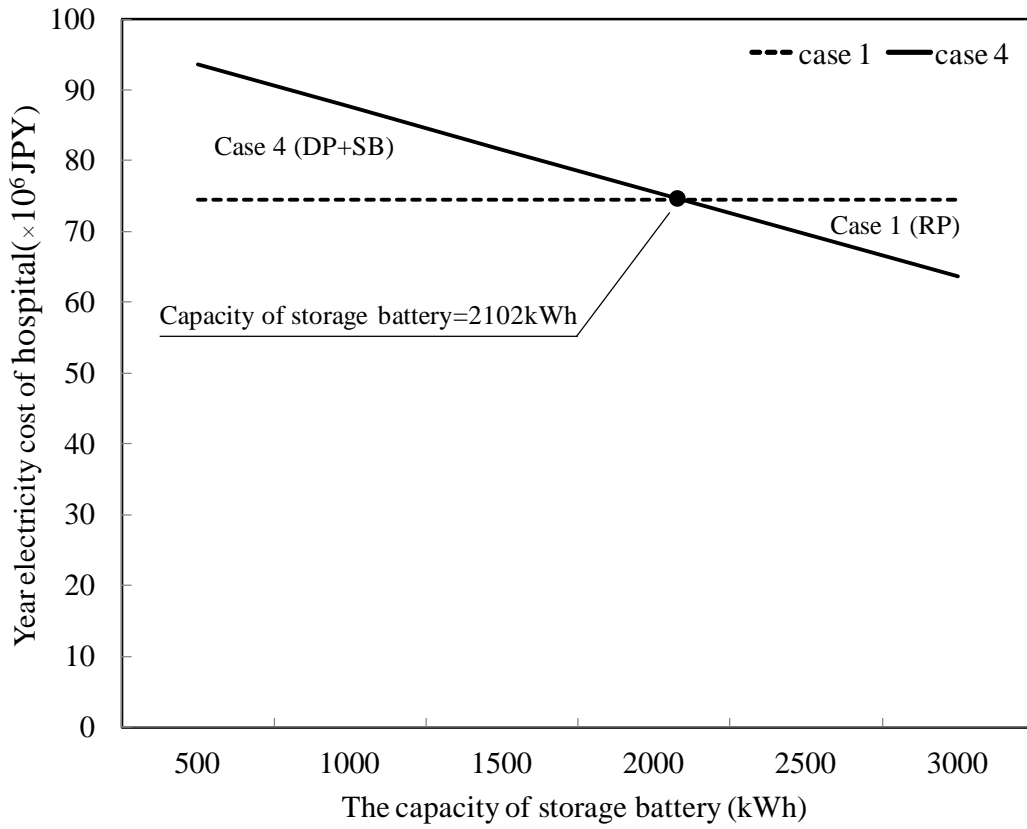

Figure 7-12 Effect of SB's capacity on the cost performance in hospital

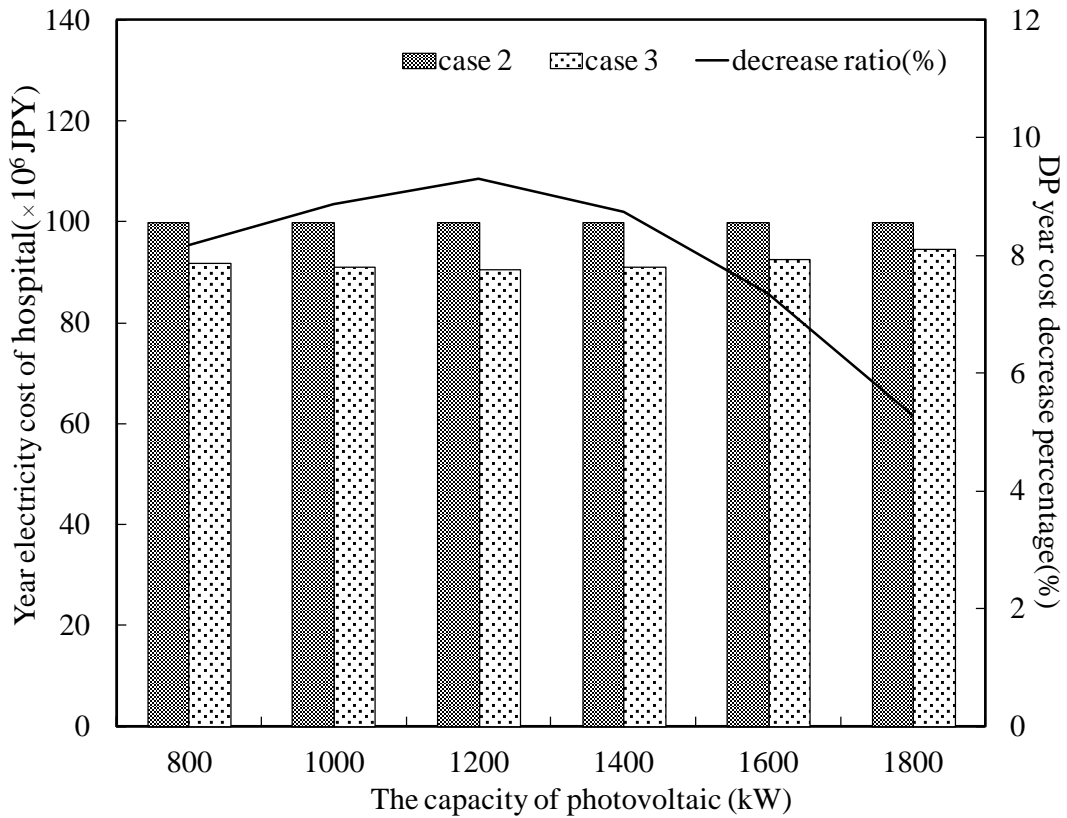

Figure 7-13 Effect of PV capacity on the cost performance in hospital

## CHAPTER SEVEN: ANALYSIS AND EVALUATION OF ELECTRICITY DYNAMIC PRICING IN BUILDINGS WITH DIFFERENT ENERGY SAVING TECHNOLOGIES

As for the introduction of SB, in order to investigate the year electricity cost of hospital affected by its capacity, we make an assumption that the capacity of SB is changed in the range from 500kWh to 3000kWh to see its cost performance. According to figure 7-12, we can know that the cost of case 4 was decreased as the increase of capacity of SB. In addition, if the hospital has installed with SB which capacity reached at 2102kWh, introducing SB into hospital side starts to take economic effect in respect of reducing the electricity cost of DP.

As for the introduction of PV, we make an assumption that the capacity of PV is changed in the range from 800kW to 1800kW to see its cost performance in hospital. From figure 7-13, we can know that the cost of case 3 which uses DP and PV is a bit lower than that of case 2 which uses DP only. The reason is that, in peak period, as same situation as case 4, the hospital consumers of case 3 can use electricity generated by PV instead of using electricity from utility grid, saved the electricity cost caused by using high peak tariff in DP system. Figure 7-13 also shows that when the capacity of PV reached 1200 kW, the decrease ratio is the maximum.

In addition, owing to the high initial cost of PV restricts its cost decrease effect, the capacity of PV is not the bigger the better and an optimal value exists. As shown in figure 7-14, the initial investment of PV system has a linear increase to its capacity. Although the electricity cost of case 3 is decreased as the increase of PV's capacity, this reduce pace is not as fast as the growth rate of PV's initial investment.

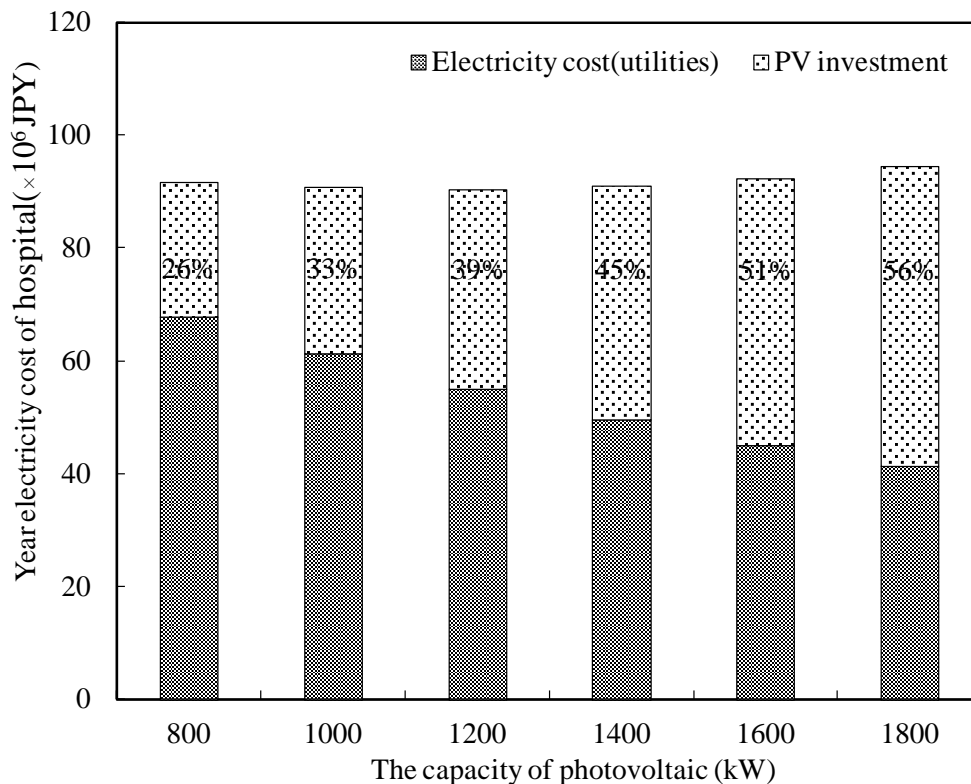

Figure 7-14 Component of year electricity cost of hospital

## CHAPTER SEVEN: ANALYSIS AND EVALUATION OF ELECTRICITY DYNAMIC PRICING IN BUILDINGS WITH DIFFERENT ENERGY SAVING TECHNOLOGIES

### 7.5 Case study 3- Analysis and evaluation of DP in office

#### 7.5.1 Case setting

In office house, the case setting is similar with that in hospital. Five different cases were supposed to investigate the effect of introducing SB and PV. In peak period, consumers can use the electricity from SB or PV to take place of using electricity from utility grid. Through this way, the extra cost produced by using DP can be avoided. Here, the capacity of storage battery in case 4 and case 5 are 500 kWh and 400 kWh respectively. The capacity of photovoltaic is 150 kW in both case 3 and case 5.

#### 7.5.2 Analysis results and discussion

According to figure 7-15, we can know that case 5 which equipped with both SB and PV is the most cost effective one, reduction ratio of year electricity cost almost reached to 25.31%. In addition, Fig.7-16 is the comparison result of carbon dioxide emission between different cases in an office.

Besides, we also have discussed economic effect affected by capacity of two devices respectively.

In this section, we make the capacity of SB changed in the range from 100kWh to 600kWh to investigate its cost performance in office. As figure 7-17 shown, we can know that if the office has installed with SB which capacity reached at 612 kWh, the year cost of case 4 is equivalent with that of case 1. If the capacity continued to increase, the cost of case 4 will lower than case 1, introducing SB start to have its economic effect.

Figure 7-18 is year electricity cost of office affected by the capacity of PV. It can be see that he introduction of PV also can take cost saving effect (the cost of case 3 is between case 1 and case 2). Furthermore, the capacity of PV is not the bigger the better, when the capacity of PV is higher than 500kW, the electricity cost will increase again.

**CHAPTER SEVEN: ANALYSIS AND EVALUATION OF ELECTRICITY  
DYNAMIC PRICING IN BUILDINGS WITH DIFFERENT ENERGY SAVING  
TECHNOLOGIES**

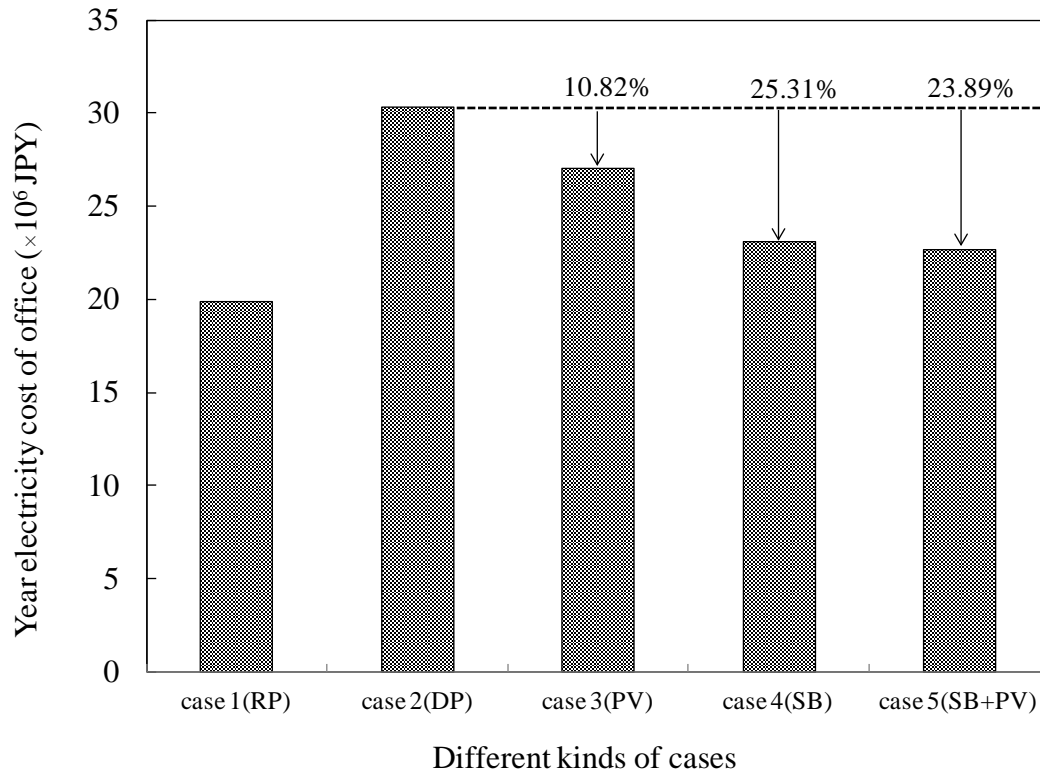

Figure 7-15 Total year electricity cost of five cases in office

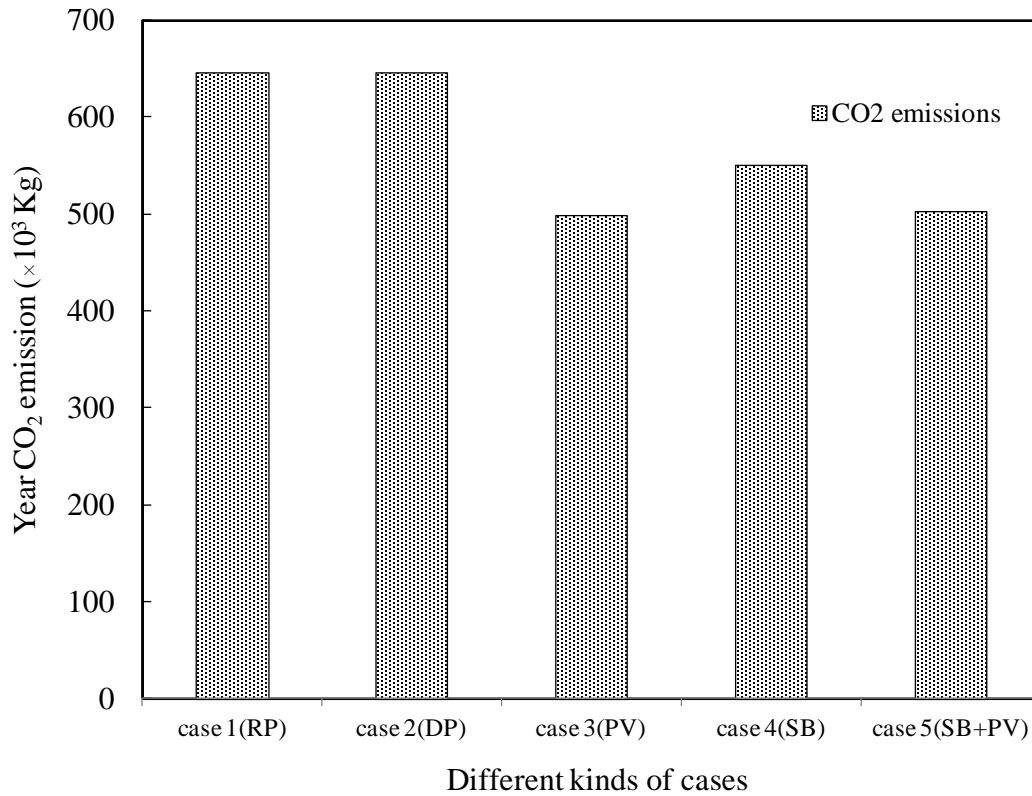

Figure 7-16 Total year CO<sub>2</sub> emissions of five cases in office

**CHAPTER SEVEN: ANALYSIS AND EVALUATION OF ELECTRICITY DYNAMIC PRICING IN BUILDINGS WITH DIFFERENT ENERGY SAVING TECHNOLOGIES**

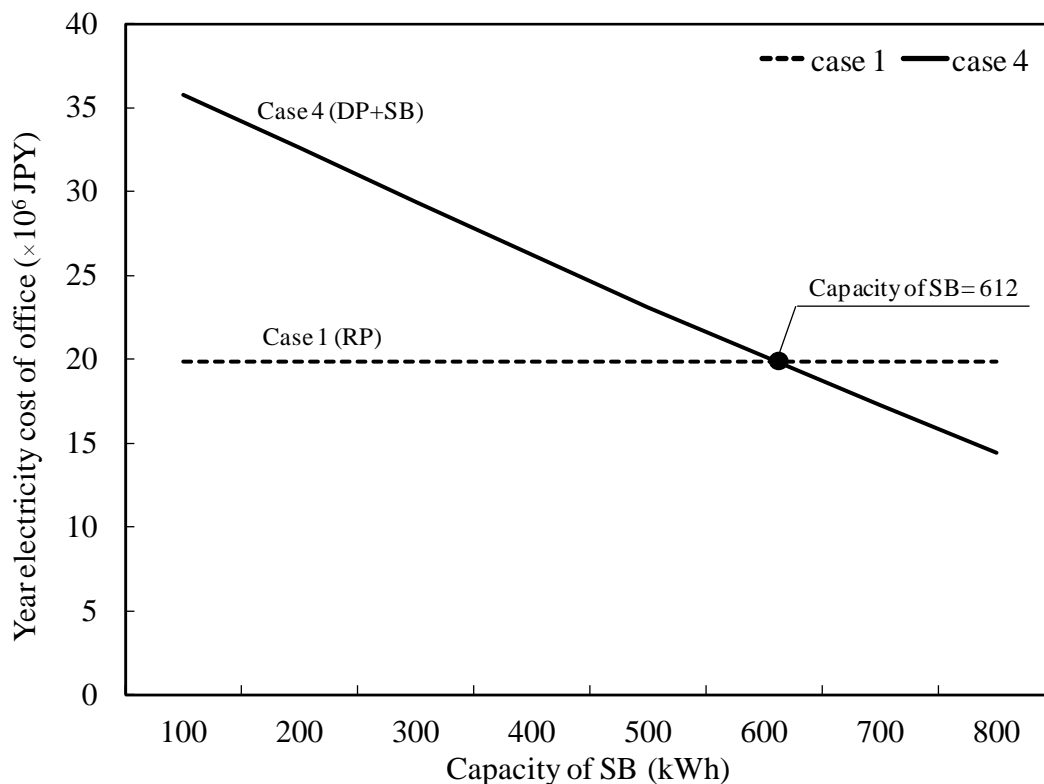

Figure 7-17 Year electricity cost of office affected by the capacity of SB

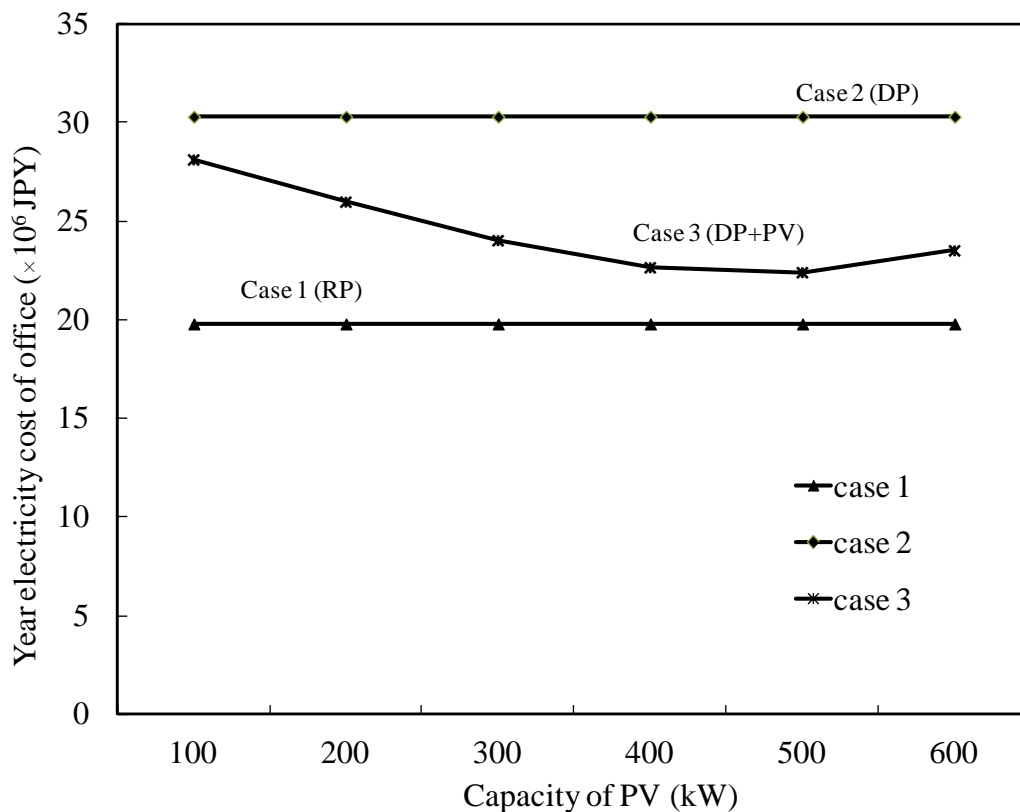

Figure 7-18 Year electricity cost of office affected by the capacity of PV

## CHAPTER SEVEN: ANALYSIS AND EVALUATION OF ELECTRICITY DYNAMIC PRICING IN BUILDINGS WITH DIFFERENT ENERGY SAVING TECHNOLOGIES

### 7.6 Case study 4- Analysis and evaluation of DP in hotel

#### 7.6.1 Case setting

The case setting of hotel is as same as hospital. In this section, the capacity of storage battery in case 4 and case 5 are 2000 kWh and 1000 kWh respectively. The capacity of photovoltaic is 1200 kW in both case 3 and case 5.

#### 7.6.2 Analysis results and discussion

According to figure 7-19, we can know that whether introducing SB or PV into hotel, it can take the cost saving effect. The figure also tells us that case 4 which only equipped with SB can realize the maximum cost reduction. Figure 7-20 is the total year CO<sub>2</sub> emissions of five cases in hotel. Here, case 3 which installed with PV is the most environmentally choice compared to other options. The reason is that PV use solar energy to generate electricity instead of fossil fuel, it release no carbon dioxide, and don't contribute to global warming. Using the same analysis method with hospital, the year electricity cost affected by capacity of PV or SB in hotel will be discussed in the following section. Figure 7-21 shows the effect of SB's capacity on the cost performance in a hotel. Similar to hospital, it can be seen that if the capacity of SB is higher than 2184 kWh, the year electricity cost of case 4 will lower than the cost of case 1. Figure 7-22 shows the effect of PV's capacity on the cost performance in a hotel. It is obvious that when the capacity of PV reached at 1200kWh, the cost decrease ratio of case 2 reached at maximum. Figure 7-23 shows the component of year electricity cost of hotel. It composed of utility electricity cost and the investment of PV. As shown in this figure, the investment is increased as the increase of the capacity of PV as anticipated. Besides, the year electricity cost is decreased as the increase of capacity. The increased ratio of investment is faster than the decrease ratio of year electricity cost.

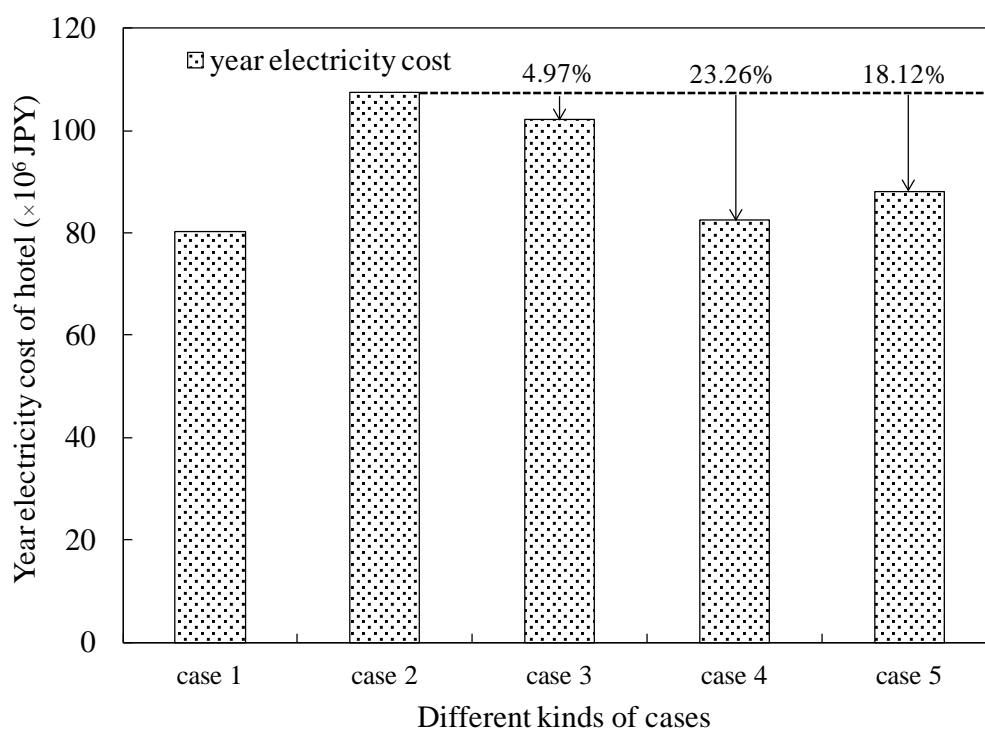

Figure 7-19 Total year electricity cost of five cases in hotel

Therefore, the optimal capacity of PV is 1200 kW.

**CHAPTER SEVEN: ANALYSIS AND EVALUATION OF ELECTRICITY  
DYNAMIC PRICING IN BUILDINGS WITH DIFFERENT ENERGY SAVING  
TECHNOLOGIES**

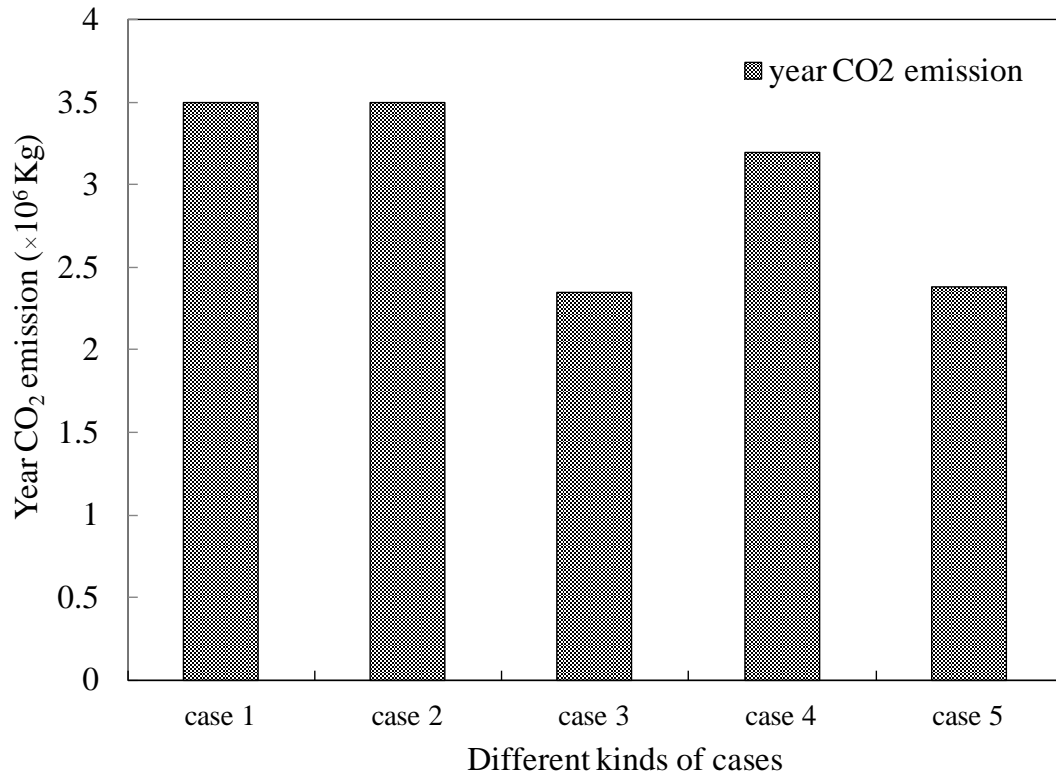

Figure 7-20 Total year CO<sub>2</sub> emissions of five cases in hotel

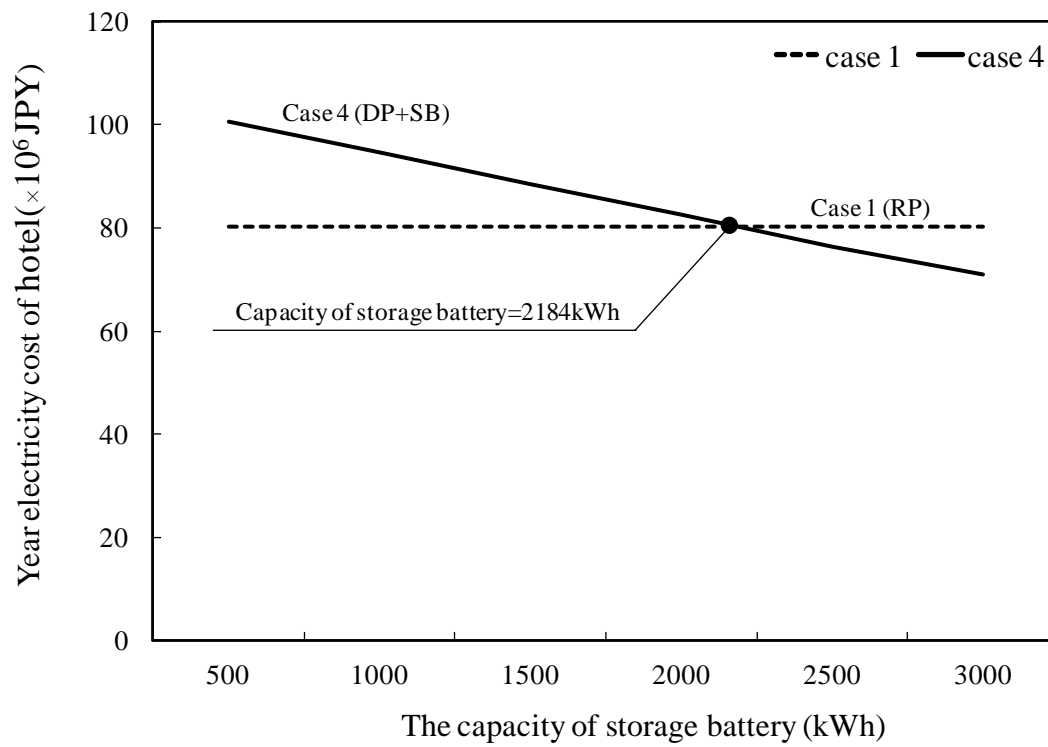

Figure 7-21 The effect of SB's capacity on the cost performance in a hotel

**CHAPTER SEVEN: ANALYSIS AND EVALUATION OF ELECTRICITY  
DYNAMIC PRICING IN BUILDINGS WITH DIFFERENT ENERGY SAVING  
TECHNOLOGIES**

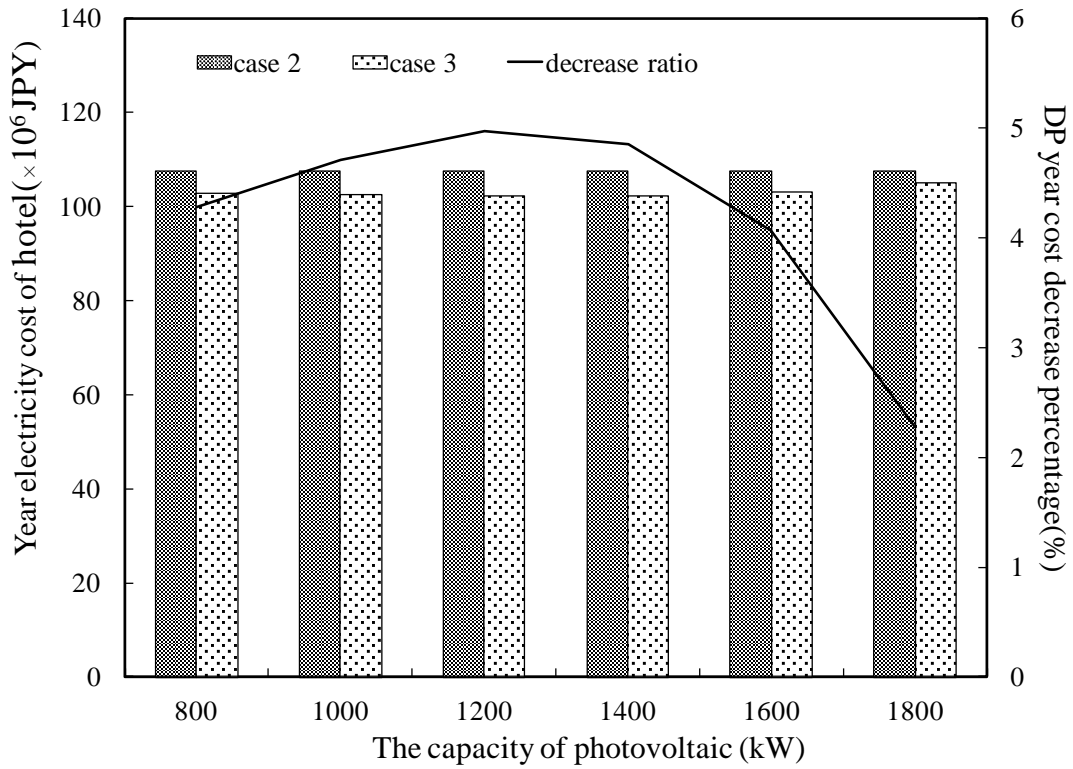

Figure 7-22 The effect of PV's capacity on the cost performance in a hotel

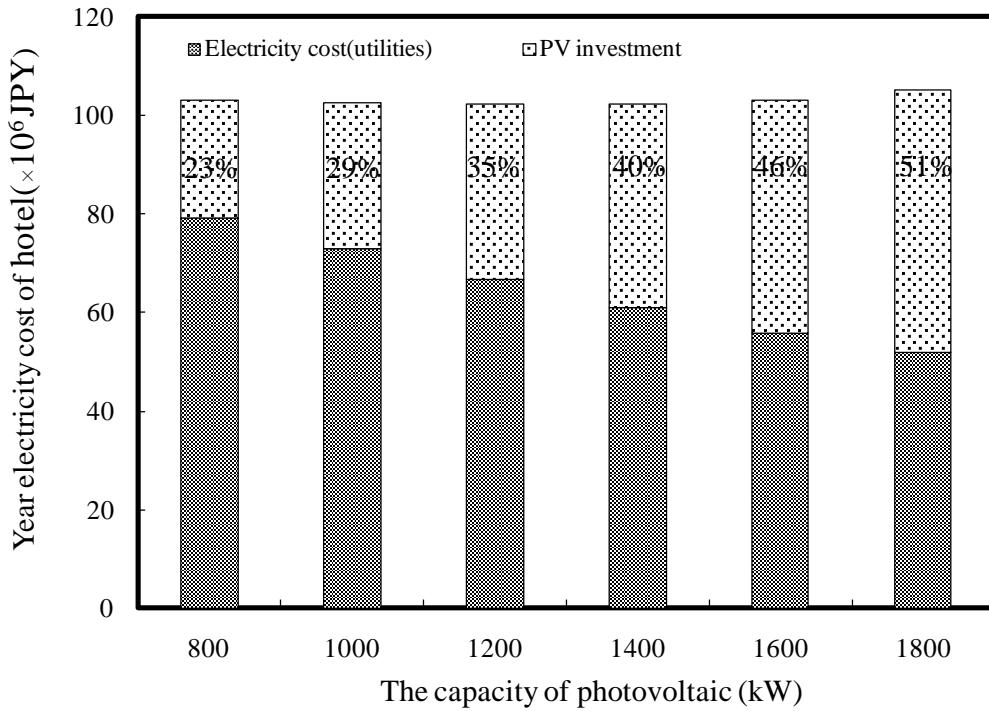

Figure 7-23 Component of year electricity cost of hotel



## CHAPTER SEVEN: ANALYSIS AND EVALUATION OF ELECTRICITY DYNAMIC PRICING IN BUILDINGS WITH DIFFERENT ENERGY SAVING TECHNOLOGIES

### 7.7 Case study 5- Analysis and evaluation of DP in area

#### 7.7.1 Case setting

As for the area, it holds the large load value and complex load characteristics owing to it contains different types of buildings. In order to analyze the optimal options for planning distributed generation system and heat source technologies in an area, this paper plans four cases in order to realize different objectives. The case setting information is explained as shown in table 7-6.

Table 7-6 Different cases for the area

Cases	Description
Case 0	Basic case which is the system that does not introduce the distributed power technology.
Case 1	Energy saving performance optimal case which is the system with the maximum annual primary energy consumption reduction rate.
Case 2	Economy performance optimal case which is the system with the maximum annual cost reduction rate
Case 3	Environment performance optimal case which is the system with the maximum annual CO <sub>2</sub> emissions reduction rate.

◇ Related database

#### (1) Technical information

Through the catalogue of manufacturers, the capacity, efficiency and initial cost of each facility were collected, and the database of distributed power and heat source technology was constructed as what is shown in table 7-7 and table 7-8. In the same distributed power technology, power generation efficiency and the recovery efficiency of exhaust heat are changing according to the capacity. Regarding the facilities, like waste heat recovery absorption refrigerator (ABS) and heat pump (HP) which can supply not only cooling load but also heating load, this paper sets different capacity for supplying cooling-heating and the performance coefficient.

Table 7-7 Database of generating facilities

Powering facilities	Capacity (kW)	Powering efficiency	Heat recovery rate	Initial investment (10 <sup>4</sup> yen)
GE-1	100	0.3	0.48	2000
GE-2	150	0.31	0.47	2925
GE-3	200	0.32	0.46	3800
GE-4	250	0.33	0.45	4625
GE-5	300	0.34	0.44	5400
GE-6	350	0.35	0.43	6125
GE-7	400	0.36	0.42	6800
FC-1	100	0.38	0.36	8000
FC-2	150	0.39	0.35	11625
FC-3	200	0.4	0.34	15000
FC-4	250	0.41	0.33	18125
FC-5	300	0.42	0.32	21000

**CHAPTER SEVEN: ANALYSIS AND EVALUATION OF ELECTRICITY  
DYNAMIC PRICING IN BUILDINGS WITH DIFFERENT ENERGY SAVING  
TECHNOLOGIES**

FC-6	350	0.43	0.31	23625
FC-7	400	0.44	0.3	26000
PV-1	50	-	-	3000
PV-2	100	-	-	6000
PV-3	150	-	-	9000
PV-4	200	-	-	12000

Table 7-8 Database of heating facilities

Heating facilities	Supply capability (kW)		COP		Initial investment (10 <sup>4</sup> yen)
	Cooling	Heating	Cooling	Heating	
ABS-1	400	260	1.45	0.88	1920
ABS-2	450	300	1.45	0.88	2160
ABS-3	500	330	1.45	0.88	2400
ABS-4	550	360	1.45	0.88	2580
ABS-5	600	400	1.45	0.88	2800
ABS-6	650	430	1.45	0.88	2920
ABS-7	700	460	1.45	0.88	3100
HP -1	200	300	2.8	3.7	800
HP -2	250	375	2.8	3.7	975
HP -3	300	450	2.8	3.7	1155
HP -4	350	525	2.8	3.7	1310
HP -5	400	600	2.8	3.7	1480
HP -6	450	675	2.8	3.7	1640
HP -7	500	750	2.8	3.7	1800
TC -1	800	-	6	-	3000
TC -2	850	-	6	-	3100
TC -3	900	-	6	-	3200
GB -1	-	50	-	0.9	150
GB -2	-	100	-	0.9	280
GB -3	-	150	-	0.9	390
GB -4	-	200	-	0.9	500
HE -1	-	100	-	0.8	60
HE -2	-	200	-	0.8	120
HE -3	-	300	-	0.8	180
HE -4	-	400	-	0.8	240
HE -5	-	500	-	0.8	300
HE -6	-	600	-	0.8	360

## CHAPTER SEVEN: ANALYSIS AND EVALUATION OF ELECTRICITY DYNAMIC PRICING IN BUILDINGS WITH DIFFERENT ENERGY SAVING TECHNOLOGIES

### (2) Electricity load of the area

Here, the area load was calculated according to the unit primary energy consumption issued by Kyushu area. In order to see the load characteristics, the load curves in winter (January) and summer (August) are shown in figure 7-24 and figure 7-25. It is obvious that the changes in hourly air conditioning load and electricity load are intense, and supply peaks of heat and electric power occur at substantially the same time zone.

### 7.7.2 Analysis results and discussion

Table 7-9 and table 7-10 show the calculation results of DER system in different cases for the area.

In the case 1, the annual primary energy consumption of DER system decreases by a high percentage of 31.23%, but the annual cost increases by a ratio of 19.95%. What's more, the annual CO<sub>2</sub> emissions decreases by a high ratio of 45.68% compared with the CES. It is clear that with the introduction of fuel cell and photovoltaic facilities, the energy saving performance can be improved very effectively, however, the economical cost reduce ratio shows the different trends with the primary energy consumption reduce ratio and there is no economy performance in this case due to the high initial cost of DER system.

In the case 2, the gas engine becomes the optimal power generation facility on economy performance, the annual primary energy consumption decreases by 20.04%, the annual cost also decreased by a percentage of 13.8%, and the annual CO<sub>2</sub> emissions decreases by a ratio of 35.94%.

The configuration of facilities and each reduction rate in case 3 are almost the same with case 1. The two cases hold both high energy saving performance and environmental performance. It was understood that the reduction of energy consumption make a huge influence on the decrease of environment performance load. In addition, the high primary energy consumption reduce ratio and high CO<sub>2</sub> emission reduce ratio always not mean the good economy performance.

Table 7-9 Reduction ratio of DER system in different cases

	Total primary energy consumption (GJ)	Total economical cost (10 <sup>4</sup> yen)	Total CO <sub>2</sub> emission (t)	Primary energy consumption reduce ratio (%)	Economical cost reduce ratio (%)	CO <sub>2</sub> emission reduce ratio (%)
case 0	52836.24	10045.56	3285.32			
case 1	36345.19	12050.30	1784.50	31.23	-19.95	45.68
case 2	42246.75	8658.78	2104.60	20.04	13.8	35.94
case 3	36347.18	11819.80	1783.43	31.20	-17.66	45.72

Figure 7-26 shows the composition of annual primary energy consumption of each case. The annual primary energy consumption includes primary energy consumption of power generation facilities, primary energy consumption of heating facilities and primary energy consumption of grid power. In Case 1 which emphasizes reaching the maximum energy conservation, power generation facility that with high overall efficiency accounts for the large percentage, therefore, realize the largest primary energy consumption reduction ratio. As for case 2 which is economy performance optimal case that the system with the maximum annual cost reduction rate, the initial

**CHAPTER SEVEN: ANALYSIS AND EVALUATION OF ELECTRICITY  
DYNAMIC PRICING IN BUILDINGS WITH DIFFERENT ENERGY SAVING  
TECHNOLOGIES**

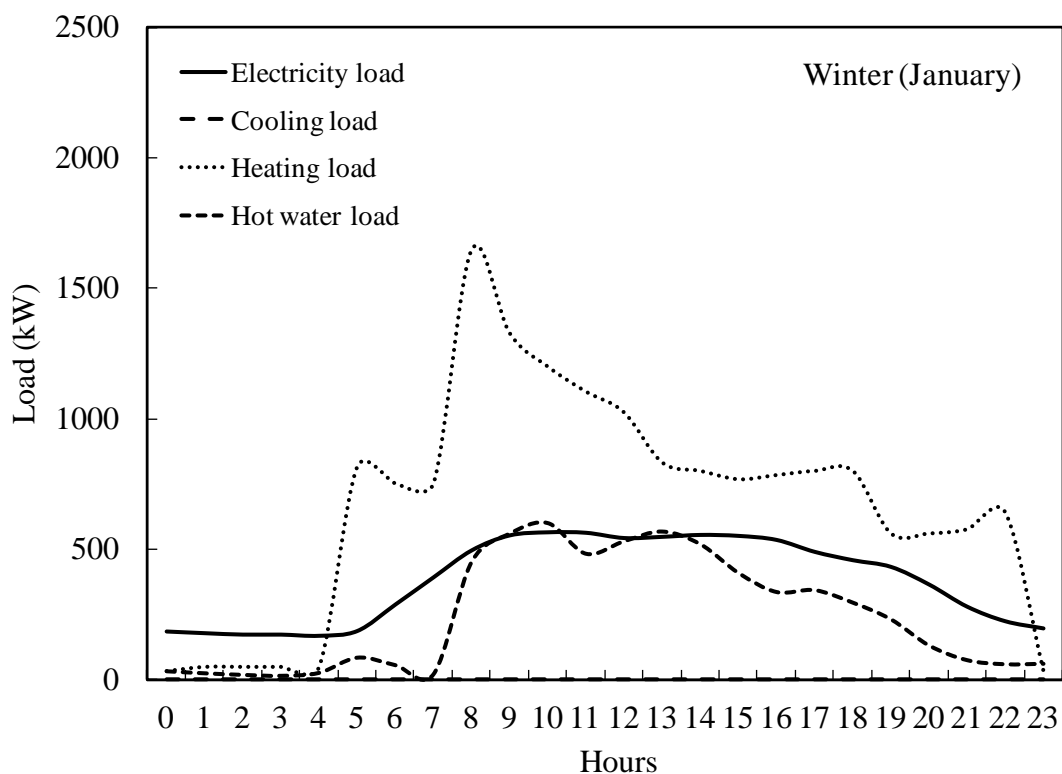

Figure 7-24 Average hourly load in winter (January)

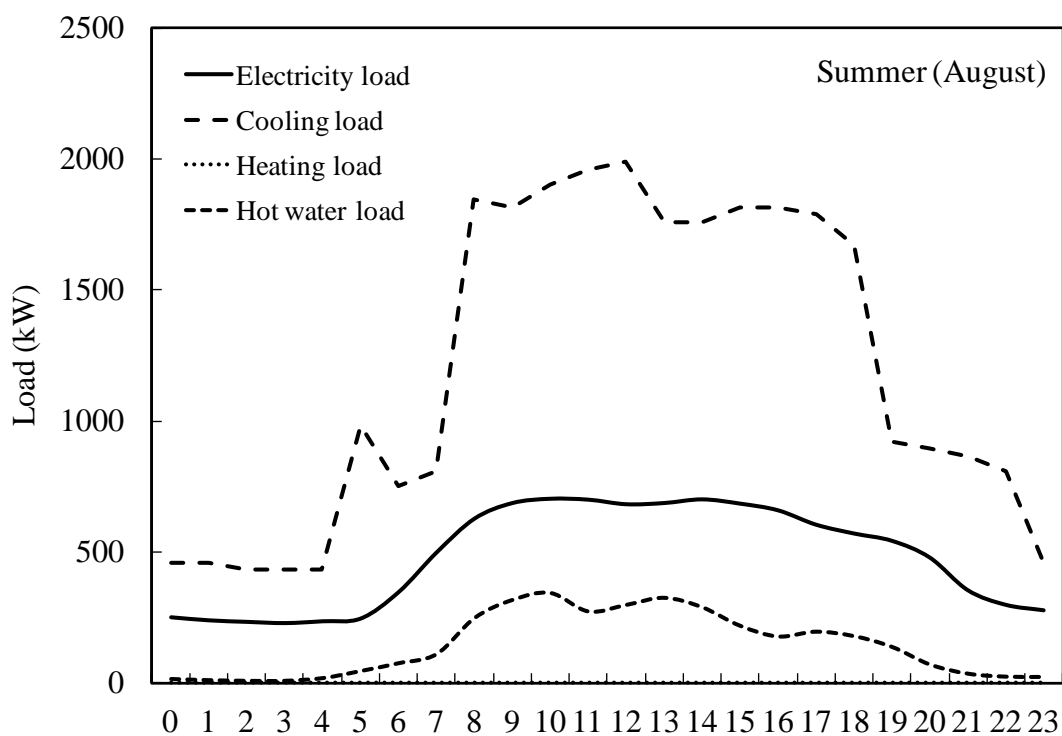

Figure 7-25 Average hourly load in summer (August)

## CHAPTER SEVEN: ANALYSIS AND EVALUATION OF ELECTRICITY DYNAMIC PRICING IN BUILDINGS WITH DIFFERENT ENERGY SAVING TECHNOLOGIES

Table 7-10 Optimal selection of facilities in DER system

	Generation facilities (Numbers)	Heating facilities (Numbers)
Case 0	-	ABS -7(4); GB-4(4)
Case 1	GE-5(1);GE-7(1);FC-7(1);PV-4(2)	ABS-7(1);GB-4(1);HP-7(2);TC-3(2);HE-6(1)
Case 2	GE-7(2);	ABS-2(1);ABS-7(1);GB-4(1);HP-7(1);TC-1(1);HE-5(1)
Case 3	GE-5(1);GE-7(1);FC-7(1);PV-4(2)	ABS-7(1);GB-4(1);HP-7(2);TC-3(2);HE-5(1)

investment of power generation equipment and the operation mode when waste heat can't be fully utilized should be pay much attention. In Case 2, a gas engine with capacity of 800 kW was selected to supply electricity. Due to the amount of power generation equipment is not enough and the electricity is often insufficient in many cases which results in that it is need to purchase electricity from utility grid. Furthermore, it is cheaper to purchase electricity from utility grid compared to generating electricity with gas when the waste heat can't be used totally. Corresponding to this situation, figure 7-26 also illustrates that the primary energy consumption caused by utility grid take the most percentage in case 2. In Case 3, which concentrates on the environment impact, the primary energy consumption of the power generation facility is the same as that in case 1. The reason is that when the power generation equipment burns natural gas and produces electricity, the CO<sub>2</sub> emission is considerably lower than that of coal.

The component of annual energy cost in the area of each case is shown in Figure 7-27. Annual energy cost includes initial investment of generation facilities, initial investment of heating facilities, electricity cost and gas cost. In case 1 and case 3, fuel cells and solar power generation which have high initial investment are adopted in order to improve energy saving effect and environmental friendliness. Therefore, the annual energy cost of case 1 and case 2 is higher than that of case 2. What' more, in order to achieve better economy performance, two gas engines with low initial investment were introduced into the system which leads to the reduction of energy cost of case 2. Considering that the electricity supply of case 2 is not sufficient as mentioned above and the situation when the exhaust heat can't be fully utilized, the energy charge caused by purchasing electricity from utility grid is high.

The component of annual CO<sub>2</sub> emissions of each case is shown in Figure 7-28. Annual CO<sub>2</sub> emission includes CO<sub>2</sub> emissions from generation facilities, CO<sub>2</sub> emissions from heating facilities, and CO<sub>2</sub> emissions from utility grid. Case 3 is the optimization of environmental impact, fuel cell and photovoltaic power generation with high overall efficiency which result in the annual CO<sub>2</sub> emissions are the smallest. Actually, reducing primary energy consumption is one effective method against CO<sub>2</sub> reduction. Even in Case 1 which is optimization of energy saving, annual CO<sub>2</sub> emission is also small. In Case 2, CO<sub>2</sub> emissions are the largest since the energy savings and environmental impact are not be considered. In addition, the large amount of power purchase also results in the large CO<sub>2</sub> emissions.

Consequently, case 2 which planned distributed energy system under the condition that the economy performance is maximal is the most suitable case for the area to reduce the extra fee caused by using DP. Furthermore, the energy saving performance and environmental performance of case 2 are still higher than that of the traditional energy system.

**CHAPTER SEVEN: ANALYSIS AND EVALUATION OF ELECTRICITY  
DYNAMIC PRICING IN BUILDINGS WITH DIFFERENT ENERGY SAVING  
TECHNOLOGIES**

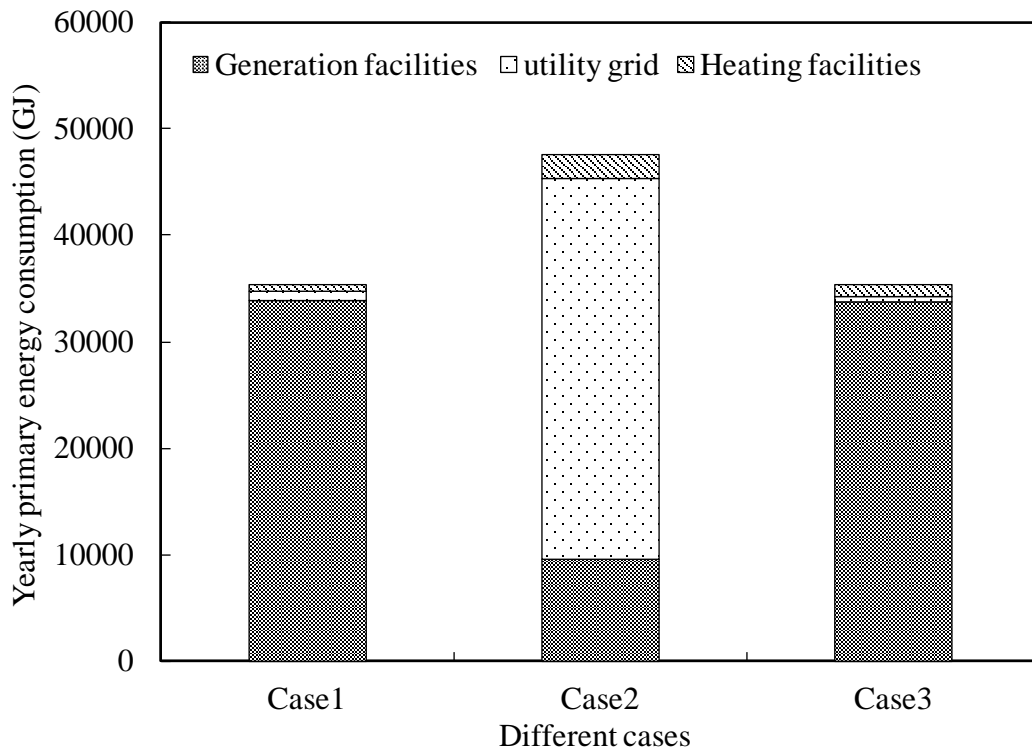

Figure 7-26 Component of yearly primary energy consumption in the area

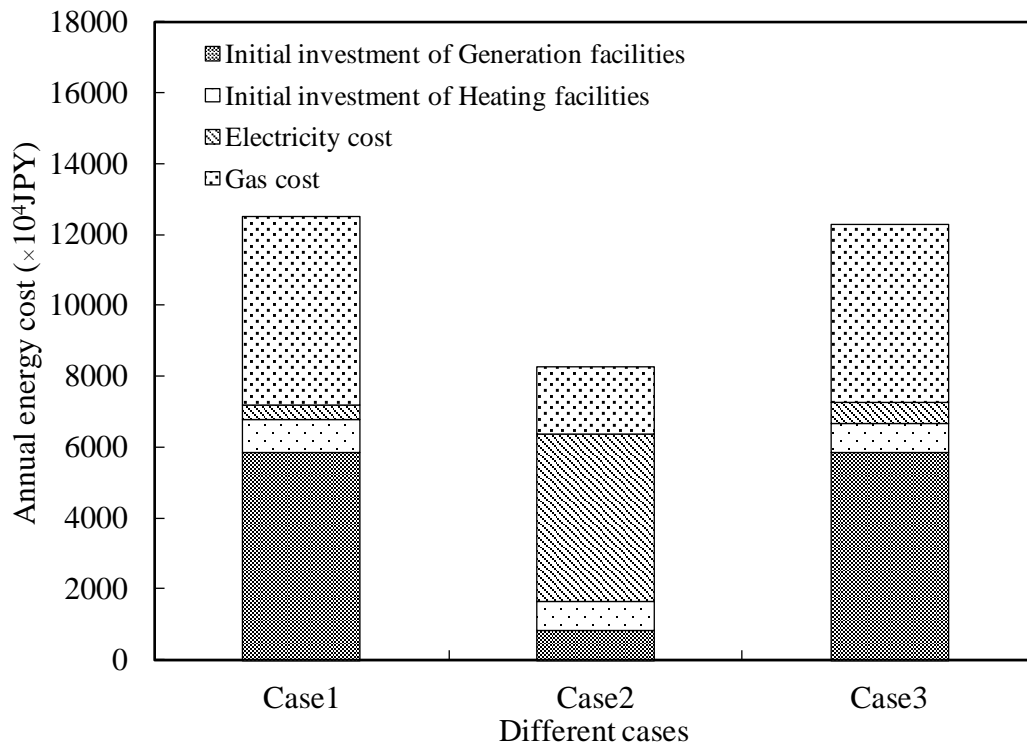

Figure 7-27 Component of annual energy cost in the area

CHAPTER SEVEN: ANALYSIS AND EVALUATION OF ELECTRICITY  
DYNAMIC PRICING IN BUILDINGS WITH DIFFERENT ENERGY SAVING  
TECHNOLOGIES

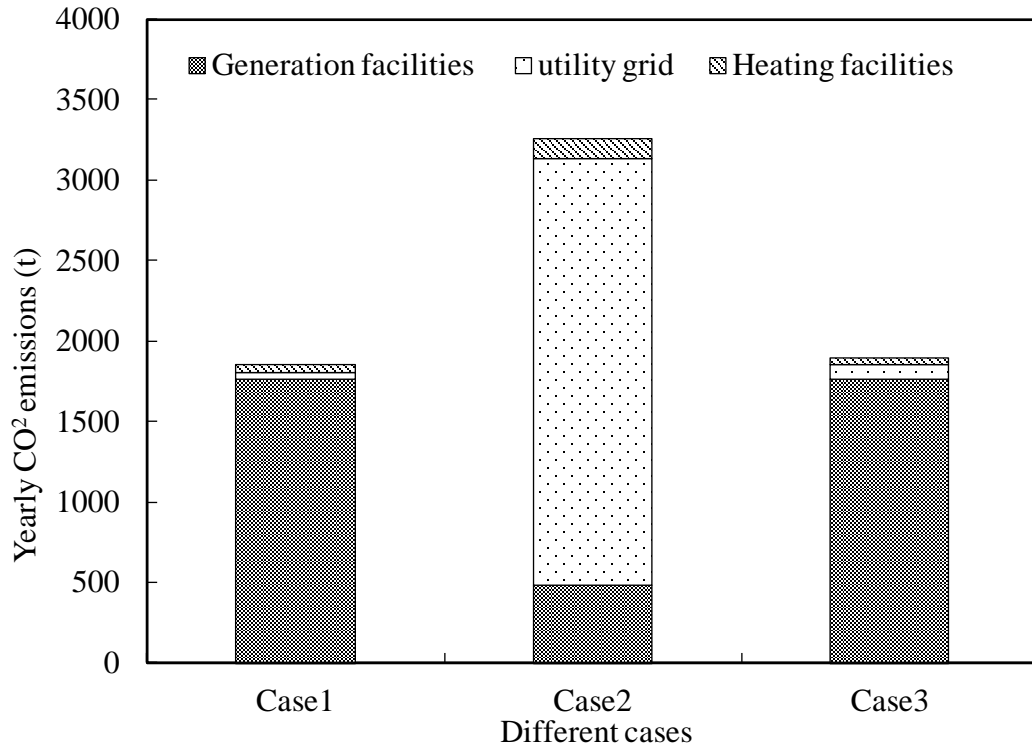

Figure 7-28 Component of yearly CO<sub>2</sub> emissions in the area

## CHAPTER SEVEN: ANALYSIS AND EVALUATION OF ELECTRICITY DYNAMIC PRICING IN BUILDINGS WITH DIFFERENT ENERGY SAVING TECHNOLOGIES

### 7.8 Summary

In order to compensate the tough situation of the contradiction between the deployment of DP and the economy benefit of consumers. Different energy saving technologies were supposed to be introduced into customer side. Through the energy calculation model, draw the conclusion that it has the feasibility to introduce energy saving technologies into customer side to reduce extra fee caused by using DP. According to the analysis in this study, the specific conclusions can be drawn as follows. The simulation result not only suggests the economic effect of different technologies but also the environmental performance and the energy saving effect.

As for introduction of electricity saving technologies (PV or SB) into each building, select PV (case 3) is better than SB in residential house, where, in residential house, only when the initial cost of storage battery reduced to 87% of the present price or the dynamic price of peak period is higher than 206 JPY/kWh, using storage battery to eliminate extra fee caused by utilization of DP began to have feasibility. Furthermore, in hospital, office and hotel, if taking account of economic effect as the main target, equipped with storage battery (case 4) is the best choice to reduce the extra fee caused by DP. If environmental items were mainly considered, the option of introducing photovoltaic (case 3) is better than other options. If economic and environmental effects were all taking into the consideration, introducing both storage battery and photovoltaic (case 5) is a good consideration.

As for introduction of energy saving technologies (distributed energy system) into the area, the energy system equipped with both DP and energy saving technologies will realize 15.3% percentage of annual cost saving. In the case of introducing distributed energy system, the annual energy cost includes initial investment of generation facilities, initial investment of heating facilities, electricity cost and gas cost. In the energy saving performance optimal case and environmental performance optimal case of distributed energy system, fuel cells and solar power generation which have high initial investment and high overall efficiency are adopted in order to improve energy saving effect and environmental friendliness. In the economy performance case, the gas engine which has low initial investment was selected as the only power generation facility, the insufficient electricity demand is supplied by utility grid.



## CHAPTER SEVEN: ANALYSIS AND EVALUATION OF ELECTRICITY DYNAMIC PRICING IN BUILDINGS WITH DIFFERENT ENERGY SAVING TECHNOLOGIES

### REERENCE

- [1] Kyoto Parties with first period (2008-2012) greenhouse gas emissions limitations targets and the percentage change in their carbon dioxide emissions from fuel combustion, [http://en.wikipedia.org/wiki/File:Kyoto\\_Parties\\_with\\_first\\_period\\_\(2008-2012\)\\_greenhouse\\_gas\\_emissions\\_limitations\\_targets\\_and\\_the\\_percentage\\_change\\_in\\_their\\_carbon\\_dioxide\\_emissions\\_from\\_fuel\\_combustion\\_between\\_1990\\_and\\_2009.png](http://en.wikipedia.org/wiki/File:Kyoto_Parties_with_first_period_(2008-2012)_greenhouse_gas_emissions_limitations_targets_and_the_percentage_change_in_their_carbon_dioxide_emissions_from_fuel_combustion_between_1990_and_2009.png)
- [2] Japan's Greenhouse Gas Emissions Efforts Eroded By Fukushima Nuclear Disaster, [http://www.huffingtonpost.com/2012/05/04/japan-greenhouse-gas-emissions\\_n\\_1476580.html](http://www.huffingtonpost.com/2012/05/04/japan-greenhouse-gas-emissions_n_1476580.html)
- [3] As Japan shuts down nuclear power, <http://www.ksl.com/?nid=153&sid=20261309>.
- [4] Yingjun R., Qingrong L., Weiguo Z., Ryan F., Weijun G., Toshiyuki W., Optimal option of distributed generation technologies for various commercial buildings. *Applied Energy* 86 (2009). 1641-1653.
- [5] Qunyin G., Hongbo R., Weijun G., Jianxing R., Integrated assessment of combined cooling heating and power systems under different design and management options for residential buildings in Shanghai. *Energy and Buildings* 51 (2012). 143-152.
- [6] Strachan N., Farrel A., Emissions from distributed vs. centralized generation: the importance of system performance. *Energy Policy* 34 (2006). 2677-2689.
- [7] Ackermann T., Andersson G., Soder L., Distributed generation: a definition. *Electric Power System Res* 57 (2001). 195-204.
- [8] Strachan N., Dowlatabadi H., Distributed generation and distribution utilities. *Energy Policy* 30 (2002). 649-661.
- [9] N.S. Wade, P.C. Lang, P.D. Taylor, P.R. Jones. 2010. "Evaluating the benefits of an electrical energy storage system in a future smart grid". *Energy Policy*. Vol. 38, 7180-7188.
- [10] Jason Leadbetter, Lukas Swan. 2012. "Battery storage system for consumers' electricity peak demand shaving." *Energy and Buildings*. Vol. 55, 685-692.
- [11] XU Dan, DING Qiang, PAN Yi, ZHOU Jing-yang. 2011. "Study on optimizing capacity of storage battery in micro grid system based on economic dispatch." Vol. 39.
- [12] Shisheng Huang, Jingjie Xiao, Joseph F. Pekny, Gintaras V. Reklaitis. "Optimal Residential Solar Photovoltaic Capacity in Grid connected Applications." Volume 30, 2012, 357-361
- [13] Hongbo Ren, Weijun Gao, Yingjun Ruan. "economic optimization and sensitivity analysis of Photovoltaic system in residential buildings." Volume 34, Issue 3, March 2009, 883-889.
- [14] Bhubaneswari Parida , S. Iniyar, Ranko Goic "A review of solar photovoltaic tenologies." Volume 15, Issue 3, April 2011, 1625-1636.



## **CHAPTER EIGHT: CONCLUSIONS AND PROSPECT**

## 8.1 Conclusion

Large amount of shutdowns of nuclear power plants have raised concerns about electric power supply shortages in Japan. The innovation of electric power system is the most pressing priority. Under this background, electricity dynamic pricing is a means of controlling electricity demand and alleviating the tight demand-supply balance. Electricity dynamic pricing increases electricity prices to punitive levels at peak hours on critical days announced beforehand. It is a kind of pricing method which could reflect marginal cost of generating electricity. In response to electricity dynamic pricing strategies, people may change their patterns of electricity usage. However, some kinds of consumers may do not want to change their living habits or they must use electricity in peak hours which has higher electricity price according to the extremely high temperature and the working characteristics. Therefore, the integrated assessment of application of electricity dynamic pricing in buildings is necessary. This research reviewed the present situation of the development status and challenges of smart grids and dynamic pricing, meanwhile, investigated the introduction effect of dynamic pricing from an exploratory analysis of about 200 households and 50 offices that took part in dynamic pricing experiment in Kitakyushu, Japan. Following, this research analyzed the effects of electricity dynamic pricing on the cost performance of buildings in present scenario and demand response scenario. Then, according to the result, it gives an integrated analysis and evaluation of electricity dynamic pricing in buildings with different energy saving technologies. The conclusions of this research are summarized as follows.

Chapter 1, **PREVIOUS STUDY AND PURPOSE OF THE STUDY**, investigated current energy and environmental situations, as well as the electricity market and main electricity pricing system in different countries. In addition, the previous studies about this research are reviewed.

Chapter 2, **SURVEY ON THE DEVELOPMENT STATUS AND CHALLENGES OF SMART GRIDS AND DYNAMIC PRICING IN MAIN DRIVER COUNTRIES**, compares the development backgrounds and infrastructure status of various countries based on five aspects and presents an overview of the smart grid and the electricity dynamic pricing development situations in the main driver countries, discusses the research results produced by smart grid and electricity dynamic pricing projects in different countries, summarizes their achievements and challenges, and provides a roadmap for national policy makers and power companies through which they can better orientates the development of smart grid and electricity dynamic pricing. This chapter also noting that America and Europe have the most similar development mode for SGs and DP and have already entered into a mature period, Japanese model of SG and DP development is a government-led, community-oriented, business-driven approach, China has the most unique SG and DP development structure compared with America, Europe, and Japan. A common problem that these countries face is a lack of clear related standards, such as cost-benefit-sharing mechanism standards and worldwide technical standards.

Chapter 3, **EXPLORATORY ANALYSIS OF KITAKYUSHU RESIDENTS RESPONSE TO DYNAMIC ELECTRICITY PRICING**, introduces the characteristic of Japanese dynamic pricing (DP) model of residents, meanwhile, summarizes the results from an exploratory analysis of about 200 households that took part in DP experiment in Kitakyushu, Japan. The analysis reveals that dynamic pricing was appropriately performed in the reduction of electricity load during peak/event period. In addition, this chapter also discusses dynamic electricity pricing effect

influenced by various factors, such as temperature, floor area of households, price level and residential consciousness, draw the conclusion that the size of load reduction is the largest during extreme temperature which indicating that the important part of load reduction are space heating and cooling; different levels of electricity price have different ability to decrease the peak load, the better dynamic pricing effect appears in higher price level; the awareness of residents could make a good influence on the aspect of utilization of DP, the electricity consumption of consumers that with high energy-saving consciousness is usually higher than that with low energy-saving consciousness.

Chapter 4, **EXPLORATORY ANALYSIS OF KITAKYUSHU RESIDENTS RESPONSE TO DYNAMIC ELECTRICITY PRICING**, selects some kinds of office buildings as a representative to introduce the characteristic of Japanese dynamic pricing (DP) model of office side. Meanwhile, it investigates the energy consumption of target office building, draw the conclusion that, the electricity usage of 2012 and 2013 is lower than that of 2010 and 2011 which due to the energy saving actions after the Great East Japan Earthquake as for all kinds of offices. Furthermore, this chapter estimates the effect of dynamic pricing system on the energy saving of office, concludes the load reduction for participants during the DP time block is occurred. It also discussed the dynamic electricity pricing effect related to temperature and the consciousness of employees. It was found that the gap between the electricity consumption of DP no event day and DP event day was not absolutely increased with the increase of temperature. It affected by many other items. According to the questionnaire of DP demand response investigation which made by Kitakyushu City, it also be proved that there are more than half the offices approve that the business have the priority when compared to response to DP. In addition, due to the loss of control group and experiment samples, standard baseline was also used to analyze the effect of DP. The results show the well peak load reduction effect of DP through the comparison of the load curve of actual electricity use and baseline.

Chapter 5, **EVALUATION METHODS FOR ELECTRICITY DYNAMIC PRICING SYSTEM AND ENERGY SAVING TECHNOLOGIES**, proposes the evaluation system for the utilization of electricity dynamic pricing and energy saving technology in order to support its well introduction and deployment, introduces the main assessment criteria to estimate the overall performance of introducing energy saving technologies into the different alternative energy system of various buildings.

Chapter 6, **ANALYSIS OF THE EFFECTS OF ELECTRICITY DYNAMIC PRICING ON THE COST PERFORMANCE OF BUILDINGS IN PRESENT SCENARIO AND DEMAND RESPONSE SCENARIO**, investigates the effects of dynamic pricing system on the cost performance of different buildings in two scenarios, present scenario and demand response scenario. In the present scenario, this chapter gets the conclusion that, as for common consumers, dynamic pricing can't bring economic benefit to them if they have no obvious demand response. In the demand response scenario, it can be drawn that even simple electricity saving actions, it also can realize amount of cost reduction for consumers who using dynamic pricing.

Chapter 7, **ANALYSIS AND EVALUATION OF ELECTRICITY DYNAMIC PRICING IN BUILDINGS WITH DIFFERENT ENERGY SAVING TECHNOLOGIES**, supposes the case that introducing different energy saving technologies into customer side. Through the energy

calculation model, draw the conclusion that it has the feasibility to introduce energy saving technologies into customer side to reduce extra fee caused by using DP. As for introduction of electricity saving technologies (PV or SB) into each building, select PV is better than SB in residential house, however, in hospital, office and hotel, different import objectives will result in different choice of facilities. As for introduction of energy saving technologies (distributed energy system) into the area, the energy system equipped with both DP and energy saving technologies will realize 15.3% percentage of annual cost saving. In the energy saving performance optimal case and environmental performance optimal case of distributed energy system, fuel cells and solar power generation which have high initial investment and high overall efficiency are adopted in order to improve energy saving effect and environmental friendliness. In the economy performance case, the gas engine which has low initial investment was selected as the only power generation facility. The insufficient electricity demand is supplied by utility grid.